

Fișă tehnică | Număr articol: 2000-1307

3-conductor ground terminal block; 1 mm²; suitable for Ex e II applications;
side and center marking; for DIN-rail 35 x 15 and 35 x 7.5; Push-in CAGE
CLAMP®; 1,00 mm²; green-yellow

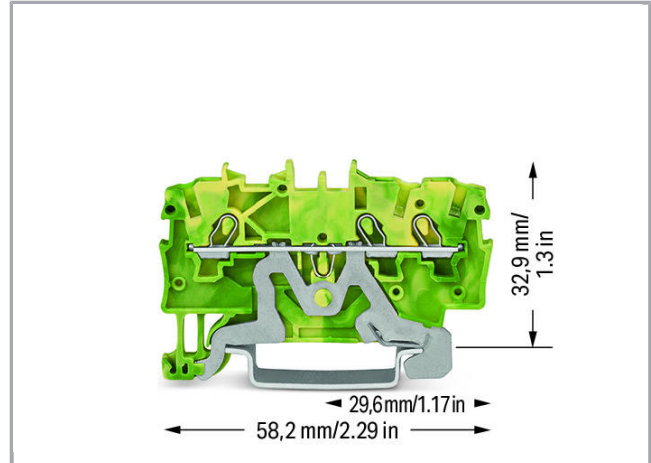

www.wago.com/2000-1307

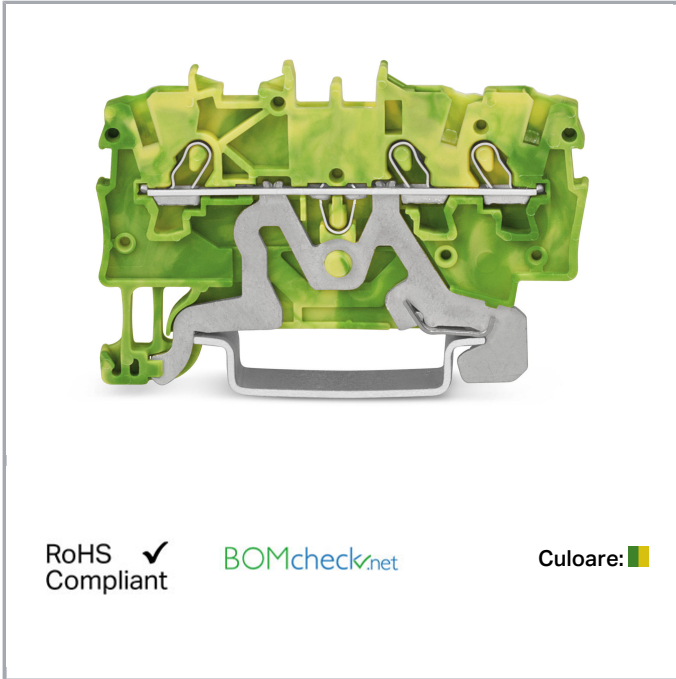

RoHS Compliant

BOMcheck.net

Culoare:

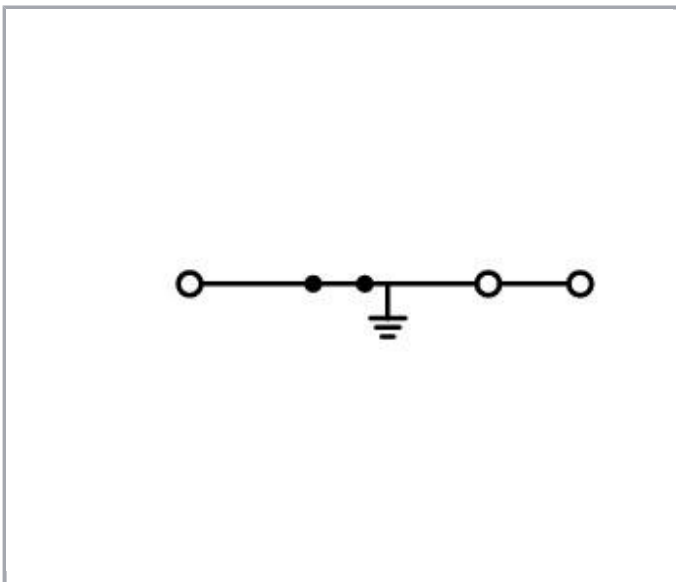

Date

Electrical data

Supus modificărilor.

WAGO Kontakttechnik GmbH & Co. KG
/Representative Office Romania
Sos. Pipera-Tunari nr. 1/1
building 1, 2nd floor | 077190 Voluntari, Ilfov
Tel.: +40-(0)31 421 85 68 | Email: info-RO@wago.com

Aveți întrebări despre produsele noastre?

Vă stăm la dispoziție pentru preluarea apelului la +40 (0) 31 421 85 68.



Ratings per IEC/EN 60664-1

Ratings per	IEC/EN 60947-7-2
-------------	------------------

Connection data

Connection technology	Push-in CAGE CLAMP®
Actuation type	Push-in Open Tool Slot
Connectable conductor materials	Copper
Nominal cross-section	1 mm ²
Solid conductor	0,14 ... 1,5 mm ² / 24 ... 16 AWG
Solid conductor; push-in termination	0,5 ... 1,5 mm ² / 20 ... 16 AWG
Fine-stranded conductor	0,14 ... 1,5 mm ² / 24 ... 16 AWG
Fine-stranded conductor; with insulated ferrule	0,5 ... 0,75 mm ² / 20 ... 18 AWG
Fine-stranded conductor; with ferrule; push-in termination	0,5 ... 0,75 mm ² / 20 ... 18 AWG
Strip length	9 ... 11 mm / 0.35 ... 0.43 inch
Total number of connection points	3
Total number of potentials	1
Number of levels	1
Wiring type	Front-entry wiring
Note (conductor cross-section)	Depending on the conductor characteristic, a conductor with a smaller cross section can also be inserted via push-in termination.
Number of jumper slots	2

Geometrical Data

Width	3,5 mm / 0.138 inch
Height from upper-edge of DIN-rail	32,9 mm / 1.295 inch
Depth	58,2 mm / 2.291 inch

Mechanical data

Design	horizontal
Mounting type	DIN-35 rail
Marking level	Center/side marking

Material Data

Color	green-yellow
-------	--------------

Supus modificărilor.

WAGO Kontakttechnik GmbH & Co. KG
/Representative Office Romania
Sos. Pipera-Tunari nr. 1/1
building 1, 2nd floor | 077190 Voluntari, Ilfov
Tel.: +40-(0)31 421 85 68 | Email: info-RO@wago.com

Aveți întrebări despre produsele noastre?
Vă stăm la dispoziție pentru preluarea apelului la +40 (0) 31 421 85 68.

Insulation material	Polyamide 66 (PA 66)
Fire load	0,083 MJ
Weight	6,5 g

Commercial data



Product Group	22 (TOPJOB S)
Packaging type	BOX
Country of origin	CN
GTIN	4045454966904
Customs tariff number	85369010000

Aprobări / certificate

Ex-Approvals

Emblemă	Aprobare	Text de aprobare suplimentar	Nume certificat
	AEx Underwriters Laboratories Inc.	UL 60079	E185892
	ATEX Physikalisch Technische Bundesanstalt	EN 60079	PTB 11 ATEX 1041 U (II 2 G Ex e IIC GB / I M 2 Ex e I Mb)

Country specific Approvals

Emblemă	Aprobare	Text de aprobare suplimentar	Nume certificat
	CCA DEKRA Certification B.V.	EN 60947	71- 102841
	CSA DEKRA Certification B.V.	C22.2 No. 158	2130762

Ship Approvals

Emblemă	Aprobare	Text de aprobare suplimentar	Nume certificat

Supus modificărilor.

	ABS American Bureau of Shipping	EN 60947	20- HG1941090- PDA
	BV Bureau Veritas S.A.	EN 60947	38586/A0 BV
	DNV GL Det Norske Veritas, Germanischer Lloyd	-	TAE00001V2
	LR Lloyds Register	EN 60947	91/20112 (E9)

Counterpart

Produse compatibile

Protective Warning Marker



Nr. articol: 2000-115

Protective warning marker; with high-voltage symbol, black; for 5 terminal blocks; yellow

www.wago.com/2000-115

Push-In type wire jumper



Nr. articol: 2009-402

Push-in type wire jumper; insulated; wire length 60 mm; Conductor cross section 0.75 mm²; suitable for 2000 and 2020 Series rail-mounted terminal blocks; gray

www.wago.com/2009-402



Nr. articol: 2009-404

Push-in type wire jumper; insulated; wire length 110 mm; Conductor cross section 0.75 mm²; suitable for 2000 and 2020 Series rail-mounted terminal blocks; gray

www.wago.com/2009-404



Nr. articol: 2009-406

Push-in type wire jumper; insulated; wire length 250 mm; Conductor cross section 0.75 mm²; suitable for 2000 and 2020 Series rail-mounted terminal blocks; gray

















www.wago.com/2009-406

End plate















Supus modificărilor.

WAGO Kontakttechnik GmbH & Co. KG
/Representative Office Romania
Sos. Pipera-Tunari nr. 1/1
building 1, 2nd floor | 077190 Voluntari, Ilfov
Tel.: +40-(0)31 421 85 68 | Email: info-RO@wago.com

Aveți întrebări despre produsele noastre?
Vă stăm la dispoziție pentru preluarea apelului la +40 (0) 31 421 85 68.

	Nr. articol: 2000-1391 End and intermediate plate; 0.7 mm thick; gray	www.wago.com/2000-1391
	Nr. articol: 2000-1392 End and intermediate plate; 0.7 mm thick; orange	www.wago.com/2000-1392
	Nr. articol: 209-191 Separator for Ex e/Ex i applications; 3 mm thick; 120 mm wide; orange	www.wago.com/209-191
check		
	Nr. articol: 2000-510 TOPJOB®S L-type test plug module; modular; for jumper contact slot; 1,00 mm ² ; gray	www.wago.com/2000-510
	Nr. articol: 2000-511 TOPJOB®S L-type test plug module; modular; for jumper contact slot; 1-pole; 1,00 mm ² ; gray	www.wago.com/2000-511
	Nr. articol: 2000-549 Spacer module; modular; e.g., for bridging commoned terminal blocks; gray	www.wago.com/2000-549
	Nr. articol: 2000-552 Modular TOPJOB®S connector; modular; for jumper contact slot; 2-pole; 1,00 mm ² ; gray	www.wago.com/2000-552
	Nr. articol: 2000-553 Modular TOPJOB®S connector; modular; for jumper contact slot; 3-pole; 1,00 mm ² ; gray	www.wago.com/2000-553
	Nr. articol: 2000-554 Modular TOPJOB®S connector; modular; for jumper contact slot; 4-pole; 1,00 mm ² ; gray	www.wago.com/2000-554
	Nr. articol: 2000-555 Modular TOPJOB®S connector; modular; for jumper contact slot; 5-pole; 1,00 mm ² ; gray	www.wago.com/2000-555
	Nr. articol: 2000-556 Modular TOPJOB®S connector; modular; for jumper contact slot; 6-pole; 1,00 mm ² ; gray	www.wago.com/2000-556
	Nr. articol: 2000-557 Modular TOPJOB®S connector; modular; for jumper contact slot; 7-pole; 1,00 mm ² ; gray	www.wago.com/2000-557
	Nr. articol: 2000-558 Modular TOPJOB®S connector; modular; for jumper contact slot; 8-pole; 1,00 mm ² ; gray	www.wago.com/2000-558
	Nr. articol: 2000-559 Modular TOPJOB®S connector; modular; for jumper contact slot; 9-pole; 1,00 mm ² ; gray	www.wago.com/2000-559
	Nr. articol: 2000-560 Modular TOPJOB®S connector; modular; for jumper contact slot; 10-pole; 1,00 mm ² ; gray	www.wago.com/2000-560
	Nr. articol: 2009-174 Test plug adapter; for 4 mm Ø test plugs; for testing TOPJOB®S rail-mounted terminal blocks; gray	www.wago.com/2009-174
	Nr. articol: 2009-182 Testing tap; for max. 2.5 mm ² ; tool-free connection for individual test wires 0.08 - 2.5 mm; gray	www.wago.com/2009-182















Supus modificărilor.

	Nr. articol: 210-136 Test plug; 2 mm Ø; with 500 mm cable; red	www.wago.com/210-136
	Nr. articol: 210-137 Test plug; 2.3 mm Ø; with 500 mm cable; yellow	www.wago.com/210-137
ferrule		
	Nr. articol: 216-241 Ferrule; Sleeve for 0.5 mm ² / 20 AWG; insulated; electro-tin plated; electrolytic copper; gastight crimped; acc. to DIN 46228, Part 4/09.90; white	www.wago.com/216-241
	Nr. articol: 216-242 Ferrule; Sleeve for 0.75 mm ² / 18 AWG; insulated; electro-tin plated; electrolytic copper; gastight crimped; acc. to DIN 46228, Part 4/09.90; gray	www.wago.com/216-242
	Nr. articol: 216-243 Ferrule; Sleeve for 1 mm ² / AWG 18; insulated; electro-tin plated; electrolytic copper; gastight crimped; acc. to DIN 46228, Part 4/09.90; red	www.wago.com/216-243
Marking accessories		
	Nr. articol: 2009-110 Marking strips; on reel; not stretchable; plain; snap-on type; white	www.wago.com/2009-110
	Nr. articol: 2009-113 WMB-Inline; for Smart Printer; 2300 pieces on roll; plain; snap-on type; white	www.wago.com/2009-113
	Nr. articol: 2009-113/000-002 WMB-Inline; for Smart Printer; 2300 pieces on roll; plain; snap-on type; yellow	www.wago.com/2009-113/000-002
	Nr. articol: 2009-113/000-005 WMB-Inline; for Smart Printer; 2300 pieces on roll; plain; snap-on type; red	www.wago.com/2009-113/000-005
	Nr. articol: 2009-113/000-006 WMB-Inline; for Smart Printer; 2300 pieces on roll; plain; snap-on type; blue	www.wago.com/2009-113/000-006
	Nr. articol: 2009-113/000-007 WMB-Inline; for Smart Printer; 2300 pieces on roll; plain; snap-on type; gray	www.wago.com/2009-113/000-007
	Nr. articol: 2009-113/000-012 WMB-Inline; for Smart Printer; 2300 pieces on roll; plain; snap-on type; orange	www.wago.com/2009-113/000-012
	Nr. articol: 2009-113/000-017 WMB-Inline; for Smart Printer; 2300 pieces on roll; plain; snap-on type; light green	www.wago.com/2009-113/000-017
	Nr. articol: 2009-113/000-023 WMB-Inline; for Smart Printer; 2300 pieces on roll; plain; snap-on type; green	www.wago.com/2009-113/000-023















Supus modificărilor.

WAGO Kontakttechnik GmbH & Co. KG
/Representative Office Romania
Sos. Pipera-Tunari nr. 1/1
building 1, 2nd floor | 077190 Voluntari, Ilfov
Tel.: +40-(0)31 421 85 68 | Email: info-RO@wago.com















Aveți întrebări despre produsele noastre?
Vă stăm la dispoziție pentru preluarea apelului la +40 (0) 31 421 85 68.

	Nr. articol: 2009-113/000-024 WMB-Inline; for Smart Printer; 2300 pieces on roll; plain; snap-on type; violet	www.wago.com/2009-113/000-024
	Nr. articol: 2009-191 Group marker carrier	www.wago.com/2009-191
	Nr. articol: 793-3501 WMB marking card; as card; plain; snap-on type; white	www.wago.com/793-3501
Carrier rail		
	Nr. articol: 210-112 Steel carrier rail; 35 x 7.5 mm; 1 mm thick; 2 m long; slotted; according to EN 60715; "Hole width 25 mm	www.wago.com/210-112
	Nr. articol: 210-113 Steel carrier rail; 35 x 7.5 mm; 1 mm thick; 2 m long; unslotted; according to EN 60715	www.wago.com/210-113
	Nr. articol: 210-114 Steel carrier rail; 35 x 15 mm; 1.5 mm thick; 2 m long; unslotted; similar to EN 60715	www.wago.com/210-114
	Nr. articol: 210-115 Steel carrier rail; 35 x 7.5 mm; 1 mm thick; 2 m long; slotted; according to EN 60715; "Hole width 18 mm	www.wago.com/210-115
	Nr. articol: 210-118 Steel carrier rail; 35 x 15 mm; 2.3 mm thick; 2 m long; unslotted; according to EN 60715	www.wago.com/210-118
	Nr. articol: 210-196 Aluminum carrier rail; 35 x 8.2 mm; 1.6 mm thick; 2 m long; unslotted; similar to EN 60715; silver-colored	www.wago.com/210-196
	Nr. articol: 210-197 Steel carrier rail; 35 x 15 mm; 1.5 mm thick; 2 m long; slotted; similar to EN 60715	www.wago.com/210-197
	Nr. articol: 210-198 Copper carrier rail; 35 x 15 mm; 2.3 mm thick; 2 m long; unslotted; according to EN 60715; copper-colored	www.wago.com/210-198
Jumper		
	Nr. articol: 2000-402 Push-in type jumper bar; insulated; 2-way; Nominal current 14 A; light gray	www.wago.com/2000-402
	Nr. articol: 2000-402/000-005 Push-in type jumper bar; insulated; 2-way; Nominal current 14 A; red	www.wago.com/2000-402/000-005
	Nr. articol: 2000-402/000-006 Push-in type jumper bar; insulated; 2-way; Nominal current 14 A; blue	www.wago.com/2000-402/000-006
	Nr. articol: 2000-402/000-018 Push-in type jumper bar; insulated; 2-way; Nominal current 14 A; yellow-green	www.wago.com/2000-402/000-018
	Nr. articol: 2000-403	













Supus modificărilor.

	Push-in type jumper bar; insulated; 3-way; Nominal current 14 A; light gray	www.wago.com/2000-403
	Nr. articol: 2000-403/000-005 Push-in type jumper bar; insulated; 3-way; Nominal current 14 A; red	www.wago.com/2000-403/000-005
	Nr. articol: 2000-403/000-006 Push-in type jumper bar; insulated; 3-way; Nominal current 14 A; blue	www.wago.com/2000-403/000-006
	Nr. articol: 2000-404 Push-in type jumper bar; insulated; 4-way; Nominal current 14 A; light gray	www.wago.com/2000-404
	Nr. articol: 2000-404/000-005 Push-in type jumper bar; insulated; 4-way; Nominal current 14 A; red	www.wago.com/2000-404/000-005
	Nr. articol: 2000-404/000-006 Push-in type jumper bar; insulated; 4-way; Nominal current 14 A; blue	www.wago.com/2000-404/000-006
	Nr. articol: 2000-405 Push-in type jumper bar; insulated; 5-way; Nominal current 14 A; light gray	www.wago.com/2000-405
	Nr. articol: 2000-405/000-005 Push-in type jumper bar; insulated; 5-way; Nominal current 14 A; red	www.wago.com/2000-405/000-005
	Nr. articol: 2000-405/000-006 Push-in type jumper bar; insulated; 5-way; Nominal current 14 A; blue	www.wago.com/2000-405/000-006
	Nr. articol: 2000-405/011-000 Star point jumper; insulated; 3-way (1-3-5); IN = IN terminal block; light gray	www.wago.com/2000-405/011-000
	Nr. articol: 2000-406 Push-in type jumper bar; insulated; 6-way; Nominal current 14 A; light gray	www.wago.com/2000-406
	Nr. articol: 2000-406/000-005 Push-in type jumper bar; insulated; 6-way; Nominal current 14 A; red	www.wago.com/2000-406/000-005
	Nr. articol: 2000-406/000-006 Push-in type jumper bar; insulated; 6-way; Nominal current 14 A; blue	www.wago.com/2000-406/000-006
	Nr. articol: 2000-406/020-000 Delta jumper; insulated; 1-2 3-4 5-6; IN = IN terminal block; light gray	www.wago.com/2000-406/020-000

Supus modificărilor.

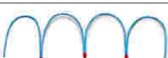
	Nr. articol: 2000-407 Push-in type jumper bar; insulated; 7-way; Nominal current 14 A; light gray	www.wago.com/2000-407
	Nr. articol: 2000-407/000-005 Push-in type jumper bar; insulated; 7-way; Nominal current 14 A; red	www.wago.com/2000-407/000-005
	Nr. articol: 2000-407/000-006 Push-in type jumper bar; insulated; 7-way; Nominal current 14 A; blue	www.wago.com/2000-407/000-006
	Nr. articol: 2000-408 Push-in type jumper bar; insulated; 8-way; Nominal current 14 A; light gray	www.wago.com/2000-408
	Nr. articol: 2000-408/000-005 Push-in type jumper bar; insulated; 8-way; Nominal current 14 A; red	www.wago.com/2000-408/000-005
	Nr. articol: 2000-408/000-006 Push-in type jumper bar; insulated; 8-way; Nominal current 14 A; blue	www.wago.com/2000-408/000-006
	Nr. articol: 2000-409 Push-in type jumper bar; insulated; 9-way; Nominal current 14 A; light gray	www.wago.com/2000-409
	Nr. articol: 2000-409/000-005 Push-in type jumper bar; insulated; 9-way; Nominal current 14 A; red	www.wago.com/2000-409/000-005
	Nr. articol: 2000-409/000-006 Push-in type jumper bar; insulated; 9-way; Nominal current 14 A; blue	www.wago.com/2000-409/000-006
	Nr. articol: 2000-410 Push-in type jumper bar; insulated; 10-way; Nominal current 14 A; light gray	www.wago.com/2000-410
	Nr. articol: 2000-410/000-005 Push-in type jumper bar; insulated; 10-way; Nominal current 14 A; red	www.wago.com/2000-410/000-005
	Nr. articol: 2000-410/000-006 Push-in type jumper bar; insulated; 10-way; Nominal current 14 A; blue	www.wago.com/2000-410/000-006
	Nr. articol: 2000-433 Push-in type jumper bar; insulated; from 1 to 3; Nominal current 14 A; light gray	www.wago.com/2000-433
	Nr. articol: 2000-433/000-005 Push-in type jumper bar; insulated; from 1 to 3; Nominal current 14 A; red	www.wago.com/2000-433/000-005
	Nr. articol: 2000-433/000-006 Push-in type jumper bar; insulated; from 1 to 3; Nominal current 14 A; blue	www.wago.com/2000-433/000-006

Supus modificărilor.

	Nr. articol: 2000-434 Push-in type jumper bar; insulated; from 1 to 4; Nominal current 14 A; light gray	www.wago.com/2000-434
	Nr. articol: 2000-435 Push-in type jumper bar; insulated; from 1 to 5; Nominal current 14 A; light gray	www.wago.com/2000-435
	Nr. articol: 2000-436 Push-in type jumper bar; insulated; from 1 to 6; Nominal current 14 A; light gray	www.wago.com/2000-436
	Nr. articol: 2000-437 Push-in type jumper bar; insulated; from 1 to 7; Nominal current 14 A; light gray	www.wago.com/2000-437
	Nr. articol: 2000-438 Push-in type jumper bar; insulated; from 1 to 8; Nominal current 14 A; light gray	www.wago.com/2000-438
	Nr. articol: 2000-439 Push-in type jumper bar; insulated; from 1 to 9; Nominal current 14 A; light gray	www.wago.com/2000-439
	Nr. articol: 2000-440 Push-in type jumper bar; insulated; from 1 to 10; Nominal current 14 A; light gray	www.wago.com/2000-440
	Nr. articol: 210-103 Wire commoning chain; insulated; 50 connections; black	www.wago.com/210-103
	Nr. articol: 210-123 Wire commoning chain; insulated; 50 connections	www.wago.com/210-123
tools		
	Nr. articol: 210-647 Operating tool; Blade: 2.5 x 0.4 mm; with a partially insulated shaft	www.wago.com/210-647
	Nr. articol: 210-648 Operating tool; Blade: 2.5 x 0.4 mm; with a partially insulated shaft; angled; short	www.wago.com/210-648
	Nr. articol: 210-719 Operating tool; Blade: 2.5 x 0.4 mm; with a partially insulated shaft	www.wago.com/210-719

Descărcări

Documentation

Additional Information

Technical explanations	Apr 3, 2019	pdf 2,1 MB	Descărcare
------------------------	-------------	---------------	------------

CAD/CAE-Data

CAD data

2D/3D Models 2000-1307	URL	Descărcare
------------------------	-----	------------

Supus modificărilor.

WAGO Kontakttechnik GmbH & Co. KG
/Representative Office Romania
Sos. Pipera-Tunari nr. 1/1
building 1, 2nd floor | 077190 Voluntari, Ilfov
Tel.: +40-(0)31 421 85 68 | Email: info-RO@wago.com

Aveți întrebări despre produsele noastre?
Vă stăm la dispoziție pentru preluarea apelului la +40 (0) 31 421 85 68.

CAE data

EPLAN Data Portal 2000-1307

URL

Descărcare

WSCAD Universe 2000-1307

URL

Descărcare

Installation Notes

Conductor termination

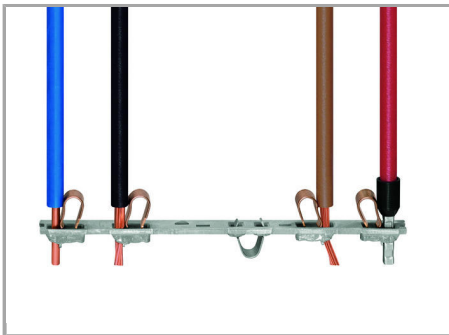

All conductor types at a glance

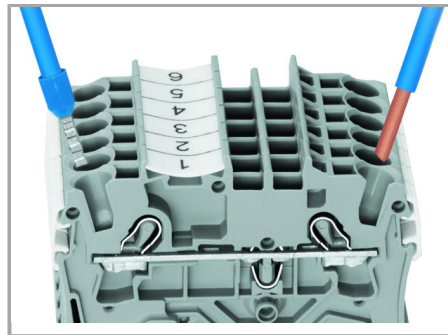

Terminating solid and ferruled conductors via push-in connection.

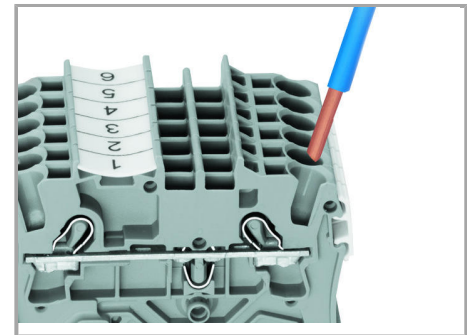

Inserting conductors via push-in termination.

Solid conductors with cross-sections from either one size above, or up to two sizes below, the rated cross-section can be simply pushed in – no tools needed.

Supus modificărilor.



Inserting a conductor via operating tool.

Connecting fine-stranded conductors without ferrules, or small cross-sectional conductors that cannot be pushed in, is performed similarly to the original CAGE CLAMP® – just use an operating tool.

The smart feature:

To open the clamp, the operating tool is inserted vertically. The conductor entry is less than 15 degrees for easier wiring.

Commoning

Supus modificărilor.



The push-in type jumper bar system is based on the common plug and socket principle. Each terminal block is spring-loaded with a double socket and a resilient CrNi steel spring. The jumper contact material is pure electrolytic copper, which allows for an extremely small design capable of carrying the full-rated current of the terminal block. Ground terminal blocks can also be commoned using the same jumper system. Custom jumpers are created by breaking and removing jumper contacts (2000, 2001, 2002, 2004 Series).

Removing a push-in type jumper bar.

Insert the operating tool between the jumper and the partition wall of the dual jumper slots, then lift up the jumper.

Place the operating tool in the center of jumpers up to five contacts (see above), or alternately on both sides for jumpers with more than five contacts.

Jumpered

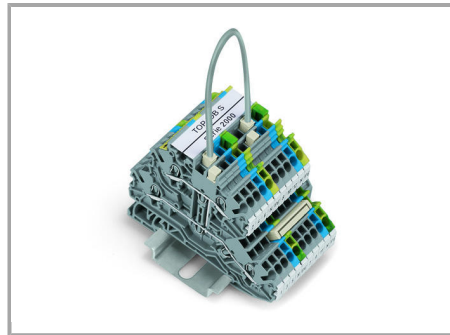
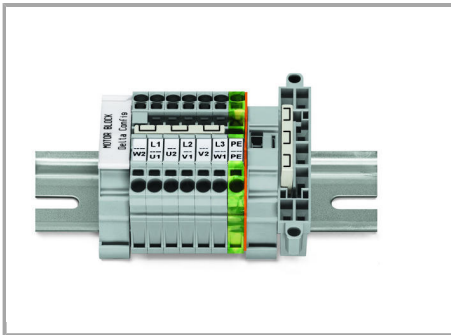

This delta jumper has been specially developed to create a delta configuration and is used on motor terminal boards equipped with TOPJOB® S rail-mount terminal blocks.

Push down the wire jumper (2009-402) until fully inserted. Lift the jumper with an operating tool for rewiring.

Testing

Supus modificărilor.

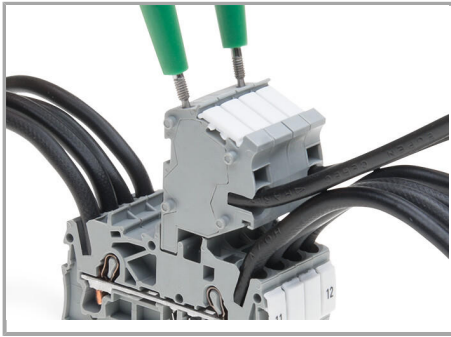

TOPJOB® S Connectors with a 2 mm Ø test socket for testing voltage via 2-pole voltage tester

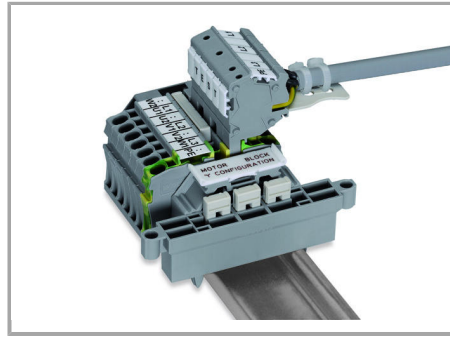

Rail-mount terminal block assembly for electric motor wiring

Marking

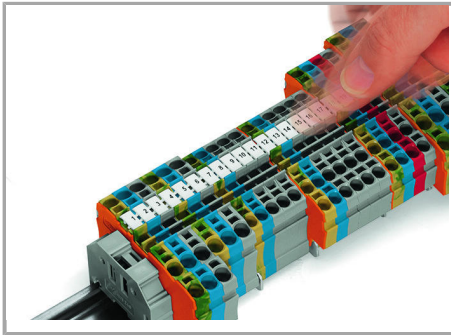

Snapping WMB Inline markers into marker slots.

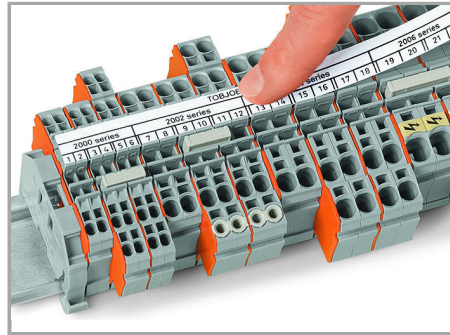

Familie de produse

TOPJOB® S

TOPJOB® S: In various industrial applications and modern building installations, WAGO's wide and versatile range of rail-mount terminal blocks provides more than just reliable electrical connections.

[Afișare globală produse din familie.](#)

Supus modificărilor.