

Fișă tehnică | Număr articol: 745-655/006-000

PCB terminal block; 16 mm<sup>2</sup>; Pin spacing 20 mm; 5-pole; CAGE CLAMP®; commoning option; 16,00 mm<sup>2</sup>; gray

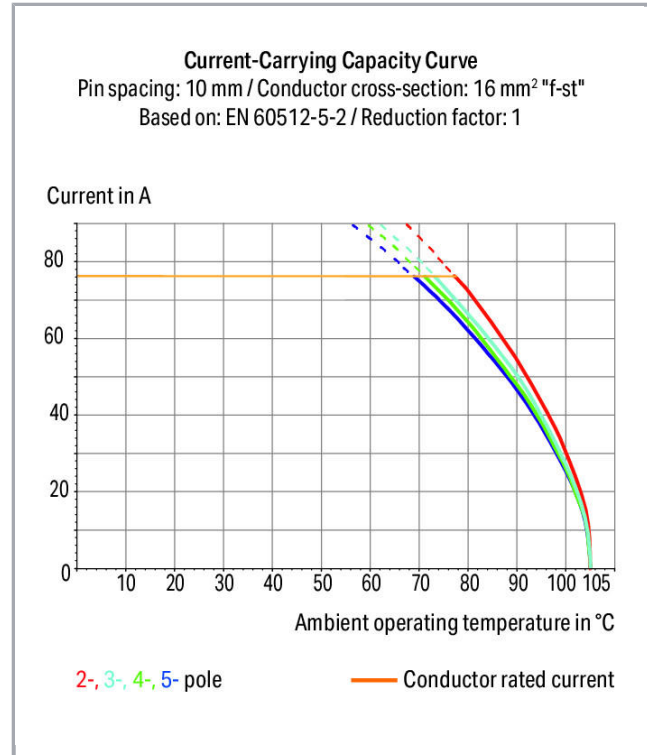

[www.wago.com/745-655/006-000](http://www.wago.com/745-655/006-000)

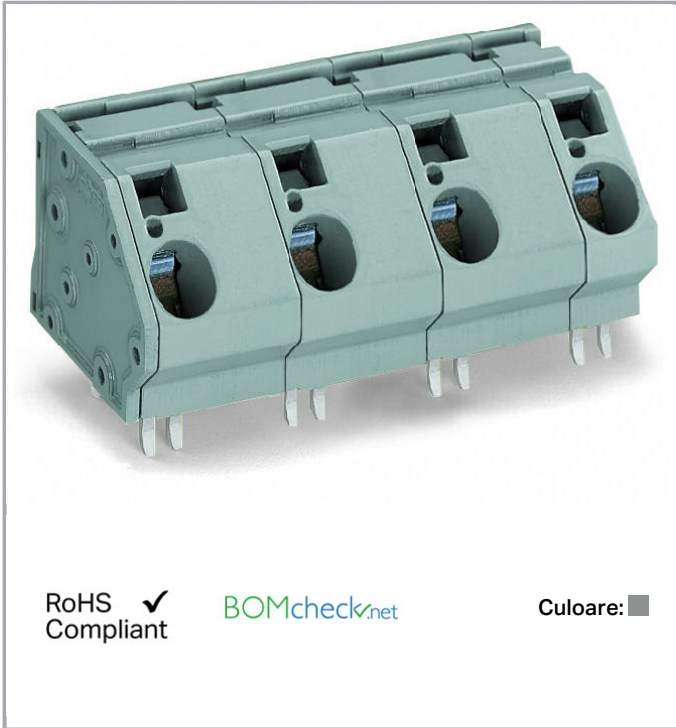

Supus modificărilor.

WAGO Kontakttechnik GmbH & Co. KG  
/Representative Office Romania  
Sos. Pipera-Tunari nr. 1/1  
building 1, 2nd floor | 077190 Voluntari, Ilfov  
Tel.: +40-(0)31 421 85 68 | Email: info-RO@wago.com

Aveți întrebări despre produsele noastre?  
Vă stăm la dispoziție pentru preluarea apelului la +40 (0) 31 421 85 68.

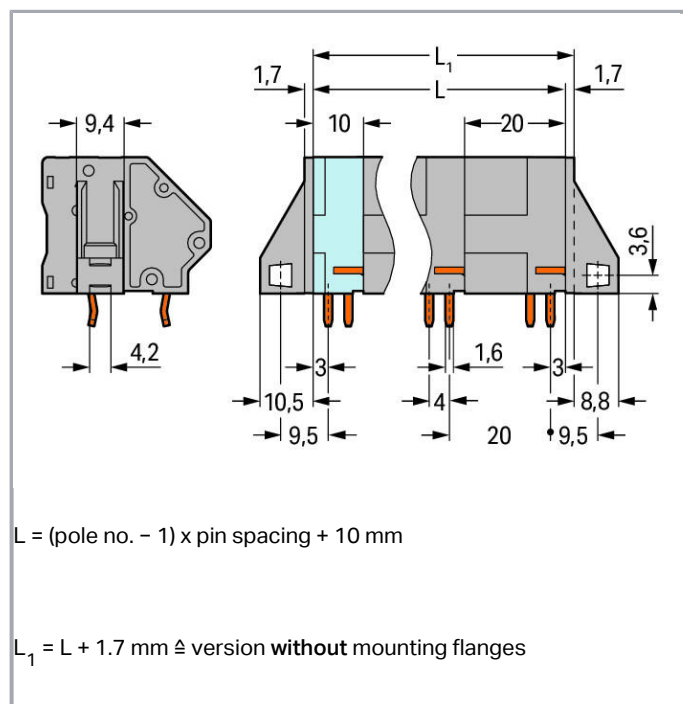

## Descriere articol

- PCB terminal strips with screwdriver-actuated CAGE CLAMP® connection
- Versions with Ex approval
- Unrestricted UL approval up to 600 V with 20 mm pin spacing
- Common and distribute potentials via comb-style jumper bars
- Four solder pins for high mechanical stability
- Integrated testing tap
- Marker slot for Mini-WSB markers

## Date

### Electrical data

### Ratings per IEC/EN 60664-1

| Ratings per                 | IEC/EN 60664-1 |
|-----------------------------|----------------|
| Nominal voltage (III/3)     | 1000 V         |
| Rated surge voltage (III/3) | 12 kV          |
| Rated voltage (III/2)       | 1000 V         |
| Rated surge voltage (III/2) | 12 kV          |
| Nominal voltage (II/2)      | 1000 V         |

Supus modificărilor.

WAGO Kontakttechnik GmbH & Co. KG  
 /Representative Office Romania  
 Sos. Pipera-Tunari nr. 1/1  
 building 1, 2nd floor | 077190 Voluntari, Ilfov  
 Tel.: +40-(0)31 421 85 68 | Email: info-RO@wago.com

Aveți întrebări despre produsele noastre?  
 Vă stăm la dispoziție pentru preluarea apelului la +40 (0) 31 421 85 68.



|                            |  |
|----------------------------|--|
| Rated surge voltage (II/2) | 12 kV  |
| Rated current              | 76 A   |
| Legend (ratings)           | (III / 2) $\triangleq$ Overvoltage category III / Pollution degree 2 |

### Approvals per UL 1059

|                                |         |
|--------------------------------|---------|
| Rated voltage UL (Use Group B) | 600 V   |
| Rated current UL (Use Group B) | 65 A    |
| Rated voltage UL (Use Group C) | 600 V   |
| Rated current UL (Use Group C) | 65 A    |
| Approvals per                  | UL 1059 |

### Approvals per CSA

|                                 |       |
|---------------------------------|-------|
| Rated voltage CSA (Use Group B) | 600 V |
| Rated current CSA (Use Group B) | 65 A  |
| Rated voltage CSA (Use Group C) | 600 V |
| Rated current CSA (Use Group C) | 65 A  |

### Connection data

|   |   |
|---|---|
| Connection technology                             | CAGE CLAMP®                               |
| Actuation type                                    | Operating tool                            |
| Solid conductor                                   | 0,2 ... 16 mm <sup>2</sup> / 24 ... 6 AWG |
| Fine-stranded conductor                           | 0,2 ... 16 mm <sup>2</sup> / 24 ... 6 AWG |
| Fine-stranded conductor; with insulated ferrule   | 0,25 ... 10 mm <sup>2</sup>               |
| Fine-stranded conductor; with uninsulated ferrule | 0,25 ... 10 mm <sup>2</sup>               |
| Strip length                                      | 12 ... 13 mm / 0.47 ... 0.51 inch         |
| Conductor connection direction to PCB             | 45°                                       |
| Pole No.  | 5   |
| Total number of connection points                 | 5   |
| Total number of potentials                        | 5   |
| Number of connection types                        | 1   |
| Number of levels                                  | 1   |
| Number of jumper slots                            | 1   |

### Geometrical Data

|             |                     |
|-------------|---------------------|
| Pin spacing | 20 mm / 0.787 inch  |
| Width       | 91,7 mm / 3.61 inch |

Supus modificărilor.

WAGO Kontakttechnik GmbH & Co. KG  
 /Representative Office Romania  
 Sos. Pipera-Tunari nr. 1/1  
 building 1, 2nd floor | 077190 Voluntari, Ilfov  
 Tel.: +40-(0)31 421 85 68 | Email: info-RO@wago.com

Aveți întrebări despre produsele noastre?  
 Vă stăm la dispoziție pentru preluarea apelului la +40 (0) 31 421 85 68.



|                                      |                          |
|--------------------------------------|--------------------------|
| Height                               | 33,5 mm / 1.319 inch     |
| Height from the surface              | 27 mm / 1.063 inch       |
| Depth                                | 33,4 mm / 1.315 inch     |
| Solder pin length                    | 6,5 mm                   |
| Solder pin dimensions                | 1,2 x 1,6 mm             |
| Drilled hole diameter with tolerance | 2,2 <sup>(+0,1)</sup> mm |

**PCB contact**

|                                     |  |
|-------------------------------------|--|
| PCB contact                         | THT                                      |
| Solder pin arrangement              | over the entire terminal strip (in-line) |
| Number of solder pins per potential | 4  |

**Material Data**

|                             |  |
|-----------------------------|--|
| Color                       | gray                                   |
| Material group              | I                                      |
| Insulation material         | Polyamide 66 (PA 66)                   |
| Flammability class per UL94 | V0                                     |
| Clamping spring material    | Chrome nickel spring steel (CrNi)      |
| Contact material            | Electrolytic copper (E <sub>Cu</sub> ) |
| Contact plating             | tin-plated                             |
| Fire load                   | 1,103 MJ                               |
| Weight                      | 60,5 g                                 |

**Environmental Requirements**

|                         |                 |
|-------------------------|-----------------|
| Limit temperature range | -60 ... +105 °C |
|-------------------------|-----------------|

**Commercial data**

|                       |                     |
|-----------------------|---------------------|
| Product Group         | 4 (Printed Circuit) |
| Packaging type        | BOX                 |
| Country of origin     | PL                  |
| GTIN                  | 4044918303095       |
| Customs tariff number | 85369010000         |



**Aprobări / certificate****Country specific Approvals**

Nume

Supus modificărilor.

WAGO Kontakttechnik GmbH & Co. KG  
 /Representative Office Romania  
 Sos. Pipera-Tunari nr. 1/1  
 building 1, 2nd floor | 077190 Voluntari, Ilfov  
 Tel.: +40-(0)31 421 85 68 | Email: info-RO@wago.com

Aveți întrebări despre produsele noastre?  
 Vă stăm la dispoziție pentru preluarea apelului la +40 (0) 31 421 85 68.

| Emblemă  | Aprobare                        | Text de aprobare suplimentar | certificat  |
|--|---------------------------------|------------------------------|-------------|
|  | CCA<br>DEKRA Certification B.V. | EN 60947                     | 2160584.14  |
|  | CCA<br>DEKRA Certification B.V. | EN 60947                     | NTR NL-7094 |
|  | CSA<br>DEKRA Certification B.V. | C22.2 No. 158                | 1604421     |



## UL-Approvals

| Emblemă  | Aprobare                             | Text de aprobare suplimentar | Nume certificat |
|--|--------------------------------------|------------------------------|-----------------|
|  | UR<br>Underwriters Laboratories Inc. | UL 1059                      | E45172<br>sec6  |

## Counterpart

## Produse compatibile













## Marking accessories

|  |   |  |
|--|---|--|
|  | <b>Nr. articol: 2009-115</b><br>WMB-Inline; for Smart Printer; 1500 pieces on roll; stretchable 5 - 5.2 mm; plain; snap-on type; white          | <a href="http://www.wago.com/2009-115">www.wago.com/2009-115</a>                 |
|  | <b>Nr. articol: 2009-115/000-002</b><br>WMB-Inline; for Smart Printer; 1500 pieces on roll; stretchable 5 - 5.2 mm; plain; snap-on type; yellow | <a href="http://www.wago.com/2009-115/000-002">www.wago.com/2009-115/000-002</a> |
|  | <b>Nr. articol: 2009-115/000-006</b><br>WMB-Inline; for Smart Printer; 1500 pieces on roll; stretchable 5 - 5.2 mm; plain; snap-on type; blue   | <a href="http://www.wago.com/2009-115/000-006">www.wago.com/2009-115/000-006</a> |
|  | <b>Nr. articol: 2009-115/000-007</b><br>WMB-Inline; for Smart Printer; 1500 pieces on roll; stretchable 5 - 5.2 mm; plain; snap-on type; gray   | <a href="http://www.wago.com/2009-115/000-007">www.wago.com/2009-115/000-007</a> |

Supus modificărilor.

WAGO Kontakttechnik GmbH & Co. KG  
/Representative Office Romania  
Sos. Pipera-Tunari nr. 1/1  
building 1, 2nd floor | 077190 Voluntari, Ilfov  
Tel.: +40-(0)31 421 85 68 | Email: info-RO@wago.com

Aveți întrebări despre produsele noastre?  
Vă stăm la dispoziție pentru preluarea apelului la +40 (0) 31 421 85 68.

|  |  |  |
|--|--|--|
|   | <b>Nr. articol: 2009-115/000-012</b><br>WMB-Inline; for Smart Printer; 1500 pieces on roll; stretchable 5 - 5.2 mm; plain; snap-on type; orange      | <a href="http://www.wago.com/2009-115/000-012">www.wago.com/2009-115/000-012</a> |
|   | <b>Nr. articol: 2009-115/000-017</b><br>WMB-Inline; for Smart Printer; 1500 pieces on roll; stretchable 5 - 5.2 mm; plain; snap-on type; light green | <a href="http://www.wago.com/2009-115/000-017">www.wago.com/2009-115/000-017</a> |
|   | <b>Nr. articol: 2009-115/000-023</b><br>WMB-Inline; for Smart Printer; 1500 pieces on roll; stretchable 5 - 5.2 mm; plain; snap-on type; green       | <a href="http://www.wago.com/2009-115/000-023">www.wago.com/2009-115/000-023</a> |
|   | <b>Nr. articol: 2009-115/000-024</b><br>WMB-Inline; for Smart Printer; 1500 pieces on roll; stretchable 5 - 5.2 mm; plain; snap-on type; violet      | <a href="http://www.wago.com/2009-115/000-024">www.wago.com/2009-115/000-024</a> |
|    | <b>Nr. articol: 2009-145</b><br>Mini-WSB Inline; for Smart Printer; 1700 pieces on roll; stretchable 5 - 5.2 mm; plain; snap-on type; white          | <a href="http://www.wago.com/2009-145">www.wago.com/2009-145</a>                 |
|    | <b>Nr. articol: 2009-145/000-002</b><br>Mini-WSB Inline; for Smart Printer; 1700 pieces on roll; stretchable 5 - 5.2 mm; plain; snap-on type; yellow | <a href="http://www.wago.com/2009-145/000-002">www.wago.com/2009-145/000-002</a> |
|   | <b>Nr. articol: 2009-145/000-005</b><br>Mini-WSB Inline; for Smart Printer; 1700 pieces on roll; stretchable 5 - 5.2 mm; plain; snap-on type; red    | <a href="http://www.wago.com/2009-145/000-005">www.wago.com/2009-145/000-005</a> |
|  | <b>Nr. articol: 2009-145/000-006</b><br>Mini-WSB Inline; for Smart Printer; 1700 pieces on roll; stretchable 5 - 5.2 mm; plain; snap-on type; blue   | <a href="http://www.wago.com/2009-145/000-006">www.wago.com/2009-145/000-006</a> |
|  | <b>Nr. articol: 2009-145/000-007</b><br>Mini-WSB Inline; for Smart Printer; 1700 pieces on roll; stretchable 5 - 5.2 mm; plain; snap-on type; gray   | <a href="http://www.wago.com/2009-145/000-007">www.wago.com/2009-145/000-007</a> |
|  | <b>Nr. articol: 2009-145/000-012</b><br>Mini-WSB Inline; for Smart Printer; 1700 pieces on roll; stretchable 5 - 5.2 mm; plain; snap-on type; orange | <a href="http://www.wago.com/2009-145/000-012">www.wago.com/2009-145/000-012</a> |
|  | <b>Nr. articol: 2009-145/000-023</b><br>Mini-WSB Inline; for Smart Printer; 1700 pieces on roll; stretchable 5 - 5.2 mm; plain; snap-on type; green  | <a href="http://www.wago.com/2009-145/000-023">www.wago.com/2009-145/000-023</a> |
|  | <b>Nr. articol: 2009-145/000-024</b><br>Mini-WSB Inline; for Smart Printer; 1700 pieces on roll; stretchable 5 - 5.2 mm; plain; snap-on type; violet | <a href="http://www.wago.com/2009-145/000-024">www.wago.com/2009-145/000-024</a> |
|  | <b>Nr. articol: 248-501</b><br>Miniature WSB Quick marking system; plain; Marker width 5 mm; 10 strips with 10 markers per card                      | <a href="http://www.wago.com/248-501">www.wago.com/248-501</a>                   |

Supus modificărilor.

WAGO Kontakttechnik GmbH & Co. KG  
/Representative Office Romania  
Sos. Pipera-Tunari nr. 1/1  
building 1, 2nd floor | 077190 Voluntari, Ilfov  
Tel.: +40-(0)31 421 85 68 | Email: info-RO@wago.com

Aveți întrebări despre produsele noastre?  
Vă stăm la dispoziție pentru preluarea apelului la +40 (0) 31 421 85 68.



**Nr. articol: 248-501/000-002**

Mini-WSB marking card; as card; not stretchable; plain; snap-on type; yellow

[www.wago.com/248-501/000-002](http://www.wago.com/248-501/000-002)



**Nr. articol: 248-501/000-005**

Mini-WSB marking card; as card; not stretchable; plain; snap-on type; red

[www.wago.com/248-501/000-005](http://www.wago.com/248-501/000-005)



**Nr. articol: 248-501/000-006**

Mini-WSB marking card; as card; not stretchable; plain; snap-on type; blue

[www.wago.com/248-501/000-006](http://www.wago.com/248-501/000-006)



**Nr. articol: 248-501/000-007**

Mini-WSB marking card; as card; not stretchable; plain; snap-on type; gray

[www.wago.com/248-501/000-007](http://www.wago.com/248-501/000-007)



**Nr. articol: 248-501/000-012**

Mini-WSB marking card; as card; not stretchable; plain; snap-on type; orange

[www.wago.com/248-501/000-012](http://www.wago.com/248-501/000-012)



**Nr. articol: 248-501/000-017**

Mini-WSB marking card; as card; not stretchable; plain; snap-on type; light green

[www.wago.com/248-501/000-017](http://www.wago.com/248-501/000-017)



**Nr. articol: 248-501/000-023**

Mini-WSB marking card; as card; not stretchable; plain; snap-on type; green

[www.wago.com/248-501/000-023](http://www.wago.com/248-501/000-023)



**Nr. articol: 248-501/000-024**

Mini-WSB marking card; as card; not stretchable; plain; snap-on type; violet

[www.wago.com/248-501/000-024](http://www.wago.com/248-501/000-024)



**Nr. articol: 793-501**

WMB marking card; as card; not stretchable; plain; snap-on type; white

[www.wago.com/793-501](http://www.wago.com/793-501)



**Nr. articol: 793-5501**

WMB marking card; as card; for terminal block width 5 - 17.5 mm; stretchable 5 - 5.2 mm; plain; snap-on type; white

[www.wago.com/793-5501](http://www.wago.com/793-5501)



**Nr. articol: 793-5501/000-002**

WMB marking card; as card; for terminal block width 5 - 17.5 mm; stretchable 5 - 5.2 mm; plain; snap-on type; yellow

[www.wago.com/793-5501/000-002](http://www.wago.com/793-5501/000-002)



**Nr. articol: 793-5501/000-005**

WMB marking card; as card; for terminal block width 5 - 17.5 mm; stretchable 5 - 5.2 mm; plain; snap-on type; red

[www.wago.com/793-5501/000-005](http://www.wago.com/793-5501/000-005)



**Nr. articol: 793-5501/000-006**

WMB marking card; as card; for terminal block width 5 - 17.5 mm; stretchable 5 - 5.2 mm; plain; snap-on type; blue

[www.wago.com/793-5501/000-006](http://www.wago.com/793-5501/000-006)



**Nr. articol: 793-5501/000-007**

WMB marking card; as card; for terminal block width 5 - 17.5 mm; stretchable 5 - 5.2 mm; plain; snap-on type; gray

[www.wago.com/793-5501/000-007](http://www.wago.com/793-5501/000-007)

Supus modificărilor.

**Nr. articol:** 793-5501/000-012

WMB marking card; as card; for terminal block width 5 - 17.5 mm; stretchable 5 - 5.2 mm; plain; snap-on type; orange

[www.wago.com/793-5501/000-012](http://www.wago.com/793-5501/000-012)**Nr. articol:** 793-5501/000-017

WMB marking card; as card; for terminal block width 5 - 17.5 mm; stretchable 5 - 5.2 mm; plain; snap-on type; green

[www.wago.com/793-5501/000-017](http://www.wago.com/793-5501/000-017)**Nr. articol:** 793-5501/000-023

WMB marking card; as card; for terminal block width 5 - 17.5 mm; stretchable 5 - 5.2 mm; plain; snap-on type; light green

[www.wago.com/793-5501/000-023](http://www.wago.com/793-5501/000-023)**Nr. articol:** 793-5501/000-024

WMB marking card; as card; for terminal block width 5 - 17.5 mm; stretchable 5 - 5.2 mm; plain; snap-on type; violet

[www.wago.com/793-5501/000-024](http://www.wago.com/793-5501/000-024)**check****Nr. articol:** 210-136

Test plug; 2 mm Ø; with 500 mm cable; red

[www.wago.com/210-136](http://www.wago.com/210-136)**Nr. articol:** 210-137

Test plug; 2.3 mm Ø; with 500 mm cable; yellow

[www.wago.com/210-137](http://www.wago.com/210-137)**Jumper****Nr. articol:** 745-681

Comb-style jumper bar; from 1 to 3

[www.wago.com/745-681](http://www.wago.com/745-681)**Nr. articol:** 745-682

Comb-style jumper bar; 2-way

[www.wago.com/745-682](http://www.wago.com/745-682)**Nr. articol:** 745-683

Comb-style jumper bar; 3-way

[www.wago.com/745-683](http://www.wago.com/745-683)**Nr. articol:** 745-684

Comb-style jumper bar; 4-way

[www.wago.com/745-684](http://www.wago.com/745-684)**Nr. articol:** 745-685

Comb-style jumper bar; 5-way

















[www.wago.com/745-685](http://www.wago.com/745-685)**tools****Nr. articol:** 210-721

Operating tool; Blade: 5.5 x 0.8 mm; with a partially insulated shaft













[www.wago.com/210-721](http://www.wago.com/210-721)**ferrule****Nr. articol:** 216-101Ferrule; Sleeve for 0.5 mm<sup>2</sup> / AWG 22; uninsulated; electro-tin plated[www.wago.com/216-101](http://www.wago.com/216-101)**Nr. articol:** 216-102Ferrule; Sleeve for 0.75 mm<sup>2</sup> / AWG 20; uninsulated; electro-tin plated[www.wago.com/216-102](http://www.wago.com/216-102)**Nr. articol:** 216-103Ferrule; Sleeve for 1 mm<sup>2</sup> / AWG 18; uninsulated; electro-tin plated[www.wago.com/216-103](http://www.wago.com/216-103)

Supus modificărilor.



|  |   |  |
|--|---|--|
|    | <b>Nr. articol: 216-104</b><br>Ferrule; Sleeve for 1.5 mm <sup>2</sup> / AWG 16; uninsulated; electro-tin plated  | <a href="http://www.wago.com/216-104">www.wago.com/216-104</a> |
|    | <b>Nr. articol: 216-106</b><br>Ferrule; Sleeve for 2.5 mm <sup>2</sup> / AWG 14; uninsulated; electro-tin plated  | <a href="http://www.wago.com/216-106">www.wago.com/216-106</a> |
|    | <b>Nr. articol: 216-107</b><br>Ferrule; Sleeve for 4 mm <sup>2</sup> / AWG 12; uninsulated; electro-tin plated  | <a href="http://www.wago.com/216-107">www.wago.com/216-107</a> |
|    | <b>Nr. articol: 216-108</b><br>Ferrule; Sleeve for 6 mm <sup>2</sup> / AWG 10; uninsulated; electro-tin plated  | <a href="http://www.wago.com/216-108">www.wago.com/216-108</a> |
|    | <b>Nr. articol: 216-109</b><br>Ferrule; Sleeve for 10 mm <sup>2</sup> / AWG 8; uninsulated; electro-tin plated  | <a href="http://www.wago.com/216-109">www.wago.com/216-109</a> |
|    | <b>Nr. articol: 216-121</b><br>Ferrule; Sleeve for 0.5 mm <sup>2</sup> / AWG 22; uninsulated; electro-tin plated  | <a href="http://www.wago.com/216-121">www.wago.com/216-121</a> |
|    | <b>Nr. articol: 216-122</b><br>Ferrule; Sleeve for 0.75 mm <sup>2</sup> / AWG 20; uninsulated; electro-tin plated   | <a href="http://www.wago.com/216-122">www.wago.com/216-122</a> |
|    | <b>Nr. articol: 216-123</b><br>Ferrule; Sleeve for 1 mm <sup>2</sup> / AWG 18; uninsulated; electro-tin plated  | <a href="http://www.wago.com/216-123">www.wago.com/216-123</a> |
|    | <b>Nr. articol: 216-124</b><br>Ferrule; Sleeve for 1.5 mm <sup>2</sup> / AWG 16; uninsulated; electro-tin plated  | <a href="http://www.wago.com/216-124">www.wago.com/216-124</a> |
|   | <b>Nr. articol: 216-131</b><br>Ferrule; Sleeve for 0.25 mm <sup>2</sup> / AWG 24; uninsulated; electro-tin plated   | <a href="http://www.wago.com/216-131">www.wago.com/216-131</a> |
|  | <b>Nr. articol: 216-132</b><br>Ferrule; Sleeve for 0.34 mm <sup>2</sup> / AWG 24; uninsulated; electro-tin plated   | <a href="http://www.wago.com/216-132">www.wago.com/216-132</a> |
|  | <b>Nr. articol: 216-141</b><br>Ferrule; Sleeve for 0.5 mm <sup>2</sup> / 20 AWG; uninsulated; electro-tin plated; electrolytic copper; gastight crimped; acc. to DIN 46228, Part 1/08.92  | <a href="http://www.wago.com/216-141">www.wago.com/216-141</a> |
|  | <b>Nr. articol: 216-142</b><br>Ferrule; Sleeve for 0.75 mm <sup>2</sup> / 18 AWG; uninsulated; electro-tin plated; electrolytic copper; gastight crimped; acc. to DIN 46228, Part 1/08.92 | <a href="http://www.wago.com/216-142">www.wago.com/216-142</a> |
|  | <b>Nr. articol: 216-143</b><br>Ferrule; Sleeve for 1 mm <sup>2</sup> / AWG 18; uninsulated; electro-tin plated; electrolytic copper; gastight crimped; acc. to DIN 46228, Part 1/08.92    | <a href="http://www.wago.com/216-143">www.wago.com/216-143</a> |
|  | <b>Nr. articol: 216-144</b><br>Ferrule; Sleeve for 1.5 mm <sup>2</sup> / AWG 16; uninsulated; electro-tin plated; electrolytic copper; gastight crimped; acc. to DIN 46228, Part 1/08.92  | <a href="http://www.wago.com/216-144">www.wago.com/216-144</a> |
|  | <b>Nr. articol: 216-151</b><br>Ferrule; Sleeve for 0.25 mm <sup>2</sup> / AWG 24; uninsulated; electro-tin plated   | <a href="http://www.wago.com/216-151">www.wago.com/216-151</a> |
|  | <b>Nr. articol: 216-152</b><br>Ferrule; Sleeve for 0.34 mm <sup>2</sup> / AWG 24; uninsulated; electro-tin plated   | <a href="http://www.wago.com/216-152">www.wago.com/216-152</a> |
|  | <b>Nr. articol: 216-201</b><br>Ferrule; Sleeve for 0.5 mm <sup>2</sup> / 20 AWG; insulated; electro-tin plated; white   | <a href="http://www.wago.com/216-201">www.wago.com/216-201</a> |













Supus modificărilor.

|   |   |  |
|---|---|--|
|    |   |  |
|    | <b>Nr. articol: 216-202</b><br>Ferrule; Sleeve for 0.75 mm <sup>2</sup> / 18 AWG; insulated; electro-tin plated; gray   | <a href="http://www.wago.com/216-202">www.wago.com/216-202</a> |
|    | <b>Nr. articol: 216-203</b><br>Ferrule; Sleeve for 1 mm <sup>2</sup> / AWG 18; insulated; electro-tin plated; red   | <a href="http://www.wago.com/216-203">www.wago.com/216-203</a> |
|    | <b>Nr. articol: 216-204</b><br>Ferrule; Sleeve for 1.5 mm <sup>2</sup> / AWG 16; insulated; electro-tin plated; black   | <a href="http://www.wago.com/216-204">www.wago.com/216-204</a> |
|    | <b>Nr. articol: 216-205</b><br>Ferrule; Sleeve for 2.08 mm <sup>2</sup> / AWG 14; insulated; electro-tin plated; yellow   | <a href="http://www.wago.com/216-205">www.wago.com/216-205</a> |
|    | <b>Nr. articol: 216-206</b><br>Ferrule; Sleeve for 2.5 mm <sup>2</sup> / AWG 14; insulated; electro-tin plated; blue  | <a href="http://www.wago.com/216-206">www.wago.com/216-206</a> |
|    | <b>Nr. articol: 216-207</b><br>Ferrule; Sleeve for 4 mm <sup>2</sup> / AWG 12; insulated; electro-tin plated; gray  | <a href="http://www.wago.com/216-207">www.wago.com/216-207</a> |
|    | <b>Nr. articol: 216-208</b><br>Ferrule; Sleeve for 6 mm <sup>2</sup> / AWG 10; insulated; electro-tin plated; electrolytic copper; gastight crimped; acc. to DIN 46228, Part 4/09.90; yellow  | <a href="http://www.wago.com/216-208">www.wago.com/216-208</a> |
|    | <b>Nr. articol: 216-209</b><br>Ferrule; Sleeve for 10 mm <sup>2</sup> / AWG 8; insulated; electro-tin plated; red   | <a href="http://www.wago.com/216-209">www.wago.com/216-209</a> |
|   | <b>Nr. articol: 216-221</b><br>Ferrule; Sleeve for 0.5 mm <sup>2</sup> / 20 AWG; insulated; electro-tin plated; white   | <a href="http://www.wago.com/216-221">www.wago.com/216-221</a> |
|  | <b>Nr. articol: 216-222</b><br>Ferrule; Sleeve for 0.75 mm <sup>2</sup> / 18 AWG; insulated; electro-tin plated; gray   | <a href="http://www.wago.com/216-222">www.wago.com/216-222</a> |
|  | <b>Nr. articol: 216-223</b><br>Ferrule; Sleeve for 1 mm <sup>2</sup> / AWG 18; insulated; electro-tin plated; red   | <a href="http://www.wago.com/216-223">www.wago.com/216-223</a> |
|  | <b>Nr. articol: 216-224</b><br>Ferrule; Sleeve for 1.5 mm <sup>2</sup> / AWG 16; insulated; electro-tin plated; black   | <a href="http://www.wago.com/216-224">www.wago.com/216-224</a> |
|  | <b>Nr. articol: 216-241</b><br>Ferrule; Sleeve for 0.5 mm <sup>2</sup> / 20 AWG; insulated; electro-tin plated; electrolytic copper; gastight crimped; acc. to DIN 46228, Part 4/09.90; white | <a href="http://www.wago.com/216-241">www.wago.com/216-241</a> |
|  | <b>Nr. articol: 216-242</b><br>Ferrule; Sleeve for 0.75 mm <sup>2</sup> / 18 AWG; insulated; electro-tin plated; electrolytic copper; gastight crimped; acc. to DIN 46228, Part 4/09.90; gray | <a href="http://www.wago.com/216-242">www.wago.com/216-242</a> |
|  | <b>Nr. articol: 216-243</b><br>Ferrule; Sleeve for 1 mm <sup>2</sup> / AWG 18; insulated; electro-tin plated; electrolytic copper; gastight crimped; acc. to DIN 46228, Part 4/09.90; red     | <a href="http://www.wago.com/216-243">www.wago.com/216-243</a> |
|  | <b>Nr. articol: 216-244</b><br>Ferrule; Sleeve for 1.5 mm <sup>2</sup> / AWG 16; insulated; electro-tin plated; electrolytic copper; gastight crimped; acc. to DIN 46228, Part 4/09.90; black | <a href="http://www.wago.com/216-244">www.wago.com/216-244</a> |
|   | <b>Nr. articol: 216-246</b>   |  |

Supus modificărilor.

WAGO Kontakttechnik GmbH & Co. KG  
/Representative Office Romania  
Sos. Pipera-Tunari nr. 1/1  
building 1, 2nd floor | 077190 Voluntari, Ilfov  
Tel.: +40-(0)31 421 85 68 | Email: info-RO@wago.com

Aveți întrebări despre produsele noastre?  
Vă stăm la dispoziție pentru preluarea apelului la +40 (0) 31 421 85 68.

|   |  |  |
|---|--|--|
|    | Ferrule; Sleeve for 2.5 mm <sup>2</sup> / AWG 14; insulated; electro-tin plated; electrolytic copper; gastight crimped; acc. to DIN 46228, Part 4/09.90; blue  | <a href="http://www.wago.com/216-246">www.wago.com/216-246</a> |
|   | <b>Nr. articol: 216-262</b>  |  |
|    | Ferrule; Sleeve for 0.75 mm <sup>2</sup> / 18 AWG; insulated; electro-tin plated; electrolytic copper; gastight crimped; acc. to DIN 46228, Part 4/09.90; gray | <a href="http://www.wago.com/216-262">www.wago.com/216-262</a> |
|   | <b>Nr. articol: 216-263</b>  |  |
|    | Ferrule; Sleeve for 1 mm <sup>2</sup> / AWG 18; insulated; electro-tin plated; electrolytic copper; gastight crimped; acc. to DIN 46228, Part 4/09.90; red     | <a href="http://www.wago.com/216-263">www.wago.com/216-263</a> |
|   | <b>Nr. articol: 216-264</b>  |  |
|    | Ferrule; Sleeve for 1.5 mm <sup>2</sup> / AWG 16; insulated; electro-tin plated; electrolytic copper; gastight crimped; acc. to DIN 46228, Part 4/09.90; black | <a href="http://www.wago.com/216-264">www.wago.com/216-264</a> |
|   | <b>Nr. articol: 216-266</b>  |  |
|    | Ferrule; Sleeve for 2.5 mm <sup>2</sup> / AWG 14; insulated; electro-tin plated; electrolytic copper; gastight crimped; acc. to DIN 46228, Part 4/09.90; blue  | <a href="http://www.wago.com/216-266">www.wago.com/216-266</a> |
|   | <b>Nr. articol: 216-267</b>  |  |
|    | Ferrule; Sleeve for 4 mm <sup>2</sup> / AWG 12; insulated; electro-tin plated; electrolytic copper; gastight crimped; acc. to DIN 46228, Part 4/09.90; gray    | <a href="http://www.wago.com/216-267">www.wago.com/216-267</a> |
|   | <b>Nr. articol: 216-284</b>  |  |
|    | Ferrule; Sleeve for 1.5 mm <sup>2</sup> / AWG 16; insulated; electro-tin plated; electrolytic copper; gastight crimped; acc. to DIN 46228, Part 4/09.90; black | <a href="http://www.wago.com/216-284">www.wago.com/216-284</a> |
|   | <b>Nr. articol: 216-286</b>  |  |
|    | Ferrule; Sleeve for 2.5 mm <sup>2</sup> / AWG 14; insulated; electro-tin plated; electrolytic copper; gastight crimped; acc. to DIN 46228, Part 4/09.90; blue  | <a href="http://www.wago.com/216-286">www.wago.com/216-286</a> |
|   | <b>Nr. articol: 216-287</b>  |  |
|  | Ferrule; Sleeve for 4 mm <sup>2</sup> / AWG 12; insulated; electro-tin plated; electrolytic copper; gastight crimped; acc. to DIN 46228, Part 4/09.90; gray    | <a href="http://www.wago.com/216-287">www.wago.com/216-287</a> |
|   | <b>Nr. articol: 216-288</b>  |  |
|  | Ferrule; Sleeve for 6 mm <sup>2</sup> / AWG 10; insulated; electro-tin plated; electrolytic copper; gastight crimped; acc. to DIN 46228, Part 4/09.90; yellow  | <a href="http://www.wago.com/216-288">www.wago.com/216-288</a> |
|   | <b>Nr. articol: 216-289</b>  |  |
|  | Ferrule; Sleeve for 10 mm <sup>2</sup> / AWG 8; insulated; electro-tin plated; electrolytic copper; gastight crimped; acc. to DIN 46228, Part 4/09.90; red     | <a href="http://www.wago.com/216-289">www.wago.com/216-289</a> |
|   | <b>Nr. articol: 216-301</b>  |  |
|   | Ferrule; Sleeve for 0.25 mm <sup>2</sup> / AWG 24; insulated; electro-tin plated; yellow   | <a href="http://www.wago.com/216-301">www.wago.com/216-301</a> |
|   | <b>Nr. articol: 216-302</b>  |  |
|  | Ferrule; Sleeve for 0.34 mm <sup>2</sup> / 22 AWG; insulated; electro-tin plated; green  | <a href="http://www.wago.com/216-302">www.wago.com/216-302</a> |
|   | <b>Nr. articol: 216-321</b>  |  |
|   | Ferrule; Sleeve for 0.25 mm <sup>2</sup> / AWG 24; insulated; electro-tin plated; yellow   | <a href="http://www.wago.com/216-321">www.wago.com/216-321</a> |
|   | <b>Nr. articol: 216-322</b>  |  |
|  | Ferrule; Sleeve for 0.34 mm <sup>2</sup> / 22 AWG; insulated; electro-tin plated; green  | <a href="http://www.wago.com/216-322">www.wago.com/216-322</a> |

Supus modificărilor.

WAGO Kontakttechnik GmbH & Co. KG  
 /Representative Office Romania  
 Sos. Pipera-Tunari nr. 1/1  
 building 1, 2nd floor | 077190 Voluntari, Ilfov  
 Tel.: +40-(0)31 421 85 68 | Email: info-RO@wago.com

Aveți întrebări despre produsele noastre?  
 Vă stăm la dispoziție pentru preluarea apelului la +40 (0) 31 421 85 68.



## Descărcări

### Documentation

#### Additional Information

|                        |             |               |            |
|------------------------|-------------|---------------|------------|
| Technical explanations | Apr 3, 2019 | pdf<br>3,6 MB | Descărcare |
|------------------------|-------------|---------------|------------|

### CAD/CAE-Data

#### CAD data

|                              |     |            |
|------------------------------|-----|------------|
| 2D/3D Models 745-655/006-000 | URL | Descărcare |
|------------------------------|-----|------------|

#### CAE data

|                                   |     |            |
|-----------------------------------|-----|------------|
| EPLAN Data Portal 745-655/006-000 | URL | Descărcare |
|-----------------------------------|-----|------------|

#### PCB Design

|                                      |     |            |
|--------------------------------------|-----|------------|
| Symbol and Footprint 745-655/006-000 | URL | Descărcare |
|--------------------------------------|-----|------------|

CAX data for your PCB design, consisting of "schematic symbols and PCB footprints", allow easy integration of the WAGO component into your development environment.

#### Supported formats:

- Accel EDA 14 & 15
- Altium 6 to current version
- Cadence Allegro
- DesignSpark
- Eagle Libraries
- KiCad
- Mentor Graphics BoardStation
- Mentor Graphics Design Architect
- Mentor Graphics Design Expedition 99 and 2000
- OrCAD 9.X PCB and Capture
- PADS PowerPCB 3, 3.5, 4.X, and 5.X
- PADS PowerPCB and PowerLogic 3.0
- PCAD 2000, 2001, 2002, 2004, and 2006
- Pulsonix 8.5 or newer
- STL
- 3D STEP

Supus modificărilor.

WAGO Kontakttechnik GmbH & Co. KG  
/Representative Office Romania  
Sos. Pipera-Tunari nr. 1/1  
building 1, 2nd floor | 077190 Voluntari, Ilfov  
Tel.: +40-(0)31 421 85 68 | Email: info-RO@wago.com

Aveți întrebări despre produsele noastre?

Vă stăm la dispoziție pentru preluarea apelului la +40 (0) 31 421 85 68.

- TARGET 3001!
- View Logic ViewDraw
- Quadcept
- Zuken CadStar 3 and 4
- Zuken CR-5000 and CR-8000

PCB Component Libraries (EDA), PCB CAD Library Ultra Librarian

---

## Installation Notes

### Conductor termination

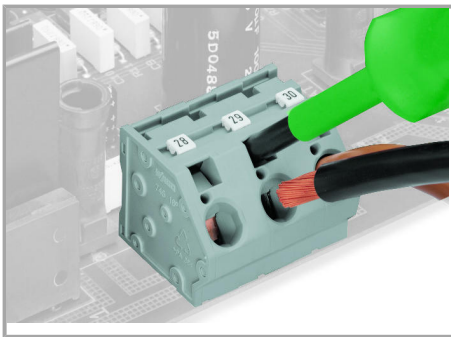

Inserting/removing a conductor via 5.5 mm screwdriver – 745 Series, 16 mm<sup>2</sup>.

### Marking

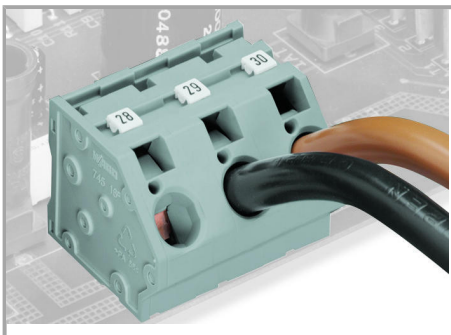

Marking via miniature WSB and WMB markers or factory direct marking – 745 Series.

### Testing

Supus modificărilor.

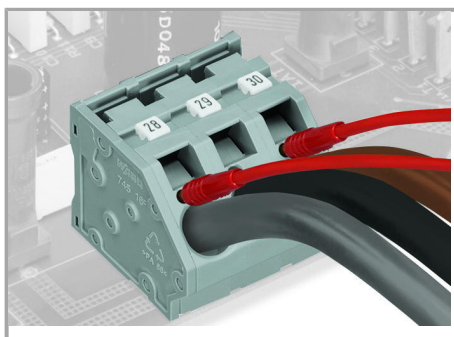

Testing with test plug – 745 Series.

### Commoning

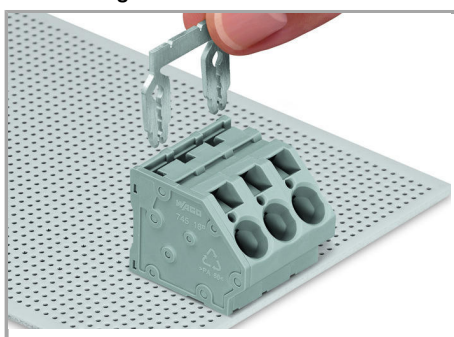

Inserting a comb-style jumper bar.

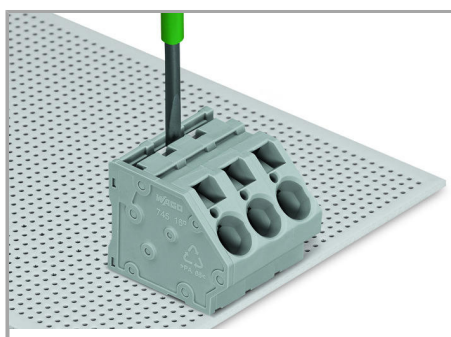

To insert a comb-style jumper bar, push it down using a screwdriver until it hits the backstop – 745 Series.

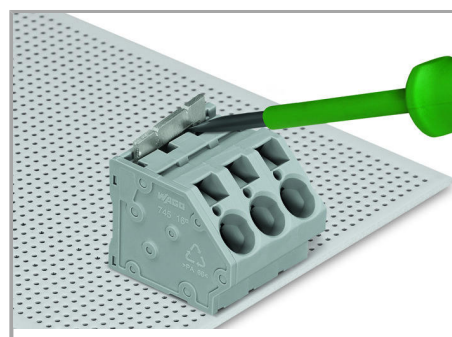

To remove the comb-style jumper bar, lift it up using a screwdriver – 745 Series.

Supus modificărilor.