

## Fișă tehnică | Număr articol: 280-524

Double-deck terminal block; Through/through terminal block; with additional jumper position on lower level; for DIN-rail 35 x 15 and 35 x 7.5; 2.5 mm<sup>2</sup>; CAGE CLAMP®; 2,50 mm<sup>2</sup>; blue/gray

[www.wago.com/280-524](http://www.wago.com/280-524)

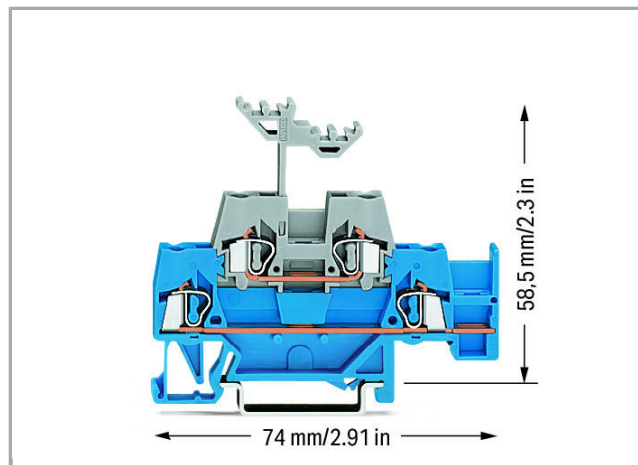
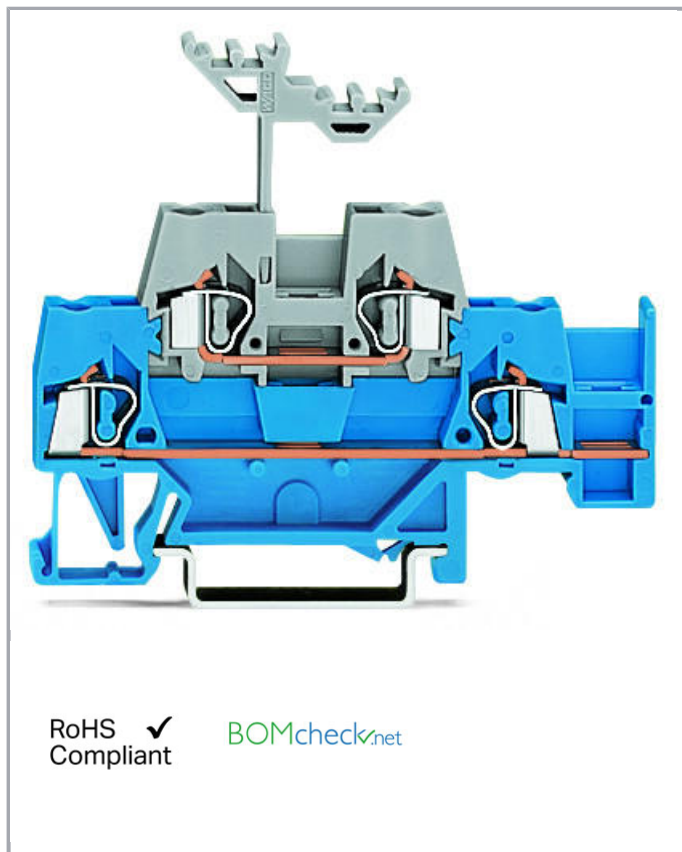

Supus modificărilor.

WAGO Kontakttechnik GmbH & Co. KG  
/Representative Office Romania  
Sos. Pipera-Tunari nr. 1/1  
building 1, 2nd floor | 077190 Voluntari, Ilfov  
Tel.: +40-(0)31 421 85 68 | Email: info-RO@wago.com

Aveți întrebări despre produsele noastre?  
Vă stăm la dispoziție pentru preluarea apelului la +40 (0) 31 421 85 68.

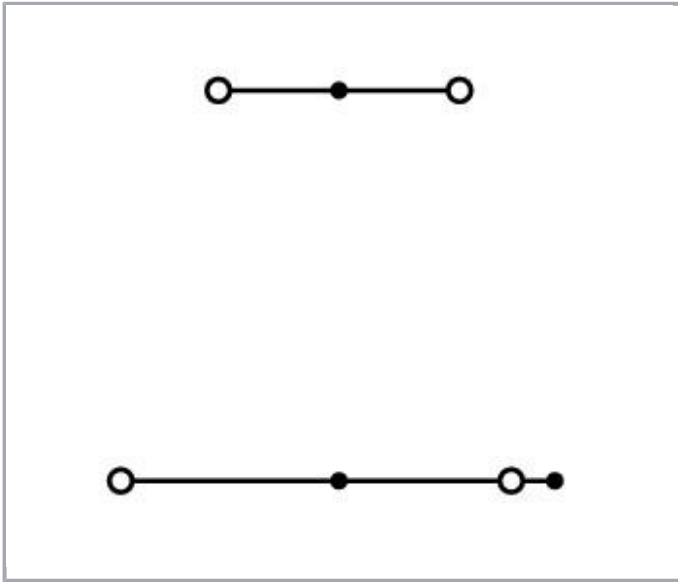

## Descriere articol

### Note:

#### Terminating Aluminum Conductors

WAGO spring clamp terminal blocks are suitable for solid aluminum conductors up to 4 mm<sup>2</sup>/12 AWG if WAGO "Alu-Plus" Contact Paste is used for termination.

"Alu-Plus" Contact Paste Advantages:

- Automatically destroys the oxide film during clamping.
- Prevents fresh oxidation at the clamping point.
- Prevents electrolytic corrosion between aluminum and copper conductors (in the same terminal block).
- Provides long-term protection against corrosion.

Using terminal blocks with CAGE CLAMP® Spring Pressure Connection Technology, **aluminum conductors must first be cleaned with a blade** and then immediately be inserted into the clamping units filled with "Alu-Plus" Contact Paste.

It is also possible to apply WAGO "Alu-Plus" **additionally** on the whole surface of the aluminum conductor before termination.

Please note that the nominal currents must be adapted to the reduced conductivity of the aluminum conductors:

2.5 mm<sup>2</sup> (14 AWG) = 16 A

4 mm<sup>2</sup> (12 AWG) = 22 A

## Date

### Electrical data

Supus modificărilor.

## Ratings per IEC/EN 60664-1

Ratings per	IEC/EN 60947-7-1
Nominal voltage (III/3)	500 V
Rated surge voltage (III/3)	6 kV
Rated current	20 A
Legend (ratings)	(III / 3) ≙ Overvoltage category III / Pollution degree 3

## Connection data

Connection technology	CAGE CLAMP®
Actuation type	Operating tool
Connectable conductor materials	Copper Aluminum
Solid conductor	0.08 ... 2.5 mm <sup>2</sup> / 28 ... 12 AWG
Fine-stranded conductor	0.08 ... 2.5 mm <sup>2</sup> / 28 ... 12 AWG
Strip length	8 ... 9 mm / 0.31 ... 0.35 inch
Total number of connection points	4
Total number of potentials	2
Number of levels	2
Wiring type	Front-entry wiring
Note (conductor cross-section)	12 AWG: THHN, THWN

## Geometrical Data

Width	5 mm / 0.197 inch
Height from upper-edge of DIN-rail	58.5 mm / 2.303 inch
Depth	74 mm / 2.913 inch

## Mechanical data

Design	horizontal
Mounting type	DIN-35 rail
Marking level	Center marking

## Material Data

Color	blue/gray
Insulation material	Polyamide 66 (PA 66)
Fire load	0,178 MJ
Weight	10,5 g

Supus modificărilor.

WAGO Kontakttechnik GmbH & Co. KG  
/Representative Office Romania  
Sos. Pipera-Tunari nr. 1/1  
building 1, 2nd floor | 077190 Voluntari, Ilfov  
Tel.: +40-(0)31 421 85 68 | Email: info-RO@wago.com



Aveți întrebări despre produsele noastre?  
Vă stăm la dispoziție pentru preluarea apelului la +40 (0) 31 421 85 68.

## Commercial data





Product Group	1 (Rail Mounted Terminal Blocks)
Packaging type	BOX
Country of origin	CN
GTIN	4050821293637
Customs tariff number	85369010000

## Aprobări / certificate

### Country specific Approvals

Emblemă	Aprobare	Text de aprobare suplimentar	Nume certificat
	<b>CCA</b> DEKRA Certification B.V.	EN 60947	2157201.01
	<b>CSA</b> DEKRA Certification B.V.	C22.2	1536071

### Ship Approvals

Emblemă	Aprobare	Text de aprobare suplimentar	Nume certificat
	<b>ABS</b> American Bureau of Shipping	EN 60947	20- HG1941090- PDA
	<b>BV</b> Bureau Veritas S.A.	EN 60947	07436/E0 BV
	<b>DNV GL</b> Det Norske Veritas, Germanischer Lloyd	-	TAE00001V2
	<b>LR</b> Lloyds Register	EN 60947	91/20112 (E9)

### UL-Approvals

Supus modificărilor.

WAGO Kontakttechnik GmbH & Co. KG  
/Representative Office Romania  
Sos. Pipera-Tunari nr. 1/1  
building 1, 2nd floor | 077190 Voluntari, Ilfov  
Tel.: +40-(0)31 421 85 68 | Email: info-RO@wago.com



Aveți întrebări despre produsele noastre?  
Vă stăm la dispoziție pentru preluarea apelului la +40 (0) 31 421 85 68.

Emblemă	Aprobare	Text de aprobare suplimentar	Nume certificat
	<b>UR</b> Underwriters Laboratories Inc.	UL 1059	20190731- E45172





## Counterpart

## Produse compatibile

### End plate

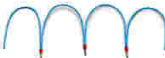
	<b>Nr. articol: 280-342</b> End and intermediate plate; 2.5 mm thick; gray	<a href="http://www.wago.com/280-342">www.wago.com/280-342</a>
	<b>Nr. articol: 280-343</b> End and intermediate plate; 2.5 mm thick; orange	<a href="http://www.wago.com/280-343">www.wago.com/280-343</a>



















### Jumper

	<b>Nr. articol: 210-103</b> Wire commoning chain; insulated; 50 connections; black	<a href="http://www.wago.com/210-103">www.wago.com/210-103</a>
	<b>Nr. articol: 210-123</b> Wire commoning chain; insulated; 50 connections	<a href="http://www.wago.com/210-123">www.wago.com/210-123</a>
	<b>Nr. articol: 249-123</b> Push-in type wire jumper; insulated; wire length 180 mm; Conductor cross section 0.75 mm <sup>2</sup>	<a href="http://www.wago.com/249-123">www.wago.com/249-123</a>
	<b>Nr. articol: 249-125</b> Push-in type wire jumper; insulated; wire length 60 mm; Conductor cross section 0.75 mm <sup>2</sup>	<a href="http://www.wago.com/249-125">www.wago.com/249-125</a>
	<b>Nr. articol: 249-126</b> Push-in type wire jumper; insulated; wire length 110 mm; Conductor cross section 0.75 mm <sup>2</sup>	<a href="http://www.wago.com/249-126">www.wago.com/249-126</a>
	<b>Nr. articol: 249-127</b> Push-in type wire jumper; insulated; wire length 250 mm; Conductor cross section 0.75 mm <sup>2</sup>	<a href="http://www.wago.com/249-127">www.wago.com/249-127</a>

Supus modificărilor.

WAGO Kontakttechnik GmbH & Co. KG  
/Representative Office Romania  
Sos. Pipera-Tunari nr. 1/1  
building 1, 2nd floor | 077190 Voluntari, Ilfov  
Tel.: +40-(0)31 421 85 68 | Email: info-RO@wago.com

Aveți întrebări despre produsele noastre?  
Vă stăm la dispoziție pentru preluarea apelului la +40 (0) 31 421 85 68.

	<b>Nr. articol: 280-402</b> Adjacent jumper; insulated; IN = IN terminal block; gray	<a href="http://www.wago.com/280-402">www.wago.com/280-402</a>
	<b>Nr. articol: 280-409</b> Alternate jumper; insulated; IN = IN terminal block; gray	<a href="http://www.wago.com/280-409">www.wago.com/280-409</a>
	<b>Nr. articol: 280-482</b> Comb-style jumper bar; insulated; 2-way; IN = IN terminal block; gray	<a href="http://www.wago.com/280-482">www.wago.com/280-482</a>
	<b>Nr. articol: 280-483</b> Comb-style jumper bar; insulated; 3-way; IN = IN terminal block; gray	<a href="http://www.wago.com/280-483">www.wago.com/280-483</a>
	<b>Nr. articol: 280-484</b> Comb-style jumper bar; insulated; 4-way; IN = IN terminal block; gray	<a href="http://www.wago.com/280-484">www.wago.com/280-484</a>
	<b>Nr. articol: 280-485</b> Comb-style jumper bar; insulated; 5-way; IN = IN terminal block; gray	<a href="http://www.wago.com/280-485">www.wago.com/280-485</a>
	<b>Nr. articol: 280-490</b> Comb-style jumper bar; insulated; 10-way; IN = IN terminal block; gray	<a href="http://www.wago.com/280-490">www.wago.com/280-490</a>
	<b>Nr. articol: 280-492</b> Alternate comb-style jumper bar; insulated; 2-way; IN = IN terminal block; gray	<a href="http://www.wago.com/280-492">www.wago.com/280-492</a>
	<b>Nr. articol: 281-421</b> Vertical jumper; insulated; Nominal current 24 A; gray	<a href="http://www.wago.com/281-421">www.wago.com/281-421</a>
	<b>Nr. articol: 709-110</b> Wire commoning chain; insulated; 4 connections; 3 x 110 mm; black	<a href="http://www.wago.com/709-110">www.wago.com/709-110</a>
	<b>Nr. articol: 709-111</b> Wire commoning chain; insulated; 3 connections; 2 x 120 mm; black	<a href="http://www.wago.com/709-111">www.wago.com/709-111</a>
	<b>Nr. articol: 709-112</b> Wire commoning chain; insulated; 3 connections; 2 x 170 mm; black	<a href="http://www.wago.com/709-112">www.wago.com/709-112</a>
	<b>Nr. articol: 780-452</b> Staggered jumper; insulated; from 1 to 2; Spacing: 5 mm; suitable for 2-conductor female plugs; gray	<a href="http://www.wago.com/780-452">www.wago.com/780-452</a>
	<b>Nr. articol: 780-453</b> Staggered jumper; insulated; from 1 to 3; Spacing: 5 mm; suitable for 2-conductor female plugs; gray	<a href="http://www.wago.com/780-453">www.wago.com/780-453</a>
	<b>Nr. articol: 780-454</b> Staggered jumper; insulated; from 1 to 4; Spacing: 5 mm; suitable for 2-conductor female plugs; gray	<a href="http://www.wago.com/780-454">www.wago.com/780-454</a>
	<b>Nr. articol: 780-455</b> Staggered jumper; insulated; from 1 to 5; Spacing: 5 mm; suitable for 2-conductor female plugs; gray	<a href="http://www.wago.com/780-455">www.wago.com/780-455</a>
	<b>Nr. articol: 780-456</b> Staggered jumper; insulated; from 1 to 6; Spacing: 5 mm; suitable for 2-conductor female plugs; gray	<a href="http://www.wago.com/780-456">www.wago.com/780-456</a>
	<b>Nr. articol: 780-457</b> Staggered jumper; insulated; from 1 to 7; Spacing: 5 mm; suitable for 2-conductor female plugs; gray	<a href="http://www.wago.com/780-457">www.wago.com/780-457</a>

Supus modificărilor.

WAGO Kontakttechnik GmbH & Co. KG  
/Representative Office Romania  
Sos. Pipera-Tunari nr. 1/1  
building 1, 2nd floor | 077190 Voluntari, Ilfov  
Tel.: +40-(0)31 421 85 68 | Email: info-RO@wago.com

Aveți întrebări despre produsele noastre?  
Vă stăm la dispoziție pentru preluarea apelului la +40 (0) 31 421 85 68.

**Nr. articol: 780-458**[www.wago.com/780-458](http://www.wago.com/780-458)

Staggered jumper; insulated; from 1 to 8; Spacing: 5 mm; suitable for 2-conductor female plugs; gray

## assembling

**Nr. articol: 209-106**[www.wago.com/209-106](http://www.wago.com/209-106)

Mounting carrier; for isolated mounting on DIN 35 rails; gray

**Nr. articol: 709-154**[www.wago.com/709-154](http://www.wago.com/709-154)

Cover; Type 2; suitable for cover carrier, type 2; 1 m long; transparent

## Female plug

**Nr. articol: 232-132/005-000**[www.wago.com/232-132/005-000](http://www.wago.com/232-132/005-000)

Female connector for rail-mount terminal blocks; 0.6 x 1 mm pins; straight; Pin spacing 5 mm; 2-pole; gray

**Nr. articol: 232-132/005-000/039-000**[www.wago.com/232-132/005-000/039-000](http://www.wago.com/232-132/005-000/039-000)

Female connector for rail-mount terminal blocks; 0.6 x 1 mm pins; straight; Locking lever; Pin spacing 5 mm; 2-pole; gray

**Nr. articol: 232-133/005-000**[www.wago.com/232-133/005-000](http://www.wago.com/232-133/005-000)

Female connector for rail-mount terminal blocks; 0.6 x 1 mm pins; straight; Pin spacing 5 mm; 3-pole; gray

**Nr. articol: 232-133/005-000/039-000**[www.wago.com/232-133/005-000/039-000](http://www.wago.com/232-133/005-000/039-000)

Female connector for rail-mount terminal blocks; 0.6 x 1 mm pins; straight; Locking lever; Pin spacing 5 mm; 3-pole; gray

**Nr. articol: 232-134/005-000**[www.wago.com/232-134/005-000](http://www.wago.com/232-134/005-000)

Female connector for rail-mount terminal blocks; 0.6 x 1 mm pins; straight; Pin spacing 5 mm; 4-pole; gray

**Nr. articol: 232-134/005-000/039-000**[www.wago.com/232-134/005-000/039-000](http://www.wago.com/232-134/005-000/039-000)

Female connector for rail-mount terminal blocks; 0.6 x 1 mm pins; straight; Locking lever; Pin spacing 5 mm; 4-pole; gray

**Nr. articol: 232-135/005-000**[www.wago.com/232-135/005-000](http://www.wago.com/232-135/005-000)

Female connector for rail-mount terminal blocks; 0.6 x 1 mm pins; straight; Pin spacing 5 mm; 5-pole; gray

**Nr. articol: 232-135/005-000/039-000**[www.wago.com/232-135/005-000/039-000](http://www.wago.com/232-135/005-000/039-000)

Female connector for rail-mount terminal blocks; 0.6 x 1 mm pins; straight; Locking lever; Pin spacing 5 mm; 5-pole; gray

**Nr. articol: 232-136/005-000**[www.wago.com/232-136/005-000](http://www.wago.com/232-136/005-000)













Female connector for rail-mount terminal blocks; 0.6 x 1 mm pins; straight; Pin spacing 5 mm; 6-pole; gray

**Nr. articol: 232-136/005-000/039-000**[www.wago.com/232-136/005-000/039-000](http://www.wago.com/232-136/005-000/039-000)

Female connector for rail-mount terminal blocks; 0.6 x 1 mm pins; straight; Locking lever; Pin spacing 5 mm; 6-pole; gray

**Nr. articol: 232-137/005-000**

Supus modificărilor.













	Female connector for rail-mount terminal blocks; 0.6 x 1 mm pins; straight; Pin spacing 5 mm; 7-pole; gray	<a href="http://www.wago.com/232-137/005-000">www.wago.com/232-137/005-000</a>
	<b>Nr. articol: 232-137/005-000/039-000</b> Female connector for rail-mount terminal blocks; 0.6 x 1 mm pins; straight; Locking lever; Pin spacing 5 mm; 7-pole; gray	<a href="http://www.wago.com/232-137/005-000/039-000">www.wago.com/232-137/005-000/039-000</a>
	<b>Nr. articol: 232-138/005-000</b> Female connector for rail-mount terminal blocks; 0.6 x 1 mm pins; straight; Pin spacing 5 mm; 8-pole; gray	<a href="http://www.wago.com/232-138/005-000">www.wago.com/232-138/005-000</a>
	<b>Nr. articol: 232-138/005-000/039-000</b> Female connector for rail-mount terminal blocks; 0.6 x 1 mm pins; straight; Locking lever; Pin spacing 5 mm; 8-pole; gray	<a href="http://www.wago.com/232-138/005-000/039-000">www.wago.com/232-138/005-000/039-000</a>
	<b>Nr. articol: 232-139/005-000</b> Female connector for rail-mount terminal blocks; 0.6 x 1 mm pins; straight; Pin spacing 5 mm; 9-pole; gray	<a href="http://www.wago.com/232-139/005-000">www.wago.com/232-139/005-000</a>
	<b>Nr. articol: 232-139/005-000/039-000</b> Female connector for rail-mount terminal blocks; 0.6 x 1 mm pins; straight; Locking lever; Pin spacing 5 mm; 9-pole; gray	<a href="http://www.wago.com/232-139/005-000/039-000">www.wago.com/232-139/005-000/039-000</a>
	<b>Nr. articol: 232-140/005-000</b> Female connector for rail-mount terminal blocks; 0.6 x 1 mm pins; straight; Pin spacing 5 mm; 10-pole; gray	<a href="http://www.wago.com/232-140/005-000">www.wago.com/232-140/005-000</a>
	<b>Nr. articol: 232-140/005-000/039-000</b> Female connector for rail-mount terminal blocks; 0.6 x 1 mm pins; straight; Locking lever; Pin spacing 5 mm; 10-pole; gray	<a href="http://www.wago.com/232-140/005-000/039-000">www.wago.com/232-140/005-000/039-000</a>
	<b>Nr. articol: 232-142/005-000</b> Female connector for rail-mount terminal blocks; 0.6 x 1 mm pins; straight; Pin spacing 5 mm; 12-pole; gray	<a href="http://www.wago.com/232-142/005-000">www.wago.com/232-142/005-000</a>
	<b>Nr. articol: 232-142/005-000/039-000</b> Female connector for rail-mount terminal blocks; 0.6 x 1 mm pins; straight; Locking lever; Pin spacing 5 mm; 12-pole; gray	<a href="http://www.wago.com/232-142/005-000/039-000">www.wago.com/232-142/005-000/039-000</a>
	<b>Nr. articol: 232-146/005-000</b> Female connector for rail-mount terminal blocks; 0.6 x 1 mm pins; straight; Pin spacing 5 mm; 16-pole; gray	<a href="http://www.wago.com/232-146/005-000">www.wago.com/232-146/005-000</a>
	<b>Nr. articol: 232-146/005-000/039-000</b> Female connector for rail-mount terminal blocks; 0.6 x 1 mm pins; straight; Locking lever; Pin spacing 5 mm; 16-pole; gray	<a href="http://www.wago.com/232-146/005-000/039-000">www.wago.com/232-146/005-000/039-000</a>
	<b>Nr. articol: 232-147/005-000/039-000</b> Female connector for rail-mount terminal blocks; 0.6 x 1 mm pins; straight; Locking lever; Pin spacing 5 mm; 17-pole; gray	<a href="http://www.wago.com/232-147/005-000/039-000">www.wago.com/232-147/005-000/039-000</a>
	<b>Nr. articol: 232-150/005-000</b>	

Supus modificărilor.













WAGO Kontakttechnik GmbH & Co. KG  
 /Representative Office Romania  
 Sos. Pipera-Tunari nr. 1/1  
 building 1, 2nd floor | 077190 Voluntari, Ilfov  
 Tel.: +40-(0)31 421 85 68 | Email: info-RO@wago.com

Aveți întrebări despre produsele noastre?  
 Vă stăm la dispoziție pentru preluarea apelului la +40 (0) 31 421 85 68.



	Female connector for rail-mount terminal blocks; 0.6 x 1 mm pins; straight; Pin spacing 5 mm; 20-pole; gray	<a href="http://www.wago.com/232-150/005-000">www.wago.com/232-150/005-000</a>
	<b>Nr. articol: 232-150/005-000/039-000</b> Female connector for rail-mount terminal blocks; 0.6 x 1 mm pins; straight; Locking lever; Pin spacing 5 mm; 20-pole; gray	<a href="http://www.wago.com/232-150/005-000/039-000">www.wago.com/232-150/005-000/039-000</a>
	<b>Nr. articol: 232-232/005-000</b> Female connector for rail-mount terminal blocks; 0.6 x 1 mm pins; angled; Pin spacing 5 mm; 2-pole; gray	<a href="http://www.wago.com/232-232/005-000">www.wago.com/232-232/005-000</a>
	<b>Nr. articol: 232-232/005-000/039-000</b> Female connector for rail-mount terminal blocks; 0.6 x 1 mm pins; angled; Locking lever; Pin spacing 5 mm; 2-pole; gray	<a href="http://www.wago.com/232-232/005-000/039-000">www.wago.com/232-232/005-000/039-000</a>
	<b>Nr. articol: 232-233/005-000</b> Female connector for rail-mount terminal blocks; 0.6 x 1 mm pins; angled; Pin spacing 5 mm; 3-pole; gray	<a href="http://www.wago.com/232-233/005-000">www.wago.com/232-233/005-000</a>
	<b>Nr. articol: 232-233/005-000/039-000</b> Female connector for rail-mount terminal blocks; 0.6 x 1 mm pins; angled; Locking lever; Pin spacing 5 mm; 3-pole; gray	<a href="http://www.wago.com/232-233/005-000/039-000">www.wago.com/232-233/005-000/039-000</a>
	<b>Nr. articol: 232-234/005-000</b> Female connector for rail-mount terminal blocks; 0.6 x 1 mm pins; angled; Pin spacing 5 mm; 4-pole; gray	<a href="http://www.wago.com/232-234/005-000">www.wago.com/232-234/005-000</a>
	<b>Nr. articol: 232-234/005-000/039-000</b> Female connector for rail-mount terminal blocks; 0.6 x 1 mm pins; angled; Locking lever; Pin spacing 5 mm; 4-pole; gray	<a href="http://www.wago.com/232-234/005-000/039-000">www.wago.com/232-234/005-000/039-000</a>
	<b>Nr. articol: 232-235/005-000</b> Female connector for rail-mount terminal blocks; 0.6 x 1 mm pins; angled; Pin spacing 5 mm; 5-pole; gray	<a href="http://www.wago.com/232-235/005-000">www.wago.com/232-235/005-000</a>
	<b>Nr. articol: 232-235/005-000/039-000</b> Female connector for rail-mount terminal blocks; 0.6 x 1 mm pins; angled; Locking lever; Pin spacing 5 mm; 5-pole; gray	<a href="http://www.wago.com/232-235/005-000/039-000">www.wago.com/232-235/005-000/039-000</a>
	<b>Nr. articol: 232-236/005-000</b> Female connector for rail-mount terminal blocks; 0.6 x 1 mm pins; angled; Pin spacing 5 mm; 6-pole; gray	<a href="http://www.wago.com/232-236/005-000">www.wago.com/232-236/005-000</a>
	<b>Nr. articol: 232-236/005-000/039-000</b> Female connector for rail-mount terminal blocks; 0.6 x 1 mm pins; angled; Locking lever; Pin spacing 5 mm; 6-pole; gray	<a href="http://www.wago.com/232-236/005-000/039-000">www.wago.com/232-236/005-000/039-000</a>
	<b>Nr. articol: 232-237/005-000</b> Female connector for rail-mount terminal blocks; 0.6 x 1 mm pins; angled; Pin spacing 5 mm; 7-pole; gray	<a href="http://www.wago.com/232-237/005-000">www.wago.com/232-237/005-000</a>
	<b>Nr. articol: 232-238/005-000</b>	

Supus modificărilor.

	Female connector for rail-mount terminal blocks; 0.6 x 1 mm pins; angled; Pin spacing 5 mm; 8-pole; gray	<a href="http://www.wago.com/232-238/005-000">www.wago.com/232-238/005-000</a>
	<b>Nr. articol: 232-239/005-000</b> Female connector for rail-mount terminal blocks; 0.6 x 1 mm pins; angled; Pin spacing 5 mm; 9-pole; gray	<a href="http://www.wago.com/232-239/005-000">www.wago.com/232-239/005-000</a>
	<b>Nr. articol: 232-240/005-000</b> Female connector for rail-mount terminal blocks; 0.6 x 1 mm pins; angled; Pin spacing 5 mm; 10-pole; gray	<a href="http://www.wago.com/232-240/005-000">www.wago.com/232-240/005-000</a>
	<b>Nr. articol: 232-240/005-000/039-000</b> Female connector for rail-mount terminal blocks; 0.6 x 1 mm pins; angled; Locking lever; Pin spacing 5 mm; 10-pole; gray	<a href="http://www.wago.com/232-240/005-000/039-000">www.wago.com/232-240/005-000/039-000</a>
	<b>Nr. articol: 232-242/005-000</b> Female connector for rail-mount terminal blocks; 0.6 x 1 mm pins; angled; Pin spacing 5 mm; 12-pole; gray	<a href="http://www.wago.com/232-242/005-000">www.wago.com/232-242/005-000</a>
	<b>Nr. articol: 232-242/005-000/039-000</b> Female connector for rail-mount terminal blocks; 0.6 x 1 mm pins; angled; Locking lever; Pin spacing 5 mm; 12-pole; gray	<a href="http://www.wago.com/232-242/005-000/039-000">www.wago.com/232-242/005-000/039-000</a>
	<b>Nr. articol: 232-246/005-000</b> Female connector for rail-mount terminal blocks; 0.6 x 1 mm pins; angled; Pin spacing 5 mm; 16-pole; gray	<a href="http://www.wago.com/232-246/005-000">www.wago.com/232-246/005-000</a>
	<b>Nr. articol: 232-246/005-000/039-000</b> Female connector for rail-mount terminal blocks; 0.6 x 1 mm pins; angled; Locking lever; Pin spacing 5 mm; 16-pole; gray	<a href="http://www.wago.com/232-246/005-000/039-000">www.wago.com/232-246/005-000/039-000</a>
	<b>Nr. articol: 232-250/005-000</b> Female connector for rail-mount terminal blocks; 0.6 x 1 mm pins; angled; Pin spacing 5 mm; 20-pole; gray	<a href="http://www.wago.com/232-250/005-000">www.wago.com/232-250/005-000</a>
	<b>Nr. articol: 232-250/005-000/039-000</b> Female connector for rail-mount terminal blocks; 0.6 x 1 mm pins; angled; Locking lever; Pin spacing 5 mm; 20-pole; gray	<a href="http://www.wago.com/232-250/005-000/039-000">www.wago.com/232-250/005-000/039-000</a>
	<b>Nr. articol: 232-732/005-000</b> THT female header; 0.6 x 1.0 mm solder pin; gray	<a href="http://www.wago.com/232-732/005-000">www.wago.com/232-732/005-000</a>
	<b>Nr. articol: 232-733/005-000</b> THT female header; 0.6 x 1.0 mm solder pin; gray	<a href="http://www.wago.com/232-733/005-000">www.wago.com/232-733/005-000</a>
	<b>Nr. articol: 232-734/005-000</b> THT female header; 0.6 x 1.0 mm solder pin; gray	<a href="http://www.wago.com/232-734/005-000">www.wago.com/232-734/005-000</a>

Supus modificărilor.



**Nr. articol: 232-734/005-000/039-000**  
THT female header; 0.6 x 1.0 mm solder pin; gray

[www.wago.com/232-734/005-000/039-000](http://www.wago.com/232-734/005-000/039-000)



**Nr. articol: 232-735/005-000**  
THT female header; 0.6 x 1.0 mm solder pin; gray

[www.wago.com/232-735/005-000](http://www.wago.com/232-735/005-000)



**Nr. articol: 232-735/005-000/039-000**  
THT female header; 0.6 x 1.0 mm solder pin; gray

[www.wago.com/232-735/005-000/039-000](http://www.wago.com/232-735/005-000/039-000)



**Nr. articol: 232-736/005-000**  
THT female header; 0.6 x 1.0 mm solder pin; gray

[www.wago.com/232-736/005-000](http://www.wago.com/232-736/005-000)



**Nr. articol: 232-736/005-000/039-000**  
THT female header; 0.6 x 1.0 mm solder pin; gray

[www.wago.com/232-736/005-000/039-000](http://www.wago.com/232-736/005-000/039-000)



**Nr. articol: 232-738/005-000**  
THT female header; 0.6 x 1.0 mm solder pin; gray

[www.wago.com/232-738/005-000](http://www.wago.com/232-738/005-000)



**Nr. articol: 232-740/005-000**  
THT female header; 0.6 x 1.0 mm solder pin; gray

[www.wago.com/232-740/005-000](http://www.wago.com/232-740/005-000)



**Nr. articol: 232-742/005-000**  
THT female header; 0.6 x 1.0 mm solder pin; gray

[www.wago.com/232-742/005-000](http://www.wago.com/232-742/005-000)



**Nr. articol: 232-832/005-000**  
THT female header; 0.6 x 1.0 mm solder pin; angled; Pin spacing 7.5 mm; 2-pole; gray

[www.wago.com/232-832/005-000](http://www.wago.com/232-832/005-000)



**Nr. articol: 232-833/005-000**  
THT female header; 0.6 x 1.0 mm solder pin; angled; Pin spacing 7.5 mm; 3-pole; gray

[www.wago.com/232-833/005-000](http://www.wago.com/232-833/005-000)



**Nr. articol: 232-834/005-000**  
THT female header; 0.6 x 1.0 mm solder pin; angled; Pin spacing 7.5 mm; 4-pole; gray

[www.wago.com/232-834/005-000](http://www.wago.com/232-834/005-000)



**Nr. articol: 232-836/005-000**  
THT female header; 0.6 x 1.0 mm solder pin; angled; Pin spacing 7.5 mm; 6-pole; gray













[www.wago.com/232-836/005-000](http://www.wago.com/232-836/005-000)















**Nr. articol: 232-836/005-000/039-000**  
THT female header; 0.6 x 1.0 mm solder pin; angled; Locking lever; Pin spacing 7.5 mm; 6-pole; gray

[www.wago.com/232-836/005-000/039-000](http://www.wago.com/232-836/005-000/039-000)

Supus modificărilor.

	<b>Nr. articol: 232-840/005-000</b> THT female header; 0.6 x 1.0 mm solder pin; angled; Pin spacing 7.5 mm; 10-pole; gray	<a href="http://www.wago.com/232-840/005-000">www.wago.com/232-840/005-000</a>
	<b>Nr. articol: 232-842/005-000</b> THT female header; 0.6 x 1.0 mm solder pin; angled; Pin spacing 7.5 mm; 12-pole; gray	<a href="http://www.wago.com/232-842/005-000">www.wago.com/232-842/005-000</a>
	<b>Nr. articol: 722-132/005-000</b> Female connector for rail-mount terminal blocks; 0.6 x 1 mm pins; straight; 100% protected against mismatching; Pin spacing 5 mm; 2-pole; light gray	<a href="http://www.wago.com/722-132/005-000">www.wago.com/722-132/005-000</a>
	<b>Nr. articol: 722-132/005-000/039-000</b> Female connector for rail-mount terminal blocks; 0.6 x 1 mm pins; straight; 100% protected against mismatching; Locking lever; Pin spacing 5 mm; 2-pole; light gray	<a href="http://www.wago.com/722-132/005-000/039-000">www.wago.com/722-132/005-000/039-000</a>
	<b>Nr. articol: 722-133/005-000</b> Female connector for rail-mount terminal blocks; 0.6 x 1 mm pins; straight; 100% protected against mismatching; Pin spacing 5 mm; 3-pole; light gray	<a href="http://www.wago.com/722-133/005-000">www.wago.com/722-133/005-000</a>
	<b>Nr. articol: 722-133/005-000/039-000</b> Female connector for rail-mount terminal blocks; 0.6 x 1 mm pins; straight; 100% protected against mismatching; Locking lever; Pin spacing 5 mm; 3-pole; light gray	<a href="http://www.wago.com/722-133/005-000/039-000">www.wago.com/722-133/005-000/039-000</a>
	<b>Nr. articol: 722-134/005-000</b> Female connector for rail-mount terminal blocks; 0.6 x 1 mm pins; straight; 100% protected against mismatching; Pin spacing 5 mm; 4-pole; light gray	<a href="http://www.wago.com/722-134/005-000">www.wago.com/722-134/005-000</a>
	<b>Nr. articol: 722-134/005-000/039-000</b> Female connector for rail-mount terminal blocks; 0.6 x 1 mm pins; straight; 100% protected against mismatching; Locking lever; Pin spacing 5 mm; 4-pole; light gray	<a href="http://www.wago.com/722-134/005-000/039-000">www.wago.com/722-134/005-000/039-000</a>
	<b>Nr. articol: 722-135/005-000</b> Female connector for rail-mount terminal blocks; 0.6 x 1 mm pins; straight; 100% protected against mismatching; Pin spacing 5 mm; 5-pole; light gray	<a href="http://www.wago.com/722-135/005-000">www.wago.com/722-135/005-000</a>
	<b>Nr. articol: 722-135/005-000/039-000</b> Female connector for rail-mount terminal blocks; 0.6 x 1 mm pins; straight; 100% protected against mismatching; Locking lever; Pin spacing 5 mm; 5-pole; light gray	<a href="http://www.wago.com/722-135/005-000/039-000">www.wago.com/722-135/005-000/039-000</a>
	<b>Nr. articol: 722-136/005-000</b> Female connector for rail-mount terminal blocks; 0.6 x 1 mm pins; straight; 100% protected against mismatching; Pin spacing 5 mm; 6-pole; light gray	<a href="http://www.wago.com/722-136/005-000">www.wago.com/722-136/005-000</a>
	<b>Nr. articol: 722-136/005-000/039-000</b> Female connector for rail-mount terminal blocks; 0.6 x 1 mm pins; straight; 100% protected against mismatching; Locking lever; Pin spacing 5 mm; 6-pole; light gray	<a href="http://www.wago.com/722-136/005-000/039-000">www.wago.com/722-136/005-000/039-000</a>
	<b>Nr. articol: 722-137/005-000</b> Female connector for rail-mount terminal blocks; 0.6 x 1 mm pins; straight; 100% protected against mismatching; Pin spacing 5 mm; 7-pole; light gray	<a href="http://www.wago.com/722-137/005-000">www.wago.com/722-137/005-000</a>
	<b>Nr. articol: 722-137/005-000/039-000</b>	

Supus modificărilor.

	Female connector for rail-mount terminal blocks; 0.6 x 1 mm pins; straight; 100% protected against mismatching; Locking lever; Pin spacing 5 mm; 7-pole; light gray	<a href="http://www.wago.com/722-137/005-000/039-000">www.wago.com/722-137/005-000/039-000</a>
	<b>Nr. articol: 722-138/005-000</b> Female connector for rail-mount terminal blocks; 0.6 x 1 mm pins; straight; 100% protected against mismatching; Pin spacing 5 mm; 8-pole; light gray	<a href="http://www.wago.com/722-138/005-000">www.wago.com/722-138/005-000</a>
	<b>Nr. articol: 722-138/005-000/039-000</b> Female connector for rail-mount terminal blocks; 0.6 x 1 mm pins; straight; 100% protected against mismatching; Locking lever; Pin spacing 5 mm; 8-pole; light gray	<a href="http://www.wago.com/722-138/005-000/039-000">www.wago.com/722-138/005-000/039-000</a>
	<b>Nr. articol: 722-139/005-000</b> Female connector for rail-mount terminal blocks; 0.6 x 1 mm pins; straight; 100% protected against mismatching; Pin spacing 5 mm; 9-pole; light gray	<a href="http://www.wago.com/722-139/005-000">www.wago.com/722-139/005-000</a>
	<b>Nr. articol: 722-139/005-000/039-000</b> Female connector for rail-mount terminal blocks; 0.6 x 1 mm pins; straight; 100% protected against mismatching; Locking lever; Pin spacing 5 mm; 9-pole; light gray	<a href="http://www.wago.com/722-139/005-000/039-000">www.wago.com/722-139/005-000/039-000</a>
	<b>Nr. articol: 722-140/005-000</b> Female connector for rail-mount terminal blocks; 0.6 x 1 mm pins; straight; 100% protected against mismatching; Pin spacing 5 mm; 10-pole; light gray	<a href="http://www.wago.com/722-140/005-000">www.wago.com/722-140/005-000</a>
	<b>Nr. articol: 722-140/005-000/039-000</b> Female connector for rail-mount terminal blocks; 0.6 x 1 mm pins; straight; 100% protected against mismatching; Locking lever; Pin spacing 5 mm; 10-pole; light gray	<a href="http://www.wago.com/722-140/005-000/039-000">www.wago.com/722-140/005-000/039-000</a>
	<b>Nr. articol: 722-141/005-000</b> Female connector for rail-mount terminal blocks; 0.6 x 1 mm pins; straight; 100% protected against mismatching; Pin spacing 5 mm; 11-pole; light gray	<a href="http://www.wago.com/722-141/005-000">www.wago.com/722-141/005-000</a>
	<b>Nr. articol: 722-142/005-000</b> Female connector for rail-mount terminal blocks; 0.6 x 1 mm pins; straight; 100% protected against mismatching; Pin spacing 5 mm; 12-pole; light gray	<a href="http://www.wago.com/722-142/005-000">www.wago.com/722-142/005-000</a>
	<b>Nr. articol: 722-142/005-007/039-000</b> Female connector for rail-mount terminal blocks; gray	<a href="http://www.wago.com/722-142/005-007/039-000">www.wago.com/722-142/005-007/039-000</a>
	<b>Nr. articol: 722-143/005-000</b> Female connector for rail-mount terminal blocks; 0.6 x 1 mm pins; straight; 100% protected against mismatching; Pin spacing 5 mm; 13-pole; light gray	<a href="http://www.wago.com/722-143/005-000">www.wago.com/722-143/005-000</a>
	<b>Nr. articol: 722-144/005-000</b> Female connector for rail-mount terminal blocks; 0.6 x 1 mm pins; straight; 100% protected against mismatching; Pin spacing 5 mm; 14-pole; light gray	<a href="http://www.wago.com/722-144/005-000">www.wago.com/722-144/005-000</a>
	<b>Nr. articol: 722-144/005-000/039-000</b> Female connector for rail-mount terminal blocks; 0.6 x 1 mm pins; straight; 100% protected against mismatching; Locking lever; Pin spacing 5 mm; 14-pole; light gray	<a href="http://www.wago.com/722-144/005-000/039-000">www.wago.com/722-144/005-000/039-000</a>

**Nr. articol: 722-145/005-000**

Supus modificărilor.

WAGO Kontakttechnik GmbH & Co. KG  
/Representative Office Romania  
Sos. Pipera-Tunari nr. 1/1  
building 1, 2nd floor | 077190 Voluntari, Ilfov  
Tel.: +40-(0)31 421 85 68 | Email: info-RO@wago.com

Aveți întrebări despre produsele noastre?  
Vă stăm la dispoziție pentru preluarea apelului la +40 (0) 31 421 85 68.



Female connector for rail-mount terminal blocks; 0.6 x 1 mm pins; straight; 100% protected against mismatching; Pin spacing 5 mm; 15-pole; light gray

[www.wago.com/722-145/005-000](http://www.wago.com/722-145/005-000)



**Nr. articol: 722-146/005-000**  
Female connector for rail-mount terminal blocks; 0.6 x 1 mm pins; straight; 100% protected against mismatching; Pin spacing 5 mm; 16-pole; light gray

[www.wago.com/722-146/005-000](http://www.wago.com/722-146/005-000)



**Nr. articol: 722-146/005-000/039-000**  
Female connector for rail-mount terminal blocks; 0.6 x 1 mm pins; straight; 100% protected against mismatching; Locking lever; Pin spacing 5 mm; 16-pole; light gray

[www.wago.com/722-146/005-000/039-000](http://www.wago.com/722-146/005-000/039-000)



**Nr. articol: 722-150/005-000**  
Female connector for rail-mount terminal blocks; 0.6 x 1 mm pins; straight; 100% protected against mismatching; Pin spacing 5 mm; 20-pole; light gray

[www.wago.com/722-150/005-000](http://www.wago.com/722-150/005-000)



**Nr. articol: 722-150/005-000/039-000**  
Female connector for rail-mount terminal blocks; 0.6 x 1 mm pins; straight; 100% protected against mismatching; Locking lever; Pin spacing 5 mm; 20-pole; light gray

[www.wago.com/722-150/005-000/039-000](http://www.wago.com/722-150/005-000/039-000)



**Nr. articol: 722-232/005-000**  
Female connector for rail-mount terminal blocks; 0.6 x 1 mm pins; angled; 100% protected against mismatching; Pin spacing 5 mm; 2-pole; light gray

[www.wago.com/722-232/005-000](http://www.wago.com/722-232/005-000)



**Nr. articol: 722-232/005-000/039-000**  
Female connector for rail-mount terminal blocks; 0.6 x 1 mm pins; angled; 100% protected against mismatching; Locking lever; Pin spacing 5 mm; 2-pole; light gray

[www.wago.com/722-232/005-000/039-000](http://www.wago.com/722-232/005-000/039-000)



**Nr. articol: 722-233/005-000**  
Female connector for rail-mount terminal blocks; 0.6 x 1 mm pins; angled; 100% protected against mismatching; Pin spacing 5 mm; 3-pole; light gray

[www.wago.com/722-233/005-000](http://www.wago.com/722-233/005-000)



**Nr. articol: 722-233/005-000/039-000**  
Female connector for rail-mount terminal blocks; 0.6 x 1 mm pins; angled; 100% protected against mismatching; Locking lever; Pin spacing 5 mm; 3-pole; light gray

[www.wago.com/722-233/005-000/039-000](http://www.wago.com/722-233/005-000/039-000)



**Nr. articol: 722-234/005-000**  
Female connector for rail-mount terminal blocks; 0.6 x 1 mm pins; angled; 100% protected against mismatching; Pin spacing 5 mm; 4-pole; light gray

[www.wago.com/722-234/005-000](http://www.wago.com/722-234/005-000)



**Nr. articol: 722-234/005-000/039-000**  
Female connector for rail-mount terminal blocks; 0.6 x 1 mm pins; angled; 100% protected against mismatching; Locking lever; Pin spacing 5 mm; 4-pole; light gray

[www.wago.com/722-234/005-000/039-000](http://www.wago.com/722-234/005-000/039-000)



**Nr. articol: 722-235/005-000**  
Female connector for rail-mount terminal blocks; 0.6 x 1 mm pins; angled; 100% protected against mismatching; Pin spacing 5 mm; 5-pole; light gray

[www.wago.com/722-235/005-000](http://www.wago.com/722-235/005-000)



**Nr. articol: 722-235/005-000/039-000**  
Female connector for rail-mount terminal blocks; 0.6 x 1 mm pins; angled; 100% protected against mismatching; Locking lever; Pin spacing 5 mm; 5-pole; light gray













[www.wago.com/722-235/005-000/039-000](http://www.wago.com/722-235/005-000/039-000)

**Nr. articol: 722-236/005-000**

Supus modificărilor.

WAGO Kontakttechnik GmbH & Co. KG  
/Representative Office Romania  
Sos. Pipera-Tunari nr. 1/1  
building 1, 2nd floor | 077190 Voluntari, Ilfov  
Tel.: +40-(0)31 421 85 68 | Email: info-RO@wago.com

Aveți întrebări despre produsele noastre?  
Vă stăm la dispoziție pentru preluarea apelului la +40 (0) 31 421 85 68.

	Female connector for rail-mount terminal blocks; 0.6 x 1 mm pins; angled; 100% protected against mismatching; Pin spacing 5 mm; 6-pole; light gray	<a href="http://www.wago.com/722-236/005-000">www.wago.com/722-236/005-000</a>
	<b>Nr. articol: 722-236/005-000/039-000</b> Female connector for rail-mount terminal blocks; 0.6 x 1 mm pins; angled; 100% protected against mismatching; Locking lever; Pin spacing 5 mm; 6-pole; light gray	<a href="http://www.wago.com/722-236/005-000/039-000">www.wago.com/722-236/005-000/039-000</a>
	<b>Nr. articol: 722-237/005-000</b> Female connector for rail-mount terminal blocks; 0.6 x 1 mm pins; angled; 100% protected against mismatching; Pin spacing 5 mm; 7-pole; light gray	<a href="http://www.wago.com/722-237/005-000">www.wago.com/722-237/005-000</a>
	<b>Nr. articol: 722-237/005-000/039-000</b> Female connector for rail-mount terminal blocks; 0.6 x 1 mm pins; angled; 100% protected against mismatching; Locking lever; Pin spacing 5 mm; 7-pole; light gray	<a href="http://www.wago.com/722-237/005-000/039-000">www.wago.com/722-237/005-000/039-000</a>
	<b>Nr. articol: 722-238/005-000</b> Female connector for rail-mount terminal blocks; 0.6 x 1 mm pins; angled; 100% protected against mismatching; Pin spacing 5 mm; 8-pole; light gray	<a href="http://www.wago.com/722-238/005-000">www.wago.com/722-238/005-000</a>
	<b>Nr. articol: 722-239/005-000</b> Female connector for rail-mount terminal blocks; 0.6 x 1 mm pins; angled; 100% protected against mismatching; Pin spacing 5 mm; 9-pole; light gray	<a href="http://www.wago.com/722-239/005-000">www.wago.com/722-239/005-000</a>
	<b>Nr. articol: 722-239/005-000/039-000</b> Female connector for rail-mount terminal blocks; 0.6 x 1 mm pins; angled; 100% protected against mismatching; Locking lever; Pin spacing 5 mm; 9-pole; light gray	<a href="http://www.wago.com/722-239/005-000/039-000">www.wago.com/722-239/005-000/039-000</a>
	<b>Nr. articol: 722-240/005-000</b> Female connector for rail-mount terminal blocks; 0.6 x 1 mm pins; angled; 100% protected against mismatching; Pin spacing 5 mm; 10-pole; light gray	<a href="http://www.wago.com/722-240/005-000">www.wago.com/722-240/005-000</a>
	<b>Nr. articol: 722-240/005-000/039-000</b> Female connector for rail-mount terminal blocks; 0.6 x 1 mm pins; angled; 100% protected against mismatching; Locking lever; Pin spacing 5 mm; 10-pole; light gray	<a href="http://www.wago.com/722-240/005-000/039-000">www.wago.com/722-240/005-000/039-000</a>
	<b>Nr. articol: 722-241/005-000</b> Female connector for rail-mount terminal blocks; 0.6 x 1 mm pins; angled; 100% protected against mismatching; Pin spacing 5 mm; 11-pole; light gray	<a href="http://www.wago.com/722-241/005-000">www.wago.com/722-241/005-000</a>
	<b>Nr. articol: 722-242/005-000</b> Female connector for rail-mount terminal blocks; 0.6 x 1 mm pins; angled; 100% protected against mismatching; Pin spacing 5 mm; 12-pole; light gray	<a href="http://www.wago.com/722-242/005-000">www.wago.com/722-242/005-000</a>
	<b>Nr. articol: 722-242/005-000/039-000</b> Female connector for rail-mount terminal blocks; 0.6 x 1 mm pins; angled; 100% protected against mismatching; Locking lever; Pin spacing 5 mm; 12-pole; light gray	<a href="http://www.wago.com/722-242/005-000/039-000">www.wago.com/722-242/005-000/039-000</a>
	<b>Nr. articol: 722-243/005-000</b> Female connector for rail-mount terminal blocks; 0.6 x 1 mm pins; angled; 100% protected against mismatching; Pin spacing 5 mm; 13-pole; light gray	<a href="http://www.wago.com/722-243/005-000">www.wago.com/722-243/005-000</a>

**Nr. articol: 722-244/005-000**

Supus modificărilor.

WAGO Kontakttechnik GmbH & Co. KG  
/Representative Office Romania  
Sos. Pipera-Tunari nr. 1/1  
building 1, 2nd floor | 077190 Voluntari, Ilfov  
Tel.: +40-(0)31 421 85 68 | Email: info-RO@wago.com

Aveți întrebări despre produsele noastre?  
Vă stăm la dispoziție pentru preluarea apelului la +40 (0) 31 421 85 68.



Female connector for rail-mount terminal blocks; 0.6 x 1 mm pins; angled; 100% protected against mismatching; Pin spacing 5 mm; 14-pole; light gray

[www.wago.com/722-244/005-000](http://www.wago.com/722-244/005-000)



**Nr. articol: 722-244/005-000/039-000**

Female connector for rail-mount terminal blocks; 0.6 x 1 mm pins; angled; 100% protected against mismatching; Locking lever; Pin spacing 5 mm; 14-pole; light gray

[www.wago.com/722-244/005-000/039-000](http://www.wago.com/722-244/005-000/039-000)



**Nr. articol: 722-246/005-000**

Female connector for rail-mount terminal blocks; 0.6 x 1 mm pins; angled; 100% protected against mismatching; Pin spacing 5 mm; 16-pole; light gray

[www.wago.com/722-246/005-000](http://www.wago.com/722-246/005-000)



**Nr. articol: 722-246/005-000/039-000**

Female connector for rail-mount terminal blocks; 0.6 x 1 mm pins; angled; 100% protected against mismatching; Locking lever; Pin spacing 5 mm; 16-pole; light gray

[www.wago.com/722-246/005-000/039-000](http://www.wago.com/722-246/005-000/039-000)



**Nr. articol: 722-250/005-000**

Female connector for rail-mount terminal blocks; 0.6 x 1 mm pins; angled; 100% protected against mismatching; Pin spacing 5 mm; 20-pole; light gray

[www.wago.com/722-250/005-000](http://www.wago.com/722-250/005-000)

#### ferrule



**Nr. articol: 216-101**

Ferrule; Sleeve for 0.5 mm<sup>2</sup> / AWG 22; uninsulated; electro-tin plated

[www.wago.com/216-101](http://www.wago.com/216-101)



**Nr. articol: 216-102**

Ferrule; Sleeve for 0.75 mm<sup>2</sup> / AWG 20; uninsulated; electro-tin plated

[www.wago.com/216-102](http://www.wago.com/216-102)



**Nr. articol: 216-103**

Ferrule; Sleeve for 1 mm<sup>2</sup> / AWG 18; uninsulated; electro-tin plated

[www.wago.com/216-103](http://www.wago.com/216-103)



**Nr. articol: 216-104**

Ferrule; Sleeve for 1.5 mm<sup>2</sup> / AWG 16; uninsulated; electro-tin plated

[www.wago.com/216-104](http://www.wago.com/216-104)



**Nr. articol: 216-201**

Ferrule; Sleeve for 0.5 mm<sup>2</sup> / 20 AWG; insulated; electro-tin plated; white

[www.wago.com/216-201](http://www.wago.com/216-201)



**Nr. articol: 216-202**

Ferrule; Sleeve for 0.75 mm<sup>2</sup> / 18 AWG; insulated; electro-tin plated; gray

[www.wago.com/216-202](http://www.wago.com/216-202)



**Nr. articol: 216-203**

Ferrule; Sleeve for 1 mm<sup>2</sup> / AWG 18; insulated; electro-tin plated; red

[www.wago.com/216-203](http://www.wago.com/216-203)



**Nr. articol: 216-204**

Ferrule; Sleeve for 1.5 mm<sup>2</sup> / AWG 16; insulated; electro-tin plated; black

[www.wago.com/216-204](http://www.wago.com/216-204)

**Nr. articol: 216-301**

Ferrule; Sleeve for 0.25 mm<sup>2</sup> / AWG 24; insulated; electro-tin plated; yellow

[www.wago.com/216-301](http://www.wago.com/216-301)



**Nr. articol: 216-302**

Ferrule; Sleeve for 0.34 mm<sup>2</sup> / 22 AWG; insulated; electro-tin plated; green















[www.wago.com/216-302](http://www.wago.com/216-302)

#### Insulation stop

**Nr. articol: 280-470**

Supus modificărilor.



	Insulation stop; 0.08 - 0.2 mm <sup>2</sup> "s" (0.14 mm <sup>2</sup> "f-st"); 5 pieces/strip; white	<a href="http://www.wago.com/280-470">www.wago.com/280-470</a>
	<b>Nr. articol: 280-471</b> Insulation stop; 0.25 - 0.5 mm <sup>2</sup> ; 5 pieces/strip; light gray	<a href="http://www.wago.com/280-471">www.wago.com/280-471</a>
	<b>Nr. articol: 280-472</b> Insulation stop; 0.75 - 1 mm <sup>2</sup> ; 5 pieces/strip	<a href="http://www.wago.com/280-472">www.wago.com/280-472</a>
<b>Marking accessories</b>		
	<b>Nr. articol: 2009-115</b> WMB-Inline; for Smart Printer; 1500 pieces on roll; stretchable 5 - 5.2 mm; plain; snap-on type; white	<a href="http://www.wago.com/2009-115">www.wago.com/2009-115</a>
	<b>Nr. articol: 2009-115/000-002</b> WMB-Inline; for Smart Printer; 1500 pieces on roll; stretchable 5 - 5.2 mm; plain; snap-on type; yellow	<a href="http://www.wago.com/2009-115/000-002">www.wago.com/2009-115/000-002</a>
	<b>Nr. articol: 2009-115/000-006</b> WMB-Inline; for Smart Printer; 1500 pieces on roll; stretchable 5 - 5.2 mm; plain; snap-on type; blue	<a href="http://www.wago.com/2009-115/000-006">www.wago.com/2009-115/000-006</a>
	<b>Nr. articol: 2009-115/000-007</b> WMB-Inline; for Smart Printer; 1500 pieces on roll; stretchable 5 - 5.2 mm; plain; snap-on type; gray	<a href="http://www.wago.com/2009-115/000-007">www.wago.com/2009-115/000-007</a>
	<b>Nr. articol: 2009-115/000-012</b> WMB-Inline; for Smart Printer; 1500 pieces on roll; stretchable 5 - 5.2 mm; plain; snap-on type; orange	<a href="http://www.wago.com/2009-115/000-012">www.wago.com/2009-115/000-012</a>
	<b>Nr. articol: 2009-115/000-017</b> WMB-Inline; for Smart Printer; 1500 pieces on roll; stretchable 5 - 5.2 mm; plain; snap-on type; light green	<a href="http://www.wago.com/2009-115/000-017">www.wago.com/2009-115/000-017</a>
	<b>Nr. articol: 2009-115/000-023</b> WMB-Inline; for Smart Printer; 1500 pieces on roll; stretchable 5 - 5.2 mm; plain; snap-on type; green	<a href="http://www.wago.com/2009-115/000-023">www.wago.com/2009-115/000-023</a>
	<b>Nr. articol: 2009-115/000-024</b> WMB-Inline; for Smart Printer; 1500 pieces on roll; stretchable 5 - 5.2 mm; plain; snap-on type; violet	<a href="http://www.wago.com/2009-115/000-024">www.wago.com/2009-115/000-024</a>
	<b>Nr. articol: 793-501</b> WMB marking card; as card; not stretchable; plain; snap-on type; white	<a href="http://www.wago.com/793-501">www.wago.com/793-501</a>
	<b>Nr. articol: 793-501/000-002</b> WMB marking card; as card; not stretchable; plain; snap-on type; yellow	<a href="http://www.wago.com/793-501/000-002">www.wago.com/793-501/000-002</a>
	<b>Nr. articol: 793-501/000-005</b> WMB marking card; as card; not stretchable; plain; snap-on type; red	<a href="http://www.wago.com/793-501/000-005">www.wago.com/793-501/000-005</a>

Supus modificărilor.

**Nr. articol: 793-501/000-006**

WMB marking card; as card; not stretchable; plain; snap-on type; blue

[www.wago.com/793-501/000-006](http://www.wago.com/793-501/000-006)**Nr. articol: 793-501/000-007**

WMB marking card; as card; not stretchable; plain; snap-on type; gray

[www.wago.com/793-501/000-007](http://www.wago.com/793-501/000-007)**Nr. articol: 793-501/000-012**

WMB marking card; as card; not stretchable; plain; snap-on type; orange

[www.wago.com/793-501/000-012](http://www.wago.com/793-501/000-012)**Nr. articol: 793-501/000-017**

WMB marking card; as card; not stretchable; plain; snap-on type; light green

[www.wago.com/793-501/000-017](http://www.wago.com/793-501/000-017)**Nr. articol: 793-501/000-023**

WMB marking card; as card; not stretchable; plain; snap-on type; green

[www.wago.com/793-501/000-023](http://www.wago.com/793-501/000-023)**Nr. articol: 793-501/000-024**

WMB marking card; as card; not stretchable; plain; snap-on type; violet

[www.wago.com/793-501/000-024](http://www.wago.com/793-501/000-024)**Nr. articol: 793-5501**

WMB marking card; as card; for terminal block width 5 - 17.5 mm; stretchable 5 - 5.2 mm; plain; snap-on type; white

[www.wago.com/793-5501](http://www.wago.com/793-5501)**Nr. articol: 793-5501/000-002**

WMB marking card; as card; for terminal block width 5 - 17.5 mm; stretchable 5 - 5.2 mm; plain; snap-on type; yellow

[www.wago.com/793-5501/000-002](http://www.wago.com/793-5501/000-002)**Nr. articol: 793-5501/000-005**

WMB marking card; as card; for terminal block width 5 - 17.5 mm; stretchable 5 - 5.2 mm; plain; snap-on type; red

[www.wago.com/793-5501/000-005](http://www.wago.com/793-5501/000-005)**Nr. articol: 793-5501/000-006**

WMB marking card; as card; for terminal block width 5 - 17.5 mm; stretchable 5 - 5.2 mm; plain; snap-on type; blue

[www.wago.com/793-5501/000-006](http://www.wago.com/793-5501/000-006)**Nr. articol: 793-5501/000-007**

WMB marking card; as card; for terminal block width 5 - 17.5 mm; stretchable 5 - 5.2 mm; plain; snap-on type; gray

[www.wago.com/793-5501/000-007](http://www.wago.com/793-5501/000-007)**Nr. articol: 793-5501/000-012**

WMB marking card; as card; for terminal block width 5 - 17.5 mm; stretchable 5 - 5.2 mm; plain; snap-on type; orange

[www.wago.com/793-5501/000-012](http://www.wago.com/793-5501/000-012)**Nr. articol: 793-5501/000-017**

WMB marking card; as card; for terminal block width 5 - 17.5 mm; stretchable 5 - 5.2 mm; plain; snap-on type; green

[www.wago.com/793-5501/000-017](http://www.wago.com/793-5501/000-017)**Nr. articol: 793-5501/000-023**

Supus modificărilor.



WMB marking card; as card; for terminal block width 5 - 17.5 mm; stretchable 5 - 5.2 mm; plain; snap-on type; light green

[www.wago.com/793-5501/000-023](http://www.wago.com/793-5501/000-023)



**Nr. articol: 793-5501/000-024**

WMB marking card; as card; for terminal block width 5 - 17.5 mm; stretchable 5 - 5.2 mm; plain; snap-on type; violet

[www.wago.com/793-5501/000-024](http://www.wago.com/793-5501/000-024)

#### Protective Warning Marker



**Nr. articol: 280-415**

Protective warning marker; with high-voltage symbol, black; for 5 terminal blocks; yellow

[www.wago.com/280-415](http://www.wago.com/280-415)

#### Carrier rail



**Nr. articol: 210-112**

Steel carrier rail; 35 x 7.5 mm; 1 mm thick; 2 m long; slotted; according to EN 60715; "Hole width 25 mm

[www.wago.com/210-112](http://www.wago.com/210-112)

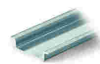

**Nr. articol: 210-113**

Steel carrier rail; 35 x 7.5 mm; 1 mm thick; 2 m long; unslotted; according to EN 60715

[www.wago.com/210-113](http://www.wago.com/210-113)



**Nr. articol: 210-114**

Steel carrier rail; 35 x 15 mm; 1.5 mm thick; 2 m long; unslotted; similar to EN 60715

[www.wago.com/210-114](http://www.wago.com/210-114)



**Nr. articol: 210-115**

Steel carrier rail; 35 x 7.5 mm; 1 mm thick; 2 m long; slotted; according to EN 60715; "Hole width 18 mm

[www.wago.com/210-115](http://www.wago.com/210-115)



**Nr. articol: 210-118**

Steel carrier rail; 35 x 15 mm; 2.3 mm thick; 2 m long; unslotted; according to EN 60715

[www.wago.com/210-118](http://www.wago.com/210-118)

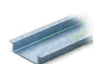

**Nr. articol: 210-196**

Aluminum carrier rail; 35 x 8.2 mm; 1.6 mm thick; 2 m long; unslotted; similar to EN 60715; silver-colored

[www.wago.com/210-196](http://www.wago.com/210-196)



**Nr. articol: 210-197**

Steel carrier rail; 35 x 15 mm; 1.5 mm thick; 2 m long; slotted; similar to EN 60715

[www.wago.com/210-197](http://www.wago.com/210-197)



**Nr. articol: 210-198**

Copper carrier rail; 35 x 15 mm; 2.3 mm thick; 2 m long; unslotted; according to EN 60715; copper-colored

[www.wago.com/210-198](http://www.wago.com/210-198)



**Nr. articol: 210-504**

Steel carrier rail; 35 x 7.5 mm; 1 mm thick; 2 m long; slotted; galvanized; according to EN 60715

[www.wago.com/210-504](http://www.wago.com/210-504)

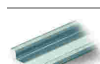

**Nr. articol: 210-505**

Steel carrier rail; 35 x 7.5 mm; 1 mm thick; 2 m long; unslotted; galvanized; according to EN 60715

[www.wago.com/210-505](http://www.wago.com/210-505)



**Nr. articol: 210-506**

Steel carrier rail; 35 x 15 mm; 1.5 mm thick; 2 m long; unslotted; galvanized; similar to EN 60715

[www.wago.com/210-506](http://www.wago.com/210-506)



**Nr. articol: 210-508**

Steel carrier rail; 35 x 15 mm; 1.5 mm thick; 2 m long; slotted; galvanized; similar to EN 60715

[www.wago.com/210-508](http://www.wago.com/210-508)

#### tools

Supus modificărilor.

WAGO Kontakttechnik GmbH & Co. KG  
/Representative Office Romania  
Sos. Pipera-Tunari nr. 1/1  
building 1, 2nd floor | 077190 Voluntari, Ilfov  
Tel.: +40-(0)31 421 85 68 | Email: info-RO@wago.com

Aveți întrebări despre produsele noastre?  
Vă stăm la dispoziție pentru preluarea apelului la +40 (0) 31 421 85 68.

**Nr. articol: 210-657**

Operating tool; Blade: 3.5 x 0.5 mm; with a partially insulated shaft; short

[www.wago.com/210-657](http://www.wago.com/210-657)**Nr. articol: 210-658**

Operating tool; Blade: 3.5 x 0.5 mm; with a partially insulated shaft; angled; short

[www.wago.com/210-658](http://www.wago.com/210-658)**Nr. articol: 210-720**

Operating tool; Blade: 3.5 x 0.5 mm; with a partially insulated shaft

[www.wago.com/210-720](http://www.wago.com/210-720)**General accessories****Nr. articol: 231-162/003-000**

Male connector for rail-mount terminal blocks; 1.2 x 1.2 mm pins; straight; Pin spacing 5 mm; 2-pole; gray

[www.wago.com/231-162/003-000](http://www.wago.com/231-162/003-000)**Nr. articol: 231-163/003-000**

Male connector for rail-mount terminal blocks; 1.2 x 1.2 mm pins; straight; Pin spacing 5 mm; 3-pole; gray

[www.wago.com/231-163/003-000](http://www.wago.com/231-163/003-000)**Nr. articol: 231-164/003-000**

Male connector for rail-mount terminal blocks; 1.2 x 1.2 mm pins; straight; Pin spacing 5 mm; 4-pole; gray

[www.wago.com/231-164/003-000](http://www.wago.com/231-164/003-000)**Nr. articol: 231-165/003-000**

Male connector for rail-mount terminal blocks; 1.2 x 1.2 mm pins; straight; Pin spacing 5 mm; 5-pole; gray

[www.wago.com/231-165/003-000](http://www.wago.com/231-165/003-000)**Nr. articol: 231-166/003-000**

Male connector for rail-mount terminal blocks; 1.2 x 1.2 mm pins; straight; Pin spacing 5 mm; 6-pole; gray

[www.wago.com/231-166/003-000](http://www.wago.com/231-166/003-000)**Nr. articol: 231-167/003-000**

Male connector for rail-mount terminal blocks; 1.2 x 1.2 mm pins; straight; Pin spacing 5 mm; 7-pole; gray

[www.wago.com/231-167/003-000](http://www.wago.com/231-167/003-000)**Nr. articol: 231-168/003-000**

Male connector for rail-mount terminal blocks; 1.2 x 1.2 mm pins; straight; Pin spacing 5 mm; 8-pole; gray

[www.wago.com/231-168/003-000](http://www.wago.com/231-168/003-000)**Nr. articol: 231-169/003-000**

Male connector for rail-mount terminal blocks; 1.2 x 1.2 mm pins; straight; Pin spacing 5 mm; 9-pole; gray

[www.wago.com/231-169/003-000](http://www.wago.com/231-169/003-000)**Nr. articol: 231-170/003-000**

Male connector for rail-mount terminal blocks; 1.2 x 1.2 mm pins; straight; Pin spacing 5 mm; 10-pole; gray

[www.wago.com/231-170/003-000](http://www.wago.com/231-170/003-000)**Nr. articol: 231-171/003-000**

Male connector for rail-mount terminal blocks; 1.2 x 1.2 mm pins; straight; Pin spacing 5 mm; 11-pole; gray

[www.wago.com/231-171/003-000](http://www.wago.com/231-171/003-000)**Nr. articol: 231-172/003-000**

Male connector for rail-mount terminal blocks; 1.2 x 1.2 mm pins; straight; Pin spacing 5 mm; 12-pole; gray

[www.wago.com/231-172/003-000](http://www.wago.com/231-172/003-000)

Supus modificărilor.

WAGO Kontakttechnik GmbH &amp; Co. KG

/Representative Office Romania















Sos. Pipera-Tunari nr. 1/1

building 1, 2nd floor | 077190 Voluntari, Ilfov

Tel.: +40-(0)31 421 85 68 | Email: info-RO@wago.com

Aveți întrebări despre produsele noastre?







Vă stăm la dispoziție pentru preluarea apelului la +40 (0) 31 421 85 68.

	<b>Nr. articol: 231-176/003-000</b> Male connector for rail-mount terminal blocks; 1.2 x 1.2 mm pins; straight; Pin spacing 5 mm; 16-pole; gray	<a href="http://www.wago.com/231-176/003-000">www.wago.com/231-176/003-000</a>
	<b>Nr. articol: 231-180/003-000</b> Male connector for rail-mount terminal blocks; 1.2 x 1.2 mm pins; straight; Pin spacing 5 mm; 20-pole; gray	<a href="http://www.wago.com/231-180/003-000">www.wago.com/231-180/003-000</a>
	<b>Nr. articol: 231-668</b> Lockout caps; for covering unused clamping units; gray	<a href="http://www.wago.com/231-668">www.wago.com/231-668</a>
	<b>Nr. articol: 231-669</b> Lockout caps; for covering unused clamping units; orange	<a href="http://www.wago.com/231-669">www.wago.com/231-669</a>
	<b>Nr. articol: 721-162/003-000</b> Male connector for rail-mount terminal blocks; 1.2 x 1.2 mm pins; straight; 100% protected against mismatching; Pin spacing 5 mm; 2-pole; light gray	<a href="http://www.wago.com/721-162/003-000">www.wago.com/721-162/003-000</a>
	<b>Nr. articol: 721-163/003-000</b> Male connector for rail-mount terminal blocks; 1.2 x 1.2 mm pins; straight; 100% protected against mismatching; Pin spacing 5 mm; 3-pole; light gray	<a href="http://www.wago.com/721-163/003-000">www.wago.com/721-163/003-000</a>
	<b>Nr. articol: 721-164/003-000</b> Male connector for rail-mount terminal blocks; 1.2 x 1.2 mm pins; straight; 100% protected against mismatching; Pin spacing 5 mm; 4-pole; light gray	<a href="http://www.wago.com/721-164/003-000">www.wago.com/721-164/003-000</a>
	<b>Nr. articol: 721-165/003-000</b> Male connector for rail-mount terminal blocks; 1.2 x 1.2 mm pins; straight; 100% protected against mismatching; Pin spacing 5 mm; 5-pole; light gray	<a href="http://www.wago.com/721-165/003-000">www.wago.com/721-165/003-000</a>
	<b>Nr. articol: 721-166/003-000</b> Male connector for rail-mount terminal blocks; 1.2 x 1.2 mm pins; straight; 100% protected against mismatching; Pin spacing 5 mm; 6-pole; light gray	<a href="http://www.wago.com/721-166/003-000">www.wago.com/721-166/003-000</a>
	<b>Nr. articol: 721-167/003-000</b> Male connector for rail-mount terminal blocks; 1.2 x 1.2 mm pins; straight; 100% protected against mismatching; Pin spacing 5 mm; 7-pole; light gray	<a href="http://www.wago.com/721-167/003-000">www.wago.com/721-167/003-000</a>
	<b>Nr. articol: 721-168/003-000</b> Male connector for rail-mount terminal blocks; 1.2 x 1.2 mm pins; straight; 100% protected against mismatching; Pin spacing 5 mm; 8-pole; light gray	<a href="http://www.wago.com/721-168/003-000">www.wago.com/721-168/003-000</a>
	<b>Nr. articol: 721-169/003-000</b> Male connector for rail-mount terminal blocks; 1.2 x 1.2 mm pins; straight; 100% protected against mismatching; Pin spacing 5 mm; 9-pole; light gray	<a href="http://www.wago.com/721-169/003-000">www.wago.com/721-169/003-000</a>
	<b>Nr. articol: 721-170/003-000</b> Male connector for rail-mount terminal blocks; 1.2 x 1.2 mm pins; straight; 100% protected against mismatching; Pin spacing 5 mm; 10-pole; light gray	<a href="http://www.wago.com/721-170/003-000">www.wago.com/721-170/003-000</a>
	<b>Nr. articol: 721-171/003-000</b> Male connector for rail-mount terminal blocks; 1.2 x 1.2 mm pins; straight; 100% protected against mismatching; Pin spacing 5 mm; 11-pole; light gray	<a href="http://www.wago.com/721-171/003-000">www.wago.com/721-171/003-000</a>

Supus modificărilor.

WAGO Kontakttechnik GmbH & Co. KG  
/Representative Office Romania  
Sos. Pipera-Tunari nr. 1/1  
building 1, 2nd floor | 077190 Voluntari, Ilfov  
Tel.: +40-(0)31 421 85 68 | Email: info-RO@wago.com

Aveți întrebări despre produsele noastre?  
Vă stăm la dispoziție pentru preluarea apelului la +40 (0) 31 421 85 68.

	<b>Nr. articol: 721-172/003-000</b> Male connector for rail-mount terminal blocks; 1.2 x 1.2 mm pins; straight; 100% protected against mismatching; Pin spacing 5 mm; 12-pole; light gray	<a href="http://www.wago.com/721-172/003-000">www.wago.com/721-172/003-000</a>
	<b>Nr. articol: 721-173/003-000</b> Male connector for rail-mount terminal blocks; 1.2 x 1.2 mm pins; straight; 100% protected against mismatching; Pin spacing 5 mm; 13-pole; light gray	<a href="http://www.wago.com/721-173/003-000">www.wago.com/721-173/003-000</a>
	<b>Nr. articol: 721-174/003-000</b> Male connector for rail-mount terminal blocks; 1.2 x 1.2 mm pins; straight; 100% protected against mismatching; Pin spacing 5 mm; 14-pole; light gray	<a href="http://www.wago.com/721-174/003-000">www.wago.com/721-174/003-000</a>
	<b>Nr. articol: 721-175/003-000</b> Male connector for rail-mount terminal blocks; 1.2 x 1.2 mm pins; straight; 100% protected against mismatching; Pin spacing 5 mm; 15-pole; light gray	<a href="http://www.wago.com/721-175/003-000">www.wago.com/721-175/003-000</a>
	<b>Nr. articol: 721-176/003-000</b> Male connector for rail-mount terminal blocks; 1.2 x 1.2 mm pins; straight; 100% protected against mismatching; Pin spacing 5 mm; 16-pole; light gray	<a href="http://www.wago.com/721-176/003-000">www.wago.com/721-176/003-000</a>
	<b>Nr. articol: 721-180/003-000</b> Male connector for rail-mount terminal blocks; 1.2 x 1.2 mm pins; straight; 100% protected against mismatching; Pin spacing 5 mm; 20-pole; light gray	<a href="http://www.wago.com/721-180/003-000">www.wago.com/721-180/003-000</a>
<b>check</b>		
	<b>Nr. articol: 249-141</b> L-type test plug module; modular; with spring-loaded contact pin; Center module; 1,50 mm <sup>2</sup> ; gray	<a href="http://www.wago.com/249-141">www.wago.com/249-141</a>

## Descărcări

### Documentation

#### Additional Information

Technical explanations	Apr 3, 2019	pdf 2,1 MB	Descărcare
------------------------	-------------	---------------	------------

### CAD/CAE-Data

#### CAD data

2D/3D Models 280-524	URL	Descărcare
----------------------	-----	------------

#### CAE data

EPLAN Data Portal 280-524	URL	Descărcare
---------------------------	-----	------------

WSCAD Universe 280-524	URL	Descărcare
------------------------	-----	------------

Supus modificărilor.

WAGO Kontakttechnik GmbH & Co. KG  
/Representative Office Romania  
Sos. Pipera-Tunari nr. 1/1  
building 1, 2nd floor | 077190 Voluntari, Ilfov  
Tel.: +40-(0)31 421 85 68 | Email: info-RO@wago.com

Aveți întrebări despre produsele noastre?  
Vă stăm la dispoziție pentru preluarea apelului la +40 (0) 31 421 85 68.

## Installation Notes

### Assembly

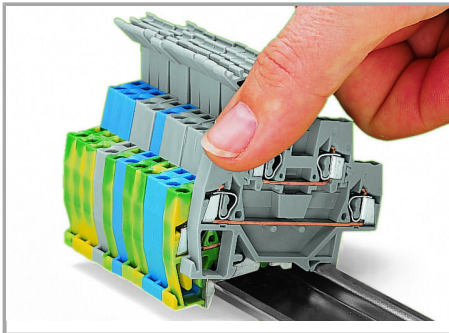

Snapping a terminal block onto the carrier rail.

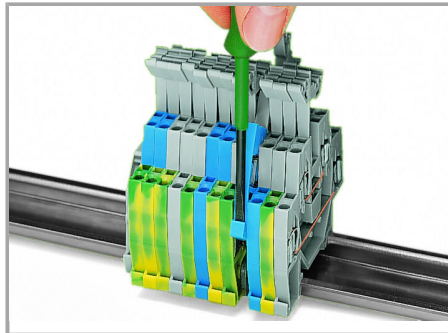

Removing a terminal block from the assembly.

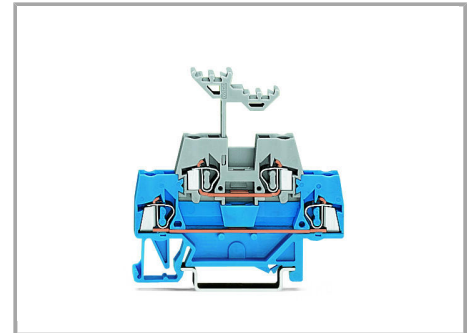

Double-deck terminal blocks accommodate two circuits of different potentials on two decks; different circuits can be differentiated by color coding either deck (280 Series). The lower deck is wider than the upper for ease of wiring.

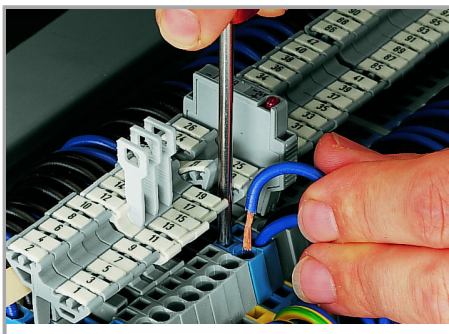

### Jumpered

Supus modificărilor.



Commoning using an adjacent jumper (280-402).

Push jumper down until fully inserted.

#### Jumpered

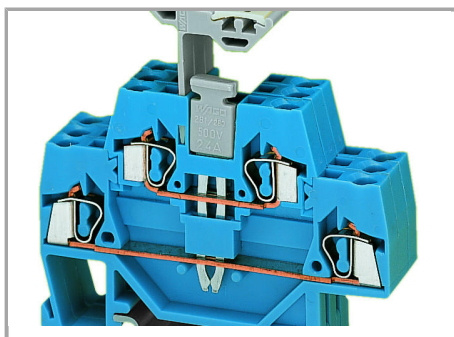

Commoning with a vertical jumper (281-421).

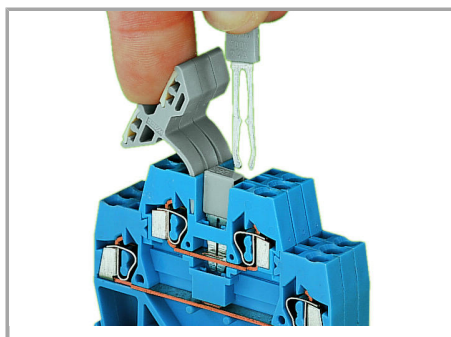

Combining vertical and adjacent jumpers.

Push vertical jumper down until fully inserted.

Supus modificărilor.



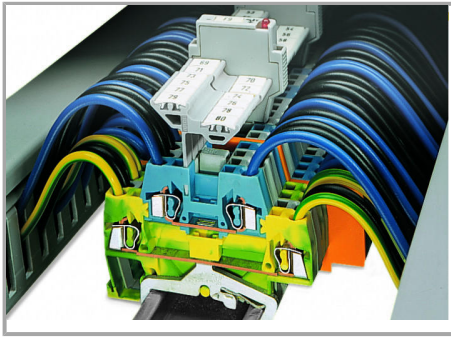

Example of a mixed assembly with double-deck terminal blocks.

The 280 Series Double-Deck Terminal Blocks are available with decks of same or different color according to their function. This is an additional visual aid during wiring, service or maintenance.

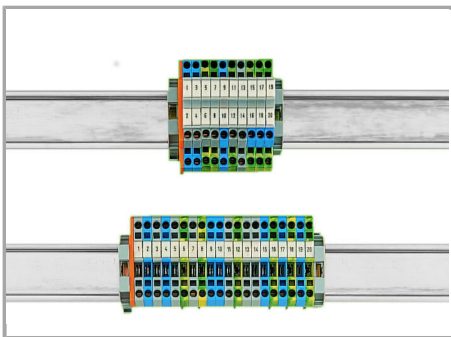

Save 50 % of rail space via double-deck terminal blocks.

## Marking

Supus modificărilor.

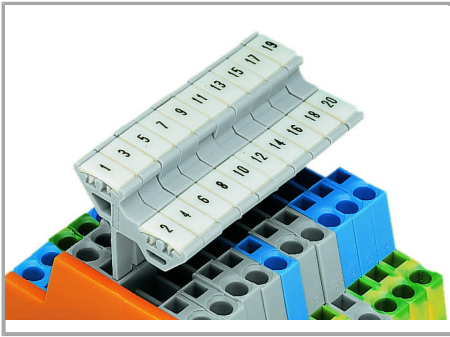

Labeling via WMB Multi Marking System.

Supus modificărilor.