

## Fișă tehnică | Număr articol: 2201-1301

3-conductor through terminal block; with push-button; 1.5 mm<sup>2</sup>; with test port; side and center marking; for DIN-rail 35 x 15 and 35 x 7.5; Push-in CAGE CLAMP®; 1,00 mm<sup>2</sup>; gray

[www.wago.com/2201-1301](http://www.wago.com/2201-1301)

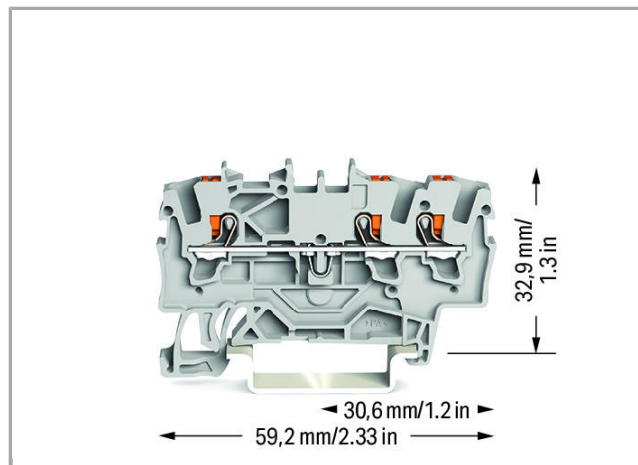
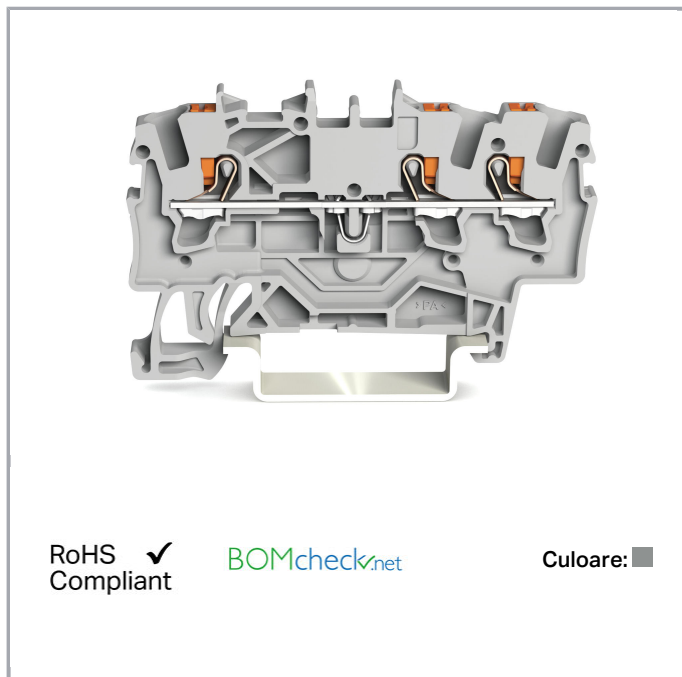

RoHS  
Compliant ✓

BOMcheck.net

Culoare: ■

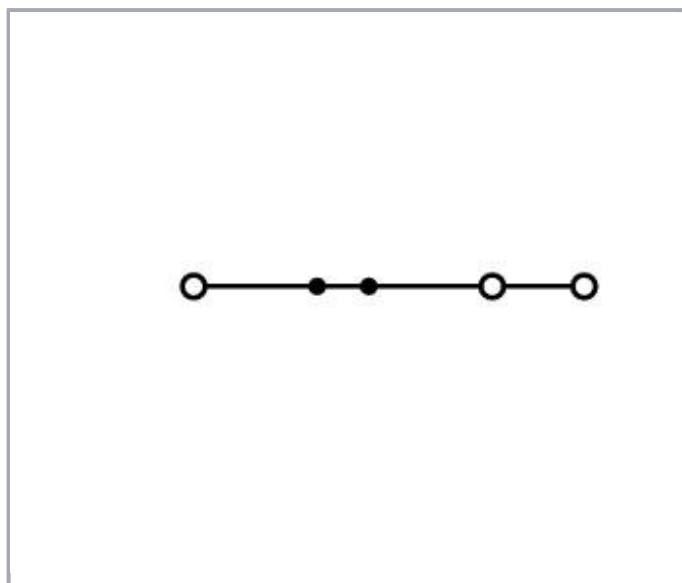

### Date

### Electrical data

Supus modificărilor.

WAGO Kontakttechnik GmbH & Co. KG  
/Representative Office Romania  
Sos. Pipera-Tunari nr. 1/1  
building 1, 2nd floor | 077190 Voluntari, Ilfov  
Tel.: +40-(0)31 421 85 68 | Email: info-RO@wago.com

Aveți întrebări despre produsele noastre?  
Vă stăm la dispoziție pentru preluarea apelului la +40 (0) 31 421 85 68.



### Ratings per IEC/EN 60664-1

Ratings per	IEC/EN 60947-7-1
Nominal voltage (III/3)	800 V
Rated surge voltage (III/3)	8 kV
Rated current	18 A
Rated current 2	24 A
Legend (ratings)	(III / 3) $\triangleq$ Overvoltage category III / Pollution degree 3

### Approvals per UL 1059

Rated voltage UL (Use Group B)	600 V
Rated current UL (Use Group B)	15 A
Rated voltage UL (Use Group C)	600 V
Rated current UL (Use Group C)	15 A
Approvals per	UL 1059

### Connection data

Connection technology	Push-in CAGE CLAMP <sup>®</sup>
Actuation type	Push-in Push-button
Connectable conductor materials	Copper
Nominal cross-section	1,5 mm <sup>2</sup>
Solid conductor	0,25 ... 2,5 mm <sup>2</sup> / 22 ... 14 AWG
Solid conductor; push-in termination	0,75 ... 2,5 mm <sup>2</sup> / 18 ... 14 AWG
Fine-stranded conductor	0,25 ... 2,5 mm <sup>2</sup> / 22 ... 14 AWG
Fine-stranded conductor; with insulated ferrule	0,75 ... 1,5 mm <sup>2</sup> / 18 ... 16 AWG
Fine-stranded conductor; with ferrule; push-in termination	0,75 ... 1,5 mm <sup>2</sup> / 18 ... 16 AWG
Strip length	9 ... 11 mm / 0.35 ... 0.43 inch
Total number of connection points	3
Total number of potentials	1
Number of levels	1
Wiring type	Front-entry wiring
Note (conductor cross-section)	Depending on the conductor characteristic, a conductor with a smaller cross-section can also be inserted via push-in termination.
Number of jumper slots	2

Supus modificărilor.

WAGO Kontakttechnik GmbH & Co. KG  
/Representative Office Romania  
Sos. Pipera-Tunari nr. 1/1  
building 1, 2nd floor | 077190 Voluntari, Ilfov  
Tel.: +40-(0)31 421 85 68 | Email: info-RO@wago.com

Aveți întrebări despre produsele noastre?  
Vă stăm la dispoziție pentru preluarea apelului la +40 (0) 31 421 85 68.

## Geometrical Data

Width	4,2 mm / 0.165 inch
Height from upper-edge of DIN-rail	32,9 mm / 1.295 inch
Depth	59,2 mm / 2.33 inch

## Mechanical data

Design	horizontal type
Mounting type	DIN-35 rail
Marking level	Center/side marking

## Material Data



Color	gray
Insulation material	Polyamide 66 (PA 66)
Weight	5 g

## Commercial data

Packaging type	BOX
Country of origin	DE
GTIN	4055143696791
Customs tariff number	85369010000



## Aprobări / certificate

### Ex-Approvals



Emblemă	Aprobare	Text de aprobare suplimentar	Nume certificat
	ATEX Physikalisch Technische Bundesanstalt	IEC 60079-0	PTB 18 ATEX 1004 U (II 2 G Ex eb IIC Gb bzw. I M 2 Ex eb I Mb)
	IECEX Physikalisch Technische Bundesanstalt	IEC 60079-0	IECEX PTB 18.0011 U (Ex eb IIC Gb)

Supus modificărilor.

## Country specific Approvals

Emblemă	Aprobare	Text de aprobare suplimentar	Nume certificat
	CCA DEKRA Certification B.V.	EN 60947	NTR NL 7664
	CSA DEKRA Certification B.V.	C22.2	70173738
	KEMA/KEUR DEKRA Certification B.V.	EN 60947	71- 102875

## Ship Approvals

Emblemă	Aprobare	Text de aprobare suplimentar	Nume certificat
	ABS American Bureau of Shipping	-	19- HG1866350- PDA
	DNV GL Det Norske Veritas, Germanischer Lloyd	-	TAE00003JT
	LR Lloyds Register	-	19/20050

## UL-Approvals

Emblemă	Aprobare	Text de aprobare suplimentar	Nume certificat
	cURus Underwriters Laboratories Inc.	UL 1059	4788308064

Supus modificărilor.

## Counterpart

## Produce compatibile

## Insulation stop

	<b>Nr. articol: 2001-171</b> Insulation stop; 0.25 - 0.5 mm <sup>2</sup> ; 5 pieces/strip; light gray	<a href="http://www.wago.com/2001-171">www.wago.com/2001-171</a>
--	--	--

## Push-In type wire jumper

	<b>Nr. articol: 2009-412</b> Push-in type wire jumper; insulated; wire length 60 mm; Conductor cross section 1.5 mm <sup>2</sup> ; suitable for 2001, 2002, 2003 and 2022 Series rail-mounted terminal blocks; black	<a href="http://www.wago.com/2009-412">www.wago.com/2009-412</a>
--	---	--

	<b>Nr. articol: 2009-414</b> Push-in type wire jumper; insulated; wire length 110 mm; Conductor cross section 1.5 mm <sup>2</sup> ; suitable for 2001, 2002, 2003 and 2022 Series rail-mounted terminal blocks; black	<a href="http://www.wago.com/2009-414">www.wago.com/2009-414</a>
--	--	--

	<b>Nr. articol: 2009-414/000-005</b> Push-in type wire jumper; insulated; wire length 110 mm; Conductor cross section 1.5 mm <sup>2</sup> ; suitable for 2001, 2002, 2003 and 2022 Series rail-mounted terminal blocks; red	<a href="http://www.wago.com/2009-414/000-005">www.wago.com/2009-414/000-005</a>
--	--	--

	<b>Nr. articol: 2009-414/000-006</b> Push-in type wire jumper; insulated; wire length 110 mm; Conductor cross section 1.5 mm <sup>2</sup> ; suitable for 2001, 2002, 2003 and 2022 Series rail-mounted terminal blocks; blue	<a href="http://www.wago.com/2009-414/000-006">www.wago.com/2009-414/000-006</a>
--	---	--

	<b>Nr. articol: 2009-416</b> Push-in type wire jumper; insulated; wire length 250 mm; Conductor cross section 1.5 mm <sup>2</sup> ; suitable for 2001, 2002, 2003 and 2022 Series rail-mounted terminal blocks; black	<a href="http://www.wago.com/2009-416">www.wago.com/2009-416</a>
--	--	--

## Carrier rail















	<b>Nr. articol: 210-112</b> Steel carrier rail; 35 x 7.5 mm; 1 mm thick; 2 m long; slotted; according to EN 60715; "Hole width 25 mm	<a href="http://www.wago.com/210-112">www.wago.com/210-112</a>
--	---	--

	<b>Nr. articol: 210-113</b> Steel carrier rail; 35 x 7.5 mm; 1 mm thick; 2 m long; unslotted; according to EN 60715	<a href="http://www.wago.com/210-113">www.wago.com/210-113</a>
--	--	--

	<b>Nr. articol: 210-114</b> Steel carrier rail; 35 x 15 mm; 1.5 mm thick; 2 m long; unslotted; similar to EN 60715	<a href="http://www.wago.com/210-114">www.wago.com/210-114</a>
--	---	--

	<b>Nr. articol: 210-115</b> Steel carrier rail; 35 x 7.5 mm; 1 mm thick; 2 m long; slotted; according to EN 60715; "Hole width 18 mm	<a href="http://www.wago.com/210-115">www.wago.com/210-115</a>
--	---	--

















Supus modificărilor.

	<b>Nr. articol: 210-118</b> Steel carrier rail; 35 x 15 mm; 2.3 mm thick; 2 m long; unslotted; according to EN 60715	<a href="http://www.wago.com/210-118">www.wago.com/210-118</a>
	<b>Nr. articol: 210-196</b> Aluminum carrier rail; 35 x 8.2 mm; 1.6 mm thick; 2 m long; unslotted; similar to EN 60715; silver-colored	<a href="http://www.wago.com/210-196">www.wago.com/210-196</a>
	<b>Nr. articol: 210-197</b> Steel carrier rail; 35 x 15 mm; 1.5 mm thick; 2 m long; slotted; similar to EN 60715	<a href="http://www.wago.com/210-197">www.wago.com/210-197</a>
	<b>Nr. articol: 210-198</b> Copper carrier rail; 35 x 15 mm; 2.3 mm thick; 2 m long; unslotted; according to EN 60715; copper-colored	<a href="http://www.wago.com/210-198">www.wago.com/210-198</a>
<b>ferrule</b>		
	<b>Nr. articol: 216-241</b> Ferrule; Sleeve for 0.5 mm <sup>2</sup> / 20 AWG; insulated; electro-tin plated; electrolytic copper; gastight crimped; acc. to DIN 46228, Part 4/09.90; white	<a href="http://www.wago.com/216-241">www.wago.com/216-241</a>
	<b>Nr. articol: 216-242</b> Ferrule; Sleeve for 0.75 mm <sup>2</sup> / 18 AWG; insulated; electro-tin plated; electrolytic copper; gastight crimped; acc. to DIN 46228, Part 4/09.90; gray	<a href="http://www.wago.com/216-242">www.wago.com/216-242</a>
	<b>Nr. articol: 216-243</b> Ferrule; Sleeve for 1 mm <sup>2</sup> / AWG 18; insulated; electro-tin plated; electrolytic copper; gastight crimped; acc. to DIN 46228, Part 4/09.90; red	<a href="http://www.wago.com/216-243">www.wago.com/216-243</a>
	<b>Nr. articol: 216-244</b> Ferrule; Sleeve for 1.5 mm <sup>2</sup> / AWG 16; insulated; electro-tin plated; electrolytic copper; gastight crimped; acc. to DIN 46228, Part 4/09.90; black	<a href="http://www.wago.com/216-244">www.wago.com/216-244</a>
<b>tools</b>		
	<b>Nr. articol: 210-647</b> Operating tool; Blade: 2.5 x 0.4 mm; with a partially insulated shaft	<a href="http://www.wago.com/210-647">www.wago.com/210-647</a>
	<b>Nr. articol: 210-648</b> Operating tool; Blade: 2.5 x 0.4 mm; with a partially insulated shaft; angled; short	<a href="http://www.wago.com/210-648">www.wago.com/210-648</a>
	<b>Nr. articol: 210-719</b> Operating tool; Blade: 2.5 x 0.4 mm; with a partially insulated shaft	<a href="http://www.wago.com/210-719">www.wago.com/210-719</a>
<b>End plate</b>		
	<b>Nr. articol: 2002-1391</b> End and intermediate plate; 0.8 mm thick; gray	<a href="http://www.wago.com/2002-1391">www.wago.com/2002-1391</a>
	<b>Nr. articol: 2002-1392</b> End and intermediate plate; 0.8 mm thick; orange	<a href="http://www.wago.com/2002-1392">www.wago.com/2002-1392</a>
	<b>Nr. articol: 2002-1393</b> Separator plate; 2 mm thick; oversized; gray	<a href="http://www.wago.com/2002-1393">www.wago.com/2002-1393</a>
	<b>Nr. articol: 2002-1394</b> Separator plate; 2 mm thick; oversized; orange	<a href="http://www.wago.com/2002-1394">www.wago.com/2002-1394</a>
<b>Jumper</b>		













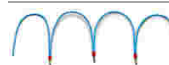

Supus modificărilor.

WAGO Kontakttechnik GmbH & Co. KG  
/Representative Office Romania  
Sos. Pipera-Tunari nr. 1/1  
building 1, 2nd floor | 077190 Voluntari, Ilfov  
Tel.: +40-(0)31 421 85 68 | Email: info-RO@wago.com

Aveți întrebări despre produsele noastre?  
Vă stăm la dispoziție pentru preluarea apelului la +40 (0) 31 421 85 68.

	<b>Nr. articol: 2001-402</b> Push-in type jumper bar; insulated; 2-way; Nominal current 18 A; light gray	<a href="http://www.wago.com/2001-402">www.wago.com/2001-402</a>
	<b>Nr. articol: 2001-403</b> Push-in type jumper bar; insulated; 3-way; Nominal current 18 A; light gray	<a href="http://www.wago.com/2001-403">www.wago.com/2001-403</a>
	<b>Nr. articol: 2001-404</b> Push-in type jumper bar; insulated; 4-way; Nominal current 18 A; light gray	<a href="http://www.wago.com/2001-404">www.wago.com/2001-404</a>
	<b>Nr. articol: 2001-405</b> Push-in type jumper bar; insulated; 5-way; Nominal current 18 A; light gray	<a href="http://www.wago.com/2001-405">www.wago.com/2001-405</a>
	<b>Nr. articol: 2001-405/011-000</b> Star point jumper; insulated; 3-way (1-3-5); IN = IN terminal block; light gray	<a href="http://www.wago.com/2001-405/011-000">www.wago.com/2001-405/011-000</a>
	<b>Nr. articol: 2001-406</b> Push-in type jumper bar; insulated; 6-way; Nominal current 18 A; light gray	<a href="http://www.wago.com/2001-406">www.wago.com/2001-406</a>
	<b>Nr. articol: 2001-406/020-000</b> Delta jumper; insulated; 1-2 3-4 5-6; IN = IN terminal block; light gray	<a href="http://www.wago.com/2001-406/020-000">www.wago.com/2001-406/020-000</a>
	<b>Nr. articol: 2001-407</b> Push-in type jumper bar; insulated; 7-way; Nominal current 18 A; light gray	<a href="http://www.wago.com/2001-407">www.wago.com/2001-407</a>
	<b>Nr. articol: 2001-408</b> Push-in type jumper bar; insulated; 8-way; Nominal current 18 A; light gray	<a href="http://www.wago.com/2001-408">www.wago.com/2001-408</a>
	<b>Nr. articol: 2001-409</b> Push-in type jumper bar; insulated; 9-way; Nominal current 18 A; light gray	<a href="http://www.wago.com/2001-409">www.wago.com/2001-409</a>
	<b>Nr. articol: 2001-410</b> Push-in type jumper bar; insulated; 10-way; Nominal current 18 A; light gray	<a href="http://www.wago.com/2001-410">www.wago.com/2001-410</a>
	<b>Nr. articol: 2001-433</b> Push-in type jumper bar; insulated; from 1 to 3; Nominal current 18 A; light gray	<a href="http://www.wago.com/2001-433">www.wago.com/2001-433</a>
	<b>Nr. articol: 2001-434</b> Push-in type jumper bar; insulated; from 1 to 4; Nominal current 18 A; light gray	<a href="http://www.wago.com/2001-434">www.wago.com/2001-434</a>
	<b>Nr. articol: 2001-435</b> Push-in type jumper bar; insulated; from 1 to 5; Nominal current 18 A; light gray	<a href="http://www.wago.com/2001-435">www.wago.com/2001-435</a>
	<b>Nr. articol: 2001-436</b> Push-in type jumper bar; insulated; from 1 to 6; Nominal current 18 A; light gray	<a href="http://www.wago.com/2001-436">www.wago.com/2001-436</a>
	<b>Nr. articol: 2001-437</b> Push-in type jumper bar; insulated; from 1 to 7; Nominal current 18 A; light gray	<a href="http://www.wago.com/2001-437">www.wago.com/2001-437</a>
	<b>Nr. articol: 2001-438</b> Push-in type jumper bar; insulated; from 1 to 8; Nominal current 18 A; light gray	<a href="http://www.wago.com/2001-438">www.wago.com/2001-438</a>

Supus modificărilor.

	<b>Nr. articol: 2001-439</b> Push-in type jumper bar; insulated; from 1 to 9; Nominal current 18 A; light gray	<a href="http://www.wago.com/2001-439">www.wago.com/2001-439</a>
	<b>Nr. articol: 2001-440</b> Push-in type jumper bar; insulated; from 1 to 10; Nominal current 18 A; light gray	<a href="http://www.wago.com/2001-440">www.wago.com/2001-440</a>
	<b>Nr. articol: 2006-499</b> Step-down jumper; insulated; from 6/4 mm <sup>2</sup> to 4/2.5/1.5 mm <sup>2</sup> ; Nominal current 32 A; light gray	<a href="http://www.wago.com/2006-499">www.wago.com/2006-499</a>
	<b>Nr. articol: 210-103</b> Wire commoning chain; insulated; 50 connections; black	<a href="http://www.wago.com/210-103">www.wago.com/210-103</a>
	<b>Nr. articol: 210-123</b> Wire commoning chain; insulated; 50 connections	<a href="http://www.wago.com/210-123">www.wago.com/210-123</a>
<b>Marking accessories</b>		
	<b>Nr. articol: 2009-110</b> Marking strips; on reel; not stretchable; plain; snap-on type; white	<a href="http://www.wago.com/2009-110">www.wago.com/2009-110</a>
	<b>Nr. articol: 2009-114</b> WMB-Inline; for Smart Printer; 2000 pieces on roll; stretchable 4 - 4.2 mm; plain; snap-on type; white	<a href="http://www.wago.com/2009-114">www.wago.com/2009-114</a>
	<b>Nr. articol: 2009-114/000-002</b> WMB-Inline; for Smart Printer; 2000 pieces on roll; stretchable 4 - 4.2 mm; plain; snap-on type; yellow	<a href="http://www.wago.com/2009-114/000-002">www.wago.com/2009-114 /000-002</a>
	<b>Nr. articol: 2009-114/000-005</b> WMB-Inline; for Smart Printer; 2000 pieces on roll; stretchable 4 - 4.2 mm; plain; snap-on type; red	<a href="http://www.wago.com/2009-114/000-005">www.wago.com/2009-114 /000-005</a>
	<b>Nr. articol: 2009-114/000-006</b> WMB-Inline; for Smart Printer; 2000 pieces on roll; stretchable 4 - 4.2 mm; plain; snap-on type; blue	<a href="http://www.wago.com/2009-114/000-006">www.wago.com/2009-114 /000-006</a>
	<b>Nr. articol: 2009-114/000-007</b> WMB-Inline; for Smart Printer; 2000 pieces on roll; stretchable 4 - 4.2 mm; plain; snap-on type; gray	<a href="http://www.wago.com/2009-114/000-007">www.wago.com/2009-114 /000-007</a>
	<b>Nr. articol: 2009-114/000-012</b> WMB-Inline; for Smart Printer; 2000 pieces on roll; stretchable 4 - 4.2 mm; plain; snap-on type; orange	<a href="http://www.wago.com/2009-114/000-012">www.wago.com/2009-114 /000-012</a>
	<b>Nr. articol: 2009-114/000-023</b> WMB-Inline; for Smart Printer; 2000 pieces on roll; stretchable 4 - 4.2 mm; plain; snap-on type; green	<a href="http://www.wago.com/2009-114/000-023">www.wago.com/2009-114 /000-023</a>
	<b>Nr. articol: 2009-114/000-024</b> WMB-Inline; for Smart Printer; 2000 pieces on roll; stretchable 4 - 4.2 mm; plain; snap-on type; violet	<a href="http://www.wago.com/2009-114/000-024">www.wago.com/2009-114 /000-024</a>
	<b>Nr. articol: 793-4501</b> WMB marking card; as card; stretchable 4 - 4.2 mm; plain; snap-on type; white	<a href="http://www.wago.com/793-4501">www.wago.com/793-4501</a>

Supus modificărilor.





**Nr. articol:** 793-4501/000-002

WMB marking card; as card; stretchable 4 - 4.2 mm; plain; snap-on type; yellow

[www.wago.com/793-4501/000-002](http://www.wago.com/793-4501/000-002)



**Nr. articol:** 793-4501/000-005

WMB marking card; as card; stretchable 4 - 4.2 mm; plain; snap-on type; red

[www.wago.com/793-4501/000-005](http://www.wago.com/793-4501/000-005)



**Nr. articol:** 793-4501/000-006

WMB marking card; as card; stretchable 4 - 4.2 mm; plain; snap-on type; blue

[www.wago.com/793-4501/000-006](http://www.wago.com/793-4501/000-006)



**Nr. articol:** 793-4501/000-007

WMB marking card; as card; stretchable 4 - 4.2 mm; plain; snap-on type; gray

[www.wago.com/793-4501/000-007](http://www.wago.com/793-4501/000-007)



**Nr. articol:** 793-4501/000-012

WMB marking card; as card; stretchable 4 - 4.2 mm; plain; snap-on type; orange

[www.wago.com/793-4501/000-012](http://www.wago.com/793-4501/000-012)



**Nr. articol:** 793-4501/000-017

WMB marking card; as card; stretchable 4 - 4.2 mm; plain; snap-on type; green

[www.wago.com/793-4501/000-017](http://www.wago.com/793-4501/000-017)



**Nr. articol:** 793-4501/000-023

WMB marking card; as card; stretchable 4 - 4.2 mm; plain; snap-on type; light green

[www.wago.com/793-4501/000-023](http://www.wago.com/793-4501/000-023)



**Nr. articol:** 793-4501/000-024

WMB marking card; as card; stretchable 4 - 4.2 mm; plain; snap-on type; violet

[www.wago.com/793-4501/000-024](http://www.wago.com/793-4501/000-024)

#### plug



**Nr. articol:** 2002-880

Empty component plug housing; 10.4 mm wide; 2-pole; Type 4; gray

[www.wago.com/2002-880](http://www.wago.com/2002-880)



**Nr. articol:** 2002-880/1000-411

Component plug; 2-pole; with diode 1N4007; 10.4 mm wide; Operating temperature 85°C max.; gray

[www.wago.com/2002-880/1000-411](http://www.wago.com/2002-880/1000-411)



**Nr. articol:** 2002-880/1000-541

Component plug; 2-pole; LED (red); 10.4 mm wide; Operating temperature 85°C max.; gray

[www.wago.com/2002-880/1000-541](http://www.wago.com/2002-880/1000-541)



**Nr. articol:** 2002-880/1000-542

LED module; with red LED; 10.4 mm wide; 30 - 65 V; Operating temperature 85°C max.

[www.wago.com/2002-880/1000-542](http://www.wago.com/2002-880/1000-542)



**Nr. articol:** 2002-880/1000-836

Component plug; 2-pole; LED (red); 10.4 mm wide; Operating temperature 85°C max.; gray

[www.wago.com/2002-880/1000-836](http://www.wago.com/2002-880/1000-836)

#### check

Supus modificărilor.

WAGO Kontakttechnik GmbH & Co. KG  
/Representative Office Romania  
Sos. Pipera-Tunari nr. 1/1  
building 1, 2nd floor | 077190 Voluntari, Ilfov  
Tel.: +40-(0)31 421 85 68 | Email: info-RO@wago.com

Aveți întrebări despre produsele noastre?  
Vă stăm la dispoziție pentru preluarea apelului la +40 (0) 31 421 85 68.

	<b>Nr. articol: 2001-511</b> Modular TOPJOB®S connector; modular; for jumper contact slot; 1-pole; 1,50 mm <sup>2</sup> ; gray	<a href="http://www.wago.com/2001-511">www.wago.com/2001-511</a>
	<b>Nr. articol: 2001-549</b> Spacer module; modular; e.g., for bridging commoned terminal blocks; gray	<a href="http://www.wago.com/2001-549">www.wago.com/2001-549</a>
	<b>Nr. articol: 2001-552</b> Modular TOPJOB®S connector; modular; for jumper contact slot; 2-pole; 1,50 mm <sup>2</sup> ; gray	<a href="http://www.wago.com/2001-552">www.wago.com/2001-552</a>
	<b>Nr. articol: 2001-553</b> Modular TOPJOB®S connector; modular; for jumper contact slot; 3-pole; 1,50 mm <sup>2</sup> ; gray	<a href="http://www.wago.com/2001-553">www.wago.com/2001-553</a>
	<b>Nr. articol: 2001-554</b> Modular TOPJOB®S connector; modular; for jumper contact slot; 4-pole; 1,50 mm <sup>2</sup> ; gray	<a href="http://www.wago.com/2001-554">www.wago.com/2001-554</a>
	<b>Nr. articol: 2001-555</b> Modular TOPJOB®S connector; modular; for jumper contact slot; 5-pole; 1,50 mm <sup>2</sup> ; gray	<a href="http://www.wago.com/2001-555">www.wago.com/2001-555</a>
	<b>Nr. articol: 2001-556</b> Modular TOPJOB®S connector; modular; for jumper contact slot; 6-pole; 1,50 mm <sup>2</sup> ; gray	<a href="http://www.wago.com/2001-556">www.wago.com/2001-556</a>
	<b>Nr. articol: 2001-557</b> Modular TOPJOB®S connector; modular; for jumper contact slot; 7-pole; 1,50 mm <sup>2</sup> ; gray	<a href="http://www.wago.com/2001-557">www.wago.com/2001-557</a>
	<b>Nr. articol: 2001-558</b> Modular TOPJOB®S connector; modular; for jumper contact slot; 8-pole; 1,50 mm <sup>2</sup> ; gray	<a href="http://www.wago.com/2001-558">www.wago.com/2001-558</a>
	<b>Nr. articol: 2001-559</b> Modular TOPJOB®S connector; modular; for jumper contact slot; 9-pole; 1,50 mm <sup>2</sup> ; gray	<a href="http://www.wago.com/2001-559">www.wago.com/2001-559</a>
	<b>Nr. articol: 2001-560</b> Modular TOPJOB®S connector; modular; for jumper contact slot; 10-pole; 1,50 mm <sup>2</sup> ; gray	<a href="http://www.wago.com/2001-560">www.wago.com/2001-560</a>
	<b>Nr. articol: 2009-174</b> Test plug adapter; for 4 mm Ø test plugs; for testing TOPJOB®S rail-mounted terminal blocks; gray	<a href="http://www.wago.com/2009-174">www.wago.com/2009-174</a>
	<b>Nr. articol: 2009-182</b> Testing tap; for max. 2.5 mm <sup>2</sup> ; tool-free connection for individual test wires 0.08 - 2.5 mm; gray	<a href="http://www.wago.com/2009-182">www.wago.com/2009-182</a>

## Descărcări

### Documentation

#### Additional Information

Technical explanations	Apr 3, 2019	pdf 2,1 MB	Descărcare
------------------------	-------------	---------------	------------

## CAD/CAE-Data

### CAD data

2D/3D Models 2201-1301

Supus modificărilor.

WAGO Kontakttechnik GmbH & Co. KG  
/Representative Office Romania  
Sos. Pipera-Tunari nr. 1/1  
building 1, 2nd floor | 077190 Voluntari, Ilfov  
Tel.: +40-(0)31 421 85 68 | Email: info-RO@wago.com

Aveți întrebări despre produsele noastre?  
Vă stăm la dispoziție pentru preluarea apelului la +40 (0) 31 421 85 68.

[URL](#)

[Descărcare](#)

---

#### CAE data

EPLAN Data Portal 2201-1301

[URL](#)

[Descărcare](#)

---

### Installation Notes

#### Conductor termination

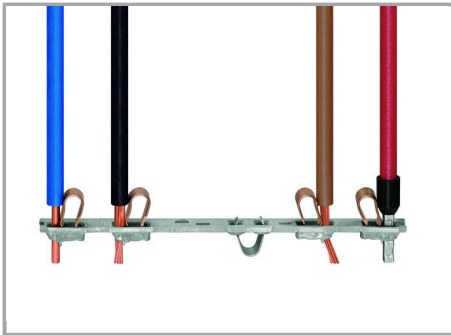

All conductor types at a glance

### Familie de produse

#### TOPJOB® S

TOPJOB® S: In various industrial applications and modern building installations, WAGO's wide and versatile range of rail-mount terminal blocks provides more than just reliable electrical connections.

[Afișare globală produse din familie.](#)

Supus modificărilor.