

## Fișă tehnică | Număr articol: 870-826

Double potential terminal block; 2.5 mm<sup>2</sup>; side and center marking; for DIN-rail 35 x 15 and 35 x 7.5; CAGE CLAMP®; 2,50 mm<sup>2</sup>; gray

[www.wago.com/870-826](http://www.wago.com/870-826)

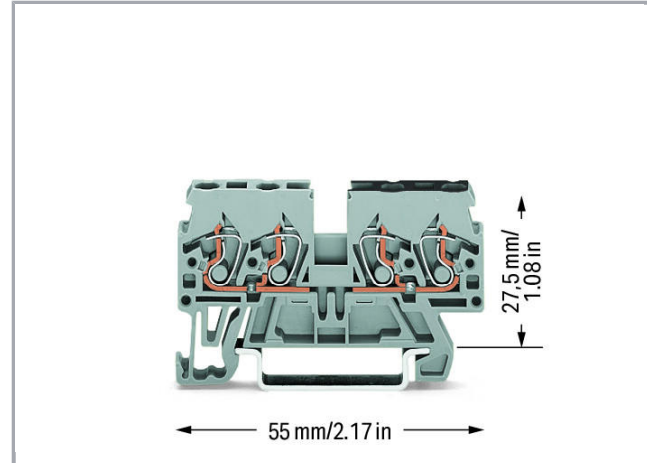
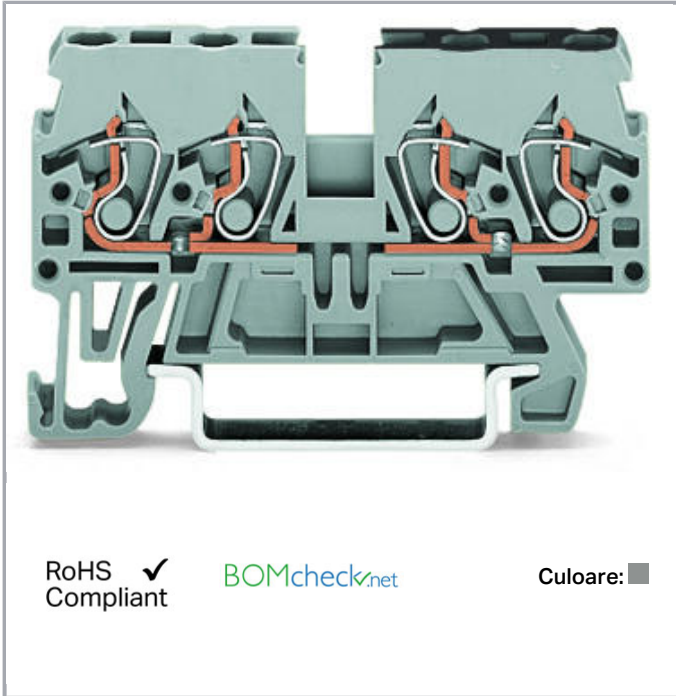

### Descriere articol

#### Safety information 1:

Notice: This double-potential terminal block cannot be commoned with push-in type jumper bars!

#### Safety information 2:

Max. insulation diameter: 4.4 mm

### Date

#### Electrical data

#### Ratings per IEC/EN 60664-1

| Ratings per                 | IEC/EN 60947-7-1  |
|-----------------------------|---|
| Nominal voltage (III/3)     | 500 V   |
| Rated surge voltage (III/3) | 6 kV  |
| Rated current               | 24 A  |
| Legend (ratings)            | (III / 3) ≙ Overvoltage category III / Pollution degree 3 |

Supus modificărilor.

WAGO Kontakttechnik GmbH & Co. KG  
/Representative Office Romania  
Sos. Pipera-Tunari nr. 1/1  
building 1, 2nd floor | 077190 Voluntari, Ilfov  
Tel.: +40-(0)31 421 85 68 | Email: [info-RO@wago.com](mailto:info-RO@wago.com)

Aveți întrebări despre produsele noastre?  
Vă stăm la dispoziție pentru preluarea apelului la +40 (0) 31 421 85 68.



## Connection data

|                                   |  |
|-----------------------------------|--|
| Connection technology             | CAGE CLAMP®                                  |
| Actuation type                    | Operating tool                               |
| Connectable conductor materials   | Copper                                       |
| Solid conductor                   | 0,08 ... 2,5 mm <sup>2</sup> / 28 ... 12 AWG |
| Fine-stranded conductor           | 0,08 ... 4 mm <sup>2</sup> / 28 ... 12 AWG   |
| Strip length                      | 6 ... 7 mm / 0.24 ... 0.28 inch              |
| Total number of connection points | 4  |
| Total number of potentials        | 2  |
| Number of levels                  | 1  |
| Wiring type                       | Front-entry wiring                           |

## Geometrical Data

|                                    |                      |
|------------------------------------|----------------------|
| Width                              | 5 mm / 0.197 inch    |
| Height from upper-edge of DIN-rail | 27,5 mm / 1.083 inch |
| Depth                              | 55 mm / 2.165 inch   |

## Mechanical data

|               |                 |
|---------------|-----------------|
| Design        | horizontal type |
| Mounting type | DIN-35 rail     |
| Marking level | Side marking    |

## Material Data

|                     |                      |
|---------------------|----------------------|
| Color               | gray                 |
| Insulation material | Polyamide 66 (PA 66) |
| Fire load           | 0,119 MJ             |
| Weight              | 7,4 g                |

## Commercial data

|                       |               |
|-----------------------|---------------|
| Packaging type        | BOX           |
| Country of origin     | DE            |
| GTIN                  | 4045454094614 |
| Customs tariff number | 85369010000   |



Supus modificărilor.

WAGO Kontakttechnik GmbH & Co. KG  
 /Representative Office Romania  
 Sos. Pipera-Tunari nr. 1/1  
 building 1, 2nd floor | 077190 Voluntari, Ilfov  
 Tel.: +40-(0)31 421 85 68 | Email: info-RO@wago.com



Aveți întrebări despre produsele noastre?  
 Vă stăm la dispoziție pentru preluarea apelului la +40 (0) 31 421 85 68.

## Aprobări / certificate

### Country specific Approvals

| Emblemă  | Aprobare                        | Text de aprobare suplimentar | Nume certificat |
|--|---------------------------------|------------------------------|-----------------|
|  | CCA<br>DEKRA Certification B.V. | EN 60947                     | NTR NL<br>7468  |
|  | CCA<br>DEKRA Certification B.V. | EN 60947                     | 2189801.01      |

### Ship Approvals

| Emblemă  | Aprobare   | Text de aprobare suplimentar | Nume certificat          |
|--|--|------------------------------|--------------------------|
|    | ABS<br>American Bureau of Shipping               | -                            | 20-<br>HG1941090-<br>PDA |
|  | DNV GL<br>Det Norske Veritas, Germanischer Lloyd | -                            | TAE00001V2               |

### UL-Approvals

| Emblemă  | Aprobare                               | Text de aprobare suplimentar | Nume certificat     |
|--|--|------------------------------|---------------------|
|  | cURus<br>UL International Germany GmbH | UL 1059                      | 20160928-<br>E45172 |

## Counterpart

## Produse compatibile

Supus modificărilor.

WAGO Kontakttechnik GmbH & Co. KG  
/Representative Office Romania  
Sos. Pipera-Tunari nr. 1/1  
building 1, 2nd floor | 077190 Voluntari, Ilfov  
Tel.: +40-(0)31 421 85 68 | Email: info-RO@wago.com

Aveți întrebări despre produsele noastre?  
Vă stăm la dispoziție pentru preluarea apelului la +40 (0) 31 421 85 68.

### Protective Warning Marker



**Nr. articol: 280-405**

Protective warning marker; with high-voltage symbol, black; for 5 terminal blocks; yellow

[www.wago.com/280-405](http://www.wago.com/280-405)

### Carrier rail



**Nr. articol: 210-112**

Steel carrier rail; 35 x 7.5 mm; 1 mm thick; 2 m long; slotted; according to EN 60715; "Hole width 25 mm

[www.wago.com/210-112](http://www.wago.com/210-112)



**Nr. articol: 210-113**

Steel carrier rail; 35 x 7.5 mm; 1 mm thick; 2 m long; unslotted; according to EN 60715

[www.wago.com/210-113](http://www.wago.com/210-113)



**Nr. articol: 210-114**

Steel carrier rail; 35 x 15 mm; 1.5 mm thick; 2 m long; unslotted; similar to EN 60715

[www.wago.com/210-114](http://www.wago.com/210-114)



**Nr. articol: 210-115**

Steel carrier rail; 35 x 7.5 mm; 1 mm thick; 2 m long; slotted; according to EN 60715; "Hole width 18 mm

[www.wago.com/210-115](http://www.wago.com/210-115)



**Nr. articol: 210-118**

Steel carrier rail; 35 x 15 mm; 2.3 mm thick; 2 m long; unslotted; according to EN 60715

[www.wago.com/210-118](http://www.wago.com/210-118)



**Nr. articol: 210-196**

Aluminum carrier rail; 35 x 8.2 mm; 1.6 mm thick; 2 m long; unslotted; similar to EN 60715; silver-colored

[www.wago.com/210-196](http://www.wago.com/210-196)



**Nr. articol: 210-197**

Steel carrier rail; 35 x 15 mm; 1.5 mm thick; 2 m long; slotted; similar to EN 60715

[www.wago.com/210-197](http://www.wago.com/210-197)



**Nr. articol: 210-198**

Copper carrier rail; 35 x 15 mm; 2.3 mm thick; 2 m long; unslotted; according to EN 60715; copper-colored

[www.wago.com/210-198](http://www.wago.com/210-198)



**Nr. articol: 210-504**

Steel carrier rail; 35 x 7.5 mm; 1 mm thick; 2 m long; slotted; galvanized; according to EN 60715

[www.wago.com/210-504](http://www.wago.com/210-504)



**Nr. articol: 210-505**

Steel carrier rail; 35 x 7.5 mm; 1 mm thick; 2 m long; unslotted; galvanized; according to EN 60715

[www.wago.com/210-505](http://www.wago.com/210-505)



**Nr. articol: 210-506**

Steel carrier rail; 35 x 15 mm; 1.5 mm thick; 2 m long; unslotted; galvanized; similar to EN 60715

[www.wago.com/210-506](http://www.wago.com/210-506)



**Nr. articol: 210-508**

Steel carrier rail; 35 x 15 mm; 1.5 mm thick; 2 m long; slotted; galvanized; similar to EN 60715

[www.wago.com/210-508](http://www.wago.com/210-508)

### Jumper



**Nr. articol: 709-110**

Wire commoning chain; insulated; 4 connections; 3 x 110 mm; black

[www.wago.com/709-110](http://www.wago.com/709-110)



**Nr. articol: 709-111**

Wire commoning chain; insulated; 3 connections; 2 x 120 mm; black

[www.wago.com/709-111](http://www.wago.com/709-111)

Supus modificărilor.

**Nr. articol: 709-112**

Wire commoning chain; insulated; 3 connections; 2 x 170 mm; black

[www.wago.com/709-112](http://www.wago.com/709-112)

## tools

**Nr. articol: 210-657**

Operating tool; Blade: 3.5 x 0.5 mm; with a partially insulated shaft; short

[www.wago.com/210-657](http://www.wago.com/210-657)**Nr. articol: 210-658**

Operating tool; Blade: 3.5 x 0.5 mm; with a partially insulated shaft; angled; short

[www.wago.com/210-658](http://www.wago.com/210-658)**Nr. articol: 210-720**

Operating tool; Blade: 3.5 x 0.5 mm; with a partially insulated shaft

[www.wago.com/210-720](http://www.wago.com/210-720)

## Marking accessories

**Nr. articol: 2009-115**

WMB-Inline; for Smart Printer; 1500 pieces on roll; stretchable 5 - 5.2 mm; plain; snap-on type; white

[www.wago.com/2009-115](http://www.wago.com/2009-115)**Nr. articol: 2009-115/000-002**

WMB-Inline; for Smart Printer; 1500 pieces on roll; stretchable 5 - 5.2 mm; plain; snap-on type; yellow

[www.wago.com/2009-115/000-002](http://www.wago.com/2009-115/000-002)**Nr. articol: 2009-115/000-006**

WMB-Inline; for Smart Printer; 1500 pieces on roll; stretchable 5 - 5.2 mm; plain; snap-on type; blue

[www.wago.com/2009-115/000-006](http://www.wago.com/2009-115/000-006)**Nr. articol: 2009-115/000-007**

WMB-Inline; for Smart Printer; 1500 pieces on roll; stretchable 5 - 5.2 mm; plain; snap-on type; gray

[www.wago.com/2009-115/000-007](http://www.wago.com/2009-115/000-007)**Nr. articol: 2009-115/000-012**

WMB-Inline; for Smart Printer; 1500 pieces on roll; stretchable 5 - 5.2 mm; plain; snap-on type; orange

[www.wago.com/2009-115/000-012](http://www.wago.com/2009-115/000-012)**Nr. articol: 2009-115/000-017**

WMB-Inline; for Smart Printer; 1500 pieces on roll; stretchable 5 - 5.2 mm; plain; snap-on type; light green

[www.wago.com/2009-115/000-017](http://www.wago.com/2009-115/000-017)**Nr. articol: 2009-115/000-023**

WMB-Inline; for Smart Printer; 1500 pieces on roll; stretchable 5 - 5.2 mm; plain; snap-on type; green

[www.wago.com/2009-115/000-023](http://www.wago.com/2009-115/000-023)**Nr. articol: 2009-115/000-024**

WMB-Inline; for Smart Printer; 1500 pieces on roll; stretchable 5 - 5.2 mm; plain; snap-on type; violet

[www.wago.com/2009-115/000-024](http://www.wago.com/2009-115/000-024)**Nr. articol: 2009-145**













Mini-WSB Inline; for Smart Printer; 1700 pieces on roll; stretchable 5 - 5.2 mm; plain; snap-on type; white

[www.wago.com/2009-145](http://www.wago.com/2009-145)**Nr. articol: 2009-145/000-002**

Mini-WSB Inline; for Smart Printer; 1700 pieces on roll; stretchable 5 - 5.2 mm; plain; snap-on type; yellow

[www.wago.com/2009-145/000-002](http://www.wago.com/2009-145/000-002)

Supus modificărilor.

|  |  |  |
|--|--|--|
|    | <b>Nr. articol: 2009-145/000-005</b><br>Mini-WSB Inline; for Smart Printer; 1700 pieces on roll; stretchable 5 - 5.2 mm; plain; snap-on type; red    | <a href="http://www.wago.com/2009-145/000-005">www.wago.com/2009-145/000-005</a> |
|    | <b>Nr. articol: 2009-145/000-006</b><br>Mini-WSB Inline; for Smart Printer; 1700 pieces on roll; stretchable 5 - 5.2 mm; plain; snap-on type; blue   | <a href="http://www.wago.com/2009-145/000-006">www.wago.com/2009-145/000-006</a> |
|    | <b>Nr. articol: 2009-145/000-007</b><br>Mini-WSB Inline; for Smart Printer; 1700 pieces on roll; stretchable 5 - 5.2 mm; plain; snap-on type; gray   | <a href="http://www.wago.com/2009-145/000-007">www.wago.com/2009-145/000-007</a> |
|    | <b>Nr. articol: 2009-145/000-012</b><br>Mini-WSB Inline; for Smart Printer; 1700 pieces on roll; stretchable 5 - 5.2 mm; plain; snap-on type; orange | <a href="http://www.wago.com/2009-145/000-012">www.wago.com/2009-145/000-012</a> |
|    | <b>Nr. articol: 2009-145/000-023</b><br>Mini-WSB Inline; for Smart Printer; 1700 pieces on roll; stretchable 5 - 5.2 mm; plain; snap-on type; green  | <a href="http://www.wago.com/2009-145/000-023">www.wago.com/2009-145/000-023</a> |
|    | <b>Nr. articol: 2009-145/000-024</b><br>Mini-WSB Inline; for Smart Printer; 1700 pieces on roll; stretchable 5 - 5.2 mm; plain; snap-on type; violet | <a href="http://www.wago.com/2009-145/000-024">www.wago.com/2009-145/000-024</a> |
|    | <b>Nr. articol: 248-501</b><br>Miniature WSB Quick marking system; plain; Marker width 5 mm; 10 strips with 10 markers per card                      | <a href="http://www.wago.com/248-501">www.wago.com/248-501</a>                   |
|  | <b>Nr. articol: 248-501/000-002</b><br>Mini-WSB marking card; as card; not stretchable; plain; snap-on type; yellow                                  | <a href="http://www.wago.com/248-501/000-002">www.wago.com/248-501/000-002</a>   |
|  | <b>Nr. articol: 248-501/000-005</b><br>Mini-WSB marking card; as card; not stretchable; plain; snap-on type; red                                     | <a href="http://www.wago.com/248-501/000-005">www.wago.com/248-501/000-005</a>   |
|  | <b>Nr. articol: 248-501/000-006</b><br>Mini-WSB marking card; as card; not stretchable; plain; snap-on type; blue                                    | <a href="http://www.wago.com/248-501/000-006">www.wago.com/248-501/000-006</a>   |
|  | <b>Nr. articol: 248-501/000-007</b><br>Mini-WSB marking card; as card; not stretchable; plain; snap-on type; gray                                    | <a href="http://www.wago.com/248-501/000-007">www.wago.com/248-501/000-007</a>   |
|  | <b>Nr. articol: 248-501/000-012</b><br>Mini-WSB marking card; as card; not stretchable; plain; snap-on type; orange                                  | <a href="http://www.wago.com/248-501/000-012">www.wago.com/248-501/000-012</a>   |
|  | <b>Nr. articol: 248-501/000-017</b><br>Mini-WSB marking card; as card; not stretchable; plain; snap-on type; light green                             | <a href="http://www.wago.com/248-501/000-017">www.wago.com/248-501/000-017</a>   |

Supus modificărilor.



**Nr. articol: 248-501/000-023**

Mini-WSB marking card; as card; not stretchable; plain; snap-on type; green

[www.wago.com/248-501/000-023](http://www.wago.com/248-501/000-023)



**Nr. articol: 248-501/000-024**

Mini-WSB marking card; as card; not stretchable; plain; snap-on type; violet

[www.wago.com/248-501/000-024](http://www.wago.com/248-501/000-024)



**Nr. articol: 709-177**

Marking strips; on reel; 7.5 mm wide; not stretchable; plain; snap-on type; translucent

[www.wago.com/709-177](http://www.wago.com/709-177)



**Nr. articol: 709-178**

Marking strips; on reel; 7.5 mm wide; not stretchable; plain; snap-on type; white

[www.wago.com/709-178](http://www.wago.com/709-178)



**Nr. articol: 709-196**

Marking strips; for laser printer; translucent

[www.wago.com/709-196](http://www.wago.com/709-196)



**Nr. articol: 709-198**

Marking strips; white

[www.wago.com/709-198](http://www.wago.com/709-198)



**Nr. articol: 793-501**

WMB marking card; as card; not stretchable; plain; snap-on type; white

[www.wago.com/793-501](http://www.wago.com/793-501)



**Nr. articol: 793-501/000-002**

WMB marking card; as card; not stretchable; plain; snap-on type; yellow

[www.wago.com/793-501/000-002](http://www.wago.com/793-501/000-002)



**Nr. articol: 793-501/000-005**

WMB marking card; as card; not stretchable; plain; snap-on type; red

[www.wago.com/793-501/000-005](http://www.wago.com/793-501/000-005)



**Nr. articol: 793-501/000-006**

WMB marking card; as card; not stretchable; plain; snap-on type; blue

[www.wago.com/793-501/000-006](http://www.wago.com/793-501/000-006)



**Nr. articol: 793-501/000-007**

WMB marking card; as card; not stretchable; plain; snap-on type; gray

[www.wago.com/793-501/000-007](http://www.wago.com/793-501/000-007)



**Nr. articol: 793-501/000-012**

WMB marking card; as card; not stretchable; plain; snap-on type; orange

[www.wago.com/793-501/000-012](http://www.wago.com/793-501/000-012)



**Nr. articol: 793-501/000-017**

WMB marking card; as card; not stretchable; plain; snap-on type; light green

[www.wago.com/793-501/000-017](http://www.wago.com/793-501/000-017)



**Nr. articol: 793-501/000-023**

WMB marking card; as card; not stretchable; plain; snap-on type; green

[www.wago.com/793-501/000-023](http://www.wago.com/793-501/000-023)

















**Nr. articol: 793-501/000-024**

WMB marking card; as card; not stretchable; plain; snap-on type; violet

















[www.wago.com/793-501/000-024](http://www.wago.com/793-501/000-024)

Supus modificărilor.

|  |   |  |
|--|---|--|
|    | <b>Nr. articol: 793-5501</b><br>WMB marking card; as card; for terminal block width 5 - 17.5 mm; stretchable 5 - 5.2 mm; plain; snap-on type; white               | <a href="http://www.wago.com/793-5501">www.wago.com/793-5501</a>                 |
|    | <b>Nr. articol: 793-5501/000-002</b><br>WMB marking card; as card; for terminal block width 5 - 17.5 mm; stretchable 5 - 5.2 mm; plain; snap-on type; yellow      | <a href="http://www.wago.com/793-5501/000-002">www.wago.com/793-5501/000-002</a> |
|    | <b>Nr. articol: 793-5501/000-005</b><br>WMB marking card; as card; for terminal block width 5 - 17.5 mm; stretchable 5 - 5.2 mm; plain; snap-on type; red         | <a href="http://www.wago.com/793-5501/000-005">www.wago.com/793-5501/000-005</a> |
|    | <b>Nr. articol: 793-5501/000-006</b><br>WMB marking card; as card; for terminal block width 5 - 17.5 mm; stretchable 5 - 5.2 mm; plain; snap-on type; blue        | <a href="http://www.wago.com/793-5501/000-006">www.wago.com/793-5501/000-006</a> |
|    | <b>Nr. articol: 793-5501/000-007</b><br>WMB marking card; as card; for terminal block width 5 - 17.5 mm; stretchable 5 - 5.2 mm; plain; snap-on type; gray        | <a href="http://www.wago.com/793-5501/000-007">www.wago.com/793-5501/000-007</a> |
|    | <b>Nr. articol: 793-5501/000-012</b><br>WMB marking card; as card; for terminal block width 5 - 17.5 mm; stretchable 5 - 5.2 mm; plain; snap-on type; orange      | <a href="http://www.wago.com/793-5501/000-012">www.wago.com/793-5501/000-012</a> |
|   | <b>Nr. articol: 793-5501/000-017</b><br>WMB marking card; as card; for terminal block width 5 - 17.5 mm; stretchable 5 - 5.2 mm; plain; snap-on type; green       | <a href="http://www.wago.com/793-5501/000-017">www.wago.com/793-5501/000-017</a> |
|  | <b>Nr. articol: 793-5501/000-023</b><br>WMB marking card; as card; for terminal block width 5 - 17.5 mm; stretchable 5 - 5.2 mm; plain; snap-on type; light green | <a href="http://www.wago.com/793-5501/000-023">www.wago.com/793-5501/000-023</a> |
|  | <b>Nr. articol: 793-5501/000-024</b><br>WMB marking card; as card; for terminal block width 5 - 17.5 mm; stretchable 5 - 5.2 mm; plain; snap-on type; violet      | <a href="http://www.wago.com/793-5501/000-024">www.wago.com/793-5501/000-024</a> |
| <b>assembling</b>  |   |  |
|  | <b>Nr. articol: 209-106</b><br>Mounting carrier; for isolated mounting on DIN 35 rails; gray  | <a href="http://www.wago.com/209-106">www.wago.com/209-106</a>                   |
|  | <b>Nr. articol: 249-116</b><br>Screwless end stop; 6 mm wide; for DIN-rail 35 x 15 and 35 x 7.5; gray   | <a href="http://www.wago.com/249-116">www.wago.com/249-116</a>                   |
|  | <b>Nr. articol: 249-117</b><br>Screwless end stop; 10 mm wide; for DIN-rail 35 x 15 and 35 x 7.5; gray  | <a href="http://www.wago.com/249-117">www.wago.com/249-117</a>                   |
| <b>End plate</b>   |   |  |
|  | <b>Nr. articol: 870-943</b><br>End and intermediate plate; 1 mm thick; gray   | <a href="http://www.wago.com/870-943">www.wago.com/870-943</a>                   |
|  | <b>Nr. articol: 870-944</b><br>End and intermediate plate; 1 mm thick; orange   | <a href="http://www.wago.com/870-944">www.wago.com/870-944</a>                   |

Supus modificărilor.



|  |   |  |
|--|---|--|
|    | <b>Nr. articol: 870-948</b><br>Separator plate; 1 mm thick; gray  | <a href="http://www.wago.com/870-948">www.wago.com/870-948</a> |
|    | <b>Nr. articol: 870-949</b><br>Separator plate; 1 mm thick; orange  | <a href="http://www.wago.com/870-949">www.wago.com/870-949</a> |
| <b>ferrule</b>   |   |  |
|    | <b>Nr. articol: 216-121</b><br>Ferrule; Sleeve for 0.5 mm <sup>2</sup> / AWG 22; uninsulated; electro-tin plated                    | <a href="http://www.wago.com/216-121">www.wago.com/216-121</a> |
|    | <b>Nr. articol: 216-122</b><br>Ferrule; Sleeve for 0.75 mm <sup>2</sup> / AWG 20; uninsulated; electro-tin plated                   | <a href="http://www.wago.com/216-122">www.wago.com/216-122</a> |
|    | <b>Nr. articol: 216-123</b><br>Ferrule; Sleeve for 1 mm <sup>2</sup> / AWG 18; uninsulated; electro-tin plated                      | <a href="http://www.wago.com/216-123">www.wago.com/216-123</a> |
|    | <b>Nr. articol: 216-124</b><br>Ferrule; Sleeve for 1.5 mm <sup>2</sup> / AWG 16; uninsulated; electro-tin plated                    | <a href="http://www.wago.com/216-124">www.wago.com/216-124</a> |
|    | <b>Nr. articol: 216-131</b><br>Ferrule; Sleeve for 0.25 mm <sup>2</sup> / AWG 24; uninsulated; electro-tin plated                   | <a href="http://www.wago.com/216-131">www.wago.com/216-131</a> |
|    | <b>Nr. articol: 216-132</b><br>Ferrule; Sleeve for 0.34 mm <sup>2</sup> / AWG 24; uninsulated; electro-tin plated                   | <a href="http://www.wago.com/216-132">www.wago.com/216-132</a> |
|    | <b>Nr. articol: 216-221</b><br>Ferrule; Sleeve for 0.5 mm <sup>2</sup> / 20 AWG; insulated; electro-tin plated; white               | <a href="http://www.wago.com/216-221">www.wago.com/216-221</a> |
|  | <b>Nr. articol: 216-222</b><br>Ferrule; Sleeve for 0.75 mm <sup>2</sup> / 18 AWG; insulated; electro-tin plated; gray               | <a href="http://www.wago.com/216-222">www.wago.com/216-222</a> |
|  | <b>Nr. articol: 216-223</b><br>Ferrule; Sleeve for 1 mm <sup>2</sup> / AWG 18; insulated; electro-tin plated; red                   | <a href="http://www.wago.com/216-223">www.wago.com/216-223</a> |
|  | <b>Nr. articol: 216-224</b><br>Ferrule; Sleeve for 1.5 mm <sup>2</sup> / AWG 16; insulated; electro-tin plated; black               | <a href="http://www.wago.com/216-224">www.wago.com/216-224</a> |
|  | <b>Nr. articol: 216-321</b><br>Ferrule; Sleeve for 0.25 mm <sup>2</sup> / AWG 24; insulated; electro-tin plated; yellow             | <a href="http://www.wago.com/216-321">www.wago.com/216-321</a> |
|  | <b>Nr. articol: 216-322</b><br>Ferrule; Sleeve for 0.34 mm <sup>2</sup> / 22 AWG; insulated; electro-tin plated; green              | <a href="http://www.wago.com/216-322">www.wago.com/216-322</a> |
| <b>Insulation stop</b>   |   |  |
|  | <b>Nr. articol: 280-470</b><br>Insulation stop; 0.08 - 0.2 mm <sup>2</sup> "s" (0.14 mm <sup>2</sup> "f-st"); 5 pieces/strip; white | <a href="http://www.wago.com/280-470">www.wago.com/280-470</a> |
|  | <b>Nr. articol: 280-471</b><br>Insulation stop; 0.25 - 0.5 mm <sup>2</sup> ; 5 pieces/strip; light gray                             | <a href="http://www.wago.com/280-471">www.wago.com/280-471</a> |
|  | <b>Nr. articol: 280-472</b><br>Insulation stop; 0.75 - 1 mm <sup>2</sup> ; 5 pieces/strip   | <a href="http://www.wago.com/280-472">www.wago.com/280-472</a> |

Supus modificărilor.

## Descărcări Documentation

### Additional Information

|                        |             |               |            |
|------------------------|-------------|---------------|------------|
| Technical explanations | Apr 3, 2019 | pdf<br>2,1 MB | Descărcare |
|------------------------|-------------|---------------|------------|

## CAD/CAE-Data

### CAD data

|                      |     |            |
|----------------------|-----|------------|
| 2D/3D Models 870-826 | URL | Descărcare |
|----------------------|-----|------------|

### CAE data

|                           |     |            |
|---------------------------|-----|------------|
| EPLAN Data Portal 870-826 | URL | Descărcare |
|---------------------------|-----|------------|

|                        |     |            |
|------------------------|-----|------------|
| WSCAD Universe 870-826 | URL | Descărcare |
|------------------------|-----|------------|

## Installation Notes

### Installation

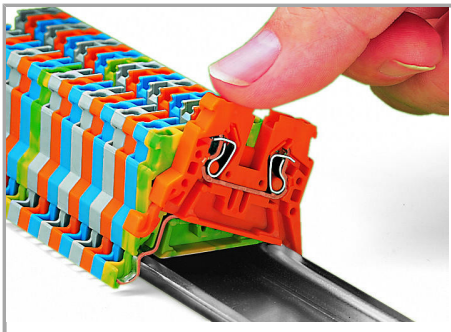

Snapping a rail-mount terminal block onto  
DIN-35 rail.

### Inserting a conductor

Supus modificărilor.

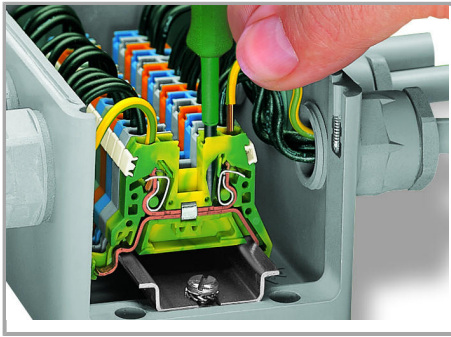

**CAGE CLAMP® connection**

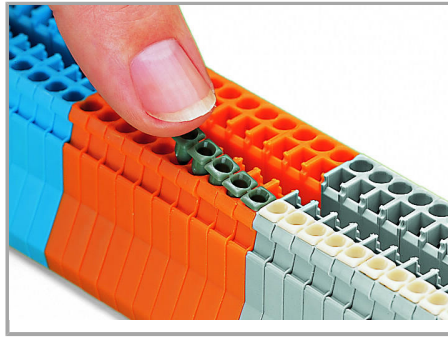

Inserting an insulation stop into conductor entry holes of terminal strip.

Inserting a conductor (0.08 ... 4 mm<sup>2</sup> "f-st").

With ferruled conductors, it is necessary to use a terminal block one size smaller than the conductor's nominal cross section.

#### Marking

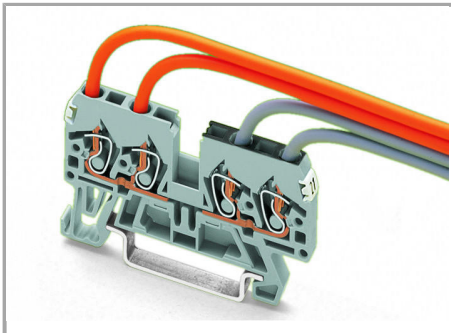

Terminal block marking directly on the terminal block either via Mini-WSB or WMB markers

Supus modificărilor.