

Fișă tehnică | Număr articol: 280-552

Triple-deck terminal block; Through/through/through terminal block; for DIN-rail 35 x 15 and 35 x 7.5; 2.5 mm²; CAGE CLAMP®; 2,50 mm²; gray/gray/blue

www.wago.com/280-552

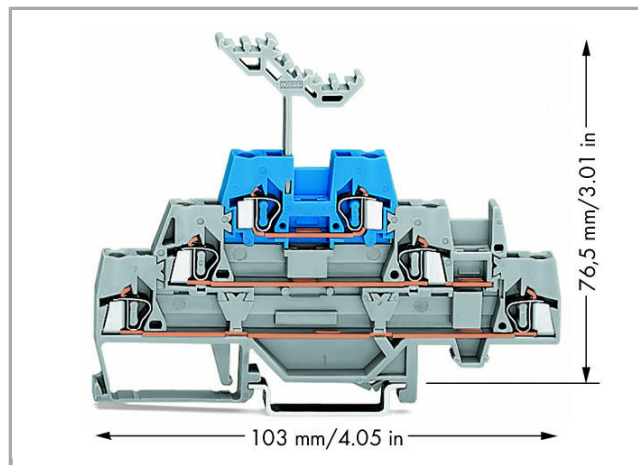
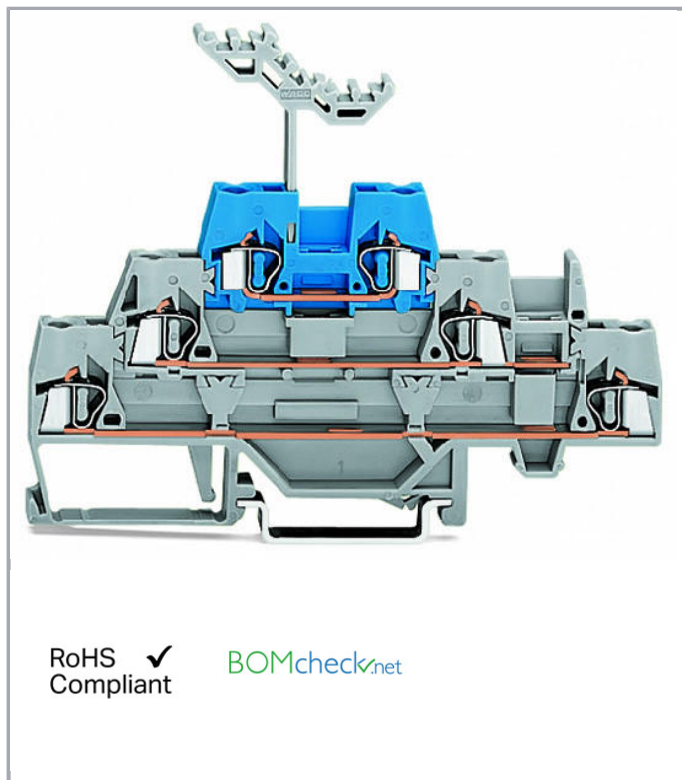

Supus modificărilor.

WAGO Kontakttechnik GmbH & Co. KG
/Representative Office Romania
Sos. Pipera-Tunari nr. 1/1
building 1, 2nd floor | 077190 Voluntari, Ilfov
Tel.: +40-(0)31 421 85 68 | Email: info-RO@wago.com

Aveți întrebări despre produsele noastre?
Vă stăm la dispoziție pentru preluarea apelului la +40 (0) 31 421 85 68.

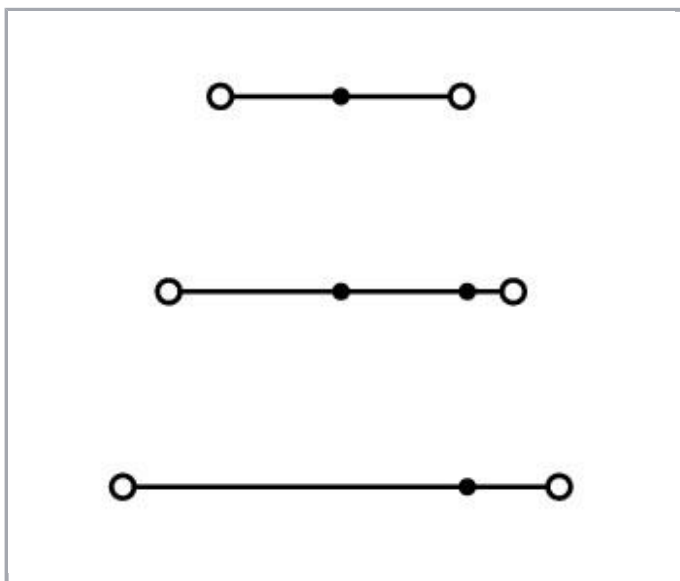

Descriere articol

Note:

Terminating Aluminum Conductors

WAGO spring clamp terminal blocks are suitable for solid aluminum conductors up to 4 mm²/12 AWG if WAGO "Alu-Plus" Contact Paste is used for termination.

"Alu-Plus" Contact Paste Advantages:

- Automatically destroys the oxide film during clamping.
- Prevents fresh oxidation at the clamping point.
- Prevents electrolytic corrosion between aluminum and copper conductors (in the same terminal block).
- Provides long-term protection against corrosion.

Using terminal blocks with CAGE CLAMP® Spring Pressure Connection Technology, **aluminum conductors must first be cleaned with a blade** and then immediately be inserted into the clamping units filled with "Alu-Plus" Contact Paste.

It is also possible to apply WAGO "Alu-Plus" **additionally** on the whole surface of the aluminum conductor before termination.

Please note that the nominal currents must be adapted to the reduced conductivity of the aluminum conductors::

2.5 mm² = 16 A

4 mm² = 22 A

Date

Electrical data

Supus modificărilor.



Ratings per IEC/EN 60664-1

Ratings per	IEC/EN 60947-7-1
Nominal voltage (III/3)	500 V
Rated surge voltage (III/3)	6 kV
Rated current	20 A
Legend (ratings)	(III / 3) ≙ Overvoltage category III / Pollution degree 3

Connection data

Connection technology	CAGE CLAMP®
Actuation type	Operating tool
Connectable conductor materials	Copper Aluminum
Solid conductor	0,08 ... 2,5 mm ² / 28 ... 12 AWG
Fine-stranded conductor	0,08 ... 2,5 mm ² / 28 ... 12 AWG
Strip length	8 ... 9 mm / 0.31 ... 0.35 inch
Total number of connection points	6
Total number of potentials	3
Number of levels	3
Wiring type	Front-entry wiring
Note (conductor cross-section)	12 AWG: THHN, THWN

Geometrical Data

Width	5 mm / 0.197 inch
Height from upper-edge of DIN-rail	76,5 mm / 3.012 inch
Depth	103 mm / 4.055 inch

Mechanical data

Design	horizontal type
Mounting type	DIN-35 rail
Marking level	Center marking

Material Data

Color	gray/gray/blue
Insulation material	Polyamide 66 (PA 66)
Fire load	0,277 MJ
Weight	18,4 g

Supus modificărilor.

WAGO Kontakttechnik GmbH & Co. KG
/Representative Office Romania
Sos. Pipera-Tunari nr. 1/1
building 1, 2nd floor | 077190 Voluntari, Ilfov
Tel.: +40-(0)31 421 85 68 | Email: info-RO@wago.com



Aveți întrebări despre produsele noastre?
Vă stăm la dispoziție pentru preluarea apelului la +40 (0) 31 421 85 68.

Commercial data





Product Group	1 (Rail Mounted Terminal Blocks)
Packaging type	BOX
Country of origin	DE
GTIN	4044918543323
Customs tariff number	85369010000

Aprobări / certificate

Country specific Approvals

Emblemă	Aprobare	Text de aprobare suplimentar	Nume certificat
	CCA DEKRA Certification B.V.	EN 60947	2157201.01
	CSA DEKRA Certification B.V.	C22.2	1536071

Ship Approvals

Emblemă	Aprobare	Text de aprobare suplimentar	Nume certificat
	ABS American Bureau of Shipping	EN 60947	20- HG1941090- PDA
	BV Bureau Veritas S.A.	EN 60947	07436/E0 BV
	DNV GL Det Norske Veritas, Germanischer Lloyd	-	TAE00001V2
	LR Lloyds Register	EN 60947	91/20112 (E9)

UL-Approvals

Supus modificărilor.

WAGO Kontakttechnik GmbH & Co. KG
/Representative Office Romania
Sos. Pipera-Tunari nr. 1/1
building 1, 2nd floor | 077190 Voluntari, Ilfov
Tel.: +40-(0)31 421 85 68 | Email: info-RO@wago.com



Aveți întrebări despre produsele noastre?
Vă stăm la dispoziție pentru preluarea apelului la +40 (0) 31 421 85 68.

Emblemă	Aprobare	Text de aprobare suplimentar	Nume certificat
	UR Underwriters Laboratories Inc.	UL 1059	20190731- E45172





Counterpart

Produse compatibile



















Insulation stop

	Nr. articol: 280-470 Insulation stop; 0.08 - 0.2 mm ² "s" (0.14 mm ² "f-st"); 5 pieces/strip; white	www.wago.com/280-470
	Nr. articol: 280-471 Insulation stop; 0.25 - 0.5 mm ² ; 5 pieces/strip; light gray	www.wago.com/280-471
	Nr. articol: 280-472 Insulation stop; 0.75 - 1 mm ² ; 5 pieces/strip	www.wago.com/280-472

Jumper

	Nr. articol: 210-103 Wire commoning chain; insulated; 50 connections; black	www.wago.com/210-103
	Nr. articol: 210-123 Wire commoning chain; insulated; 50 connections	www.wago.com/210-123
	Nr. articol: 249-123 Push-in type wire jumper; insulated; wire length 180 mm; Conductor cross section 0.75 mm ²	www.wago.com/249-123
	Nr. articol: 249-125 Push-in type wire jumper; insulated; wire length 60 mm; Conductor cross section 0.75 mm ²	www.wago.com/249-125
	Nr. articol: 249-126 Push-in type wire jumper; insulated; wire length 110 mm; Conductor cross section 0.75 mm ²	www.wago.com/249-126













Supus modificărilor.

	Nr. articol: 249-127 Push-in type wire jumper; insulated; wire length 250 mm; Conductor cross section 0.75 mm ²	www.wago.com/249-127
	Nr. articol: 280-402 Adjacent jumper; insulated; IN = IN terminal block; gray	www.wago.com/280-402
	Nr. articol: 280-409 Alternate jumper; insulated; IN = IN terminal block; gray	www.wago.com/280-409
	Nr. articol: 280-482 Comb-style jumper bar; insulated; 2-way; IN = IN terminal block; gray	www.wago.com/280-482
	Nr. articol: 280-483 Comb-style jumper bar; insulated; 3-way; IN = IN terminal block; gray	www.wago.com/280-483
	Nr. articol: 280-484 Comb-style jumper bar; insulated; 4-way; IN = IN terminal block; gray	www.wago.com/280-484
	Nr. articol: 280-485 Comb-style jumper bar; insulated; 5-way; IN = IN terminal block; gray	www.wago.com/280-485
	Nr. articol: 280-490 Comb-style jumper bar; insulated; 10-way; IN = IN terminal block; gray	www.wago.com/280-490
	Nr. articol: 280-492 Alternate comb-style jumper bar; insulated; 2-way; IN = IN terminal block; gray	www.wago.com/280-492
	Nr. articol: 281-421 Vertical jumper; insulated; Nominal current 24 A; gray	www.wago.com/281-421
	Nr. articol: 709-110 Wire commoning chain; insulated; 4 connections; 3 x 110 mm; black	www.wago.com/709-110
	Nr. articol: 709-111 Wire commoning chain; insulated; 3 connections; 2 x 120 mm; black	www.wago.com/709-111
	Nr. articol: 709-112 Wire commoning chain; insulated; 3 connections; 2 x 170 mm; black	www.wago.com/709-112
	Nr. articol: 780-452 Staggered jumper; insulated; from 1 to 2; Spacing: 5 mm; suitable for 2-conductor female plugs; gray	www.wago.com/780-452
	Nr. articol: 780-453 Staggered jumper; insulated; from 1 to 3; Spacing: 5 mm; suitable for 2-conductor female plugs; gray	www.wago.com/780-453
	Nr. articol: 780-454 Staggered jumper; insulated; from 1 to 4; Spacing: 5 mm; suitable for 2-conductor female plugs; gray	www.wago.com/780-454
	Nr. articol: 780-455 Staggered jumper; insulated; from 1 to 5; Spacing: 5 mm; suitable for 2-conductor female plugs; gray	www.wago.com/780-455
	Nr. articol: 780-456 Staggered jumper; insulated; from 1 to 6; Spacing: 5 mm; suitable for 2-conductor female plugs; gray	www.wago.com/780-456

Supus modificărilor.

WAGO Kontakttechnik GmbH & Co. KG
/Representative Office Romania
Sos. Pipera-Tunari nr. 1/1
building 1, 2nd floor | 077190 Voluntari, Ilfov
Tel.: +40-(0)31 421 85 68 | Email: info-RO@wago.com













Aveți întrebări despre produsele noastre?
Vă stăm la dispoziție pentru preluarea apelului la +40 (0) 31 421 85 68.

	Nr. articol: 780-457 Staggered jumper; insulated; from 1 to 7; Spacing: 5 mm; suitable for 2-conductor female plugs; gray	www.wago.com/780-457
	Nr. articol: 780-458 Staggered jumper; insulated; from 1 to 8; Spacing: 5 mm; suitable for 2-conductor female plugs; gray	www.wago.com/780-458
Female plug		
	Nr. articol: 232-132/005-000 Female connector for rail-mount terminal blocks; 0.6 x 1 mm pins; straight; Pin spacing 5 mm; 2-pole; gray	www.wago.com/232-132/005-000
	Nr. articol: 232-132/005-000/039-000 Female connector for rail-mount terminal blocks; 0.6 x 1 mm pins; straight; Locking lever; Pin spacing 5 mm; 2-pole; gray	www.wago.com/232-132/005-000/039-000
	Nr. articol: 232-133/005-000 Female connector for rail-mount terminal blocks; 0.6 x 1 mm pins; straight; Pin spacing 5 mm; 3-pole; gray	www.wago.com/232-133/005-000
	Nr. articol: 232-133/005-000/039-000 Female connector for rail-mount terminal blocks; 0.6 x 1 mm pins; straight; Locking lever; Pin spacing 5 mm; 3-pole; gray	www.wago.com/232-133/005-000/039-000
	Nr. articol: 232-134/005-000 Female connector for rail-mount terminal blocks; 0.6 x 1 mm pins; straight; Pin spacing 5 mm; 4-pole; gray	www.wago.com/232-134/005-000
	Nr. articol: 232-134/005-000/039-000 Female connector for rail-mount terminal blocks; 0.6 x 1 mm pins; straight; Locking lever; Pin spacing 5 mm; 4-pole; gray	www.wago.com/232-134/005-000/039-000
	Nr. articol: 232-135/005-000 Female connector for rail-mount terminal blocks; 0.6 x 1 mm pins; straight; Pin spacing 5 mm; 5-pole; gray	www.wago.com/232-135/005-000
	Nr. articol: 232-135/005-000/039-000 Female connector for rail-mount terminal blocks; 0.6 x 1 mm pins; straight; Locking lever; Pin spacing 5 mm; 5-pole; gray	www.wago.com/232-135/005-000/039-000
	Nr. articol: 232-136/005-000 Female connector for rail-mount terminal blocks; 0.6 x 1 mm pins; straight; Pin spacing 5 mm; 6-pole; gray	www.wago.com/232-136/005-000
	Nr. articol: 232-136/005-000/039-000 Female connector for rail-mount terminal blocks; 0.6 x 1 mm pins; straight; Locking lever; Pin spacing 5 mm; 6-pole; gray	www.wago.com/232-136/005-000/039-000
	Nr. articol: 232-137/005-000 Female connector for rail-mount terminal blocks; 0.6 x 1 mm pins; straight; Pin spacing 5 mm; 7-pole; gray	www.wago.com/232-137/005-000
	Nr. articol: 232-137/005-000/039-000 Female connector for rail-mount terminal blocks; 0.6 x 1 mm pins; straight; Locking lever; Pin spacing	













Supus modificărilor.

WAGO Kontakttechnik GmbH & Co. KG
/Representative Office Romania
Sos. Pipera-Tunari nr. 1/1
building 1, 2nd floor | 077190 Voluntari, Ilfov
Tel.: +40-(0)31 421 85 68 | Email: info-RO@wago.com

Aveți întrebări despre produsele noastre?
Vă stăm la dispoziție pentru preluarea apelului la +40 (0) 31 421 85 68.













	5 mm; 7-pole; gray	www.wago.com/232-137/005-000/039-000
	Nr. articol: 232-138/005-000 Female connector for rail-mount terminal blocks; 0.6 x 1 mm pins; straight; Pin spacing 5 mm; 8-pole; gray	www.wago.com/232-138/005-000
	Nr. articol: 232-138/005-000/039-000 Female connector for rail-mount terminal blocks; 0.6 x 1 mm pins; straight; Locking lever; Pin spacing 5 mm; 8-pole; gray	www.wago.com/232-138/005-000/039-000
	Nr. articol: 232-139/005-000 Female connector for rail-mount terminal blocks; 0.6 x 1 mm pins; straight; Pin spacing 5 mm; 9-pole; gray	www.wago.com/232-139/005-000
	Nr. articol: 232-139/005-000/039-000 Female connector for rail-mount terminal blocks; 0.6 x 1 mm pins; straight; Locking lever; Pin spacing 5 mm; 9-pole; gray	www.wago.com/232-139/005-000/039-000
	Nr. articol: 232-140/005-000 Female connector for rail-mount terminal blocks; 0.6 x 1 mm pins; straight; Pin spacing 5 mm; 10-pole; gray	www.wago.com/232-140/005-000
	Nr. articol: 232-140/005-000/039-000 Female connector for rail-mount terminal blocks; 0.6 x 1 mm pins; straight; Locking lever; Pin spacing 5 mm; 10-pole; gray	www.wago.com/232-140/005-000/039-000
	Nr. articol: 232-142/005-000 Female connector for rail-mount terminal blocks; 0.6 x 1 mm pins; straight; Pin spacing 5 mm; 12-pole; gray	www.wago.com/232-142/005-000
	Nr. articol: 232-142/005-000/039-000 Female connector for rail-mount terminal blocks; 0.6 x 1 mm pins; straight; Locking lever; Pin spacing 5 mm; 12-pole; gray	www.wago.com/232-142/005-000/039-000
	Nr. articol: 232-146/005-000 Female connector for rail-mount terminal blocks; 0.6 x 1 mm pins; straight; Pin spacing 5 mm; 16-pole; gray	www.wago.com/232-146/005-000
	Nr. articol: 232-146/005-000/039-000 Female connector for rail-mount terminal blocks; 0.6 x 1 mm pins; straight; Locking lever; Pin spacing 5 mm; 16-pole; gray	www.wago.com/232-146/005-000/039-000
	Nr. articol: 232-147/005-000/039-000 Female connector for rail-mount terminal blocks; 0.6 x 1 mm pins; straight; Locking lever; Pin spacing 5 mm; 17-pole; gray	www.wago.com/232-147/005-000/039-000
	Nr. articol: 232-150/005-000 Female connector for rail-mount terminal blocks; 0.6 x 1 mm pins; straight; Pin spacing 5 mm; 20-pole; gray	www.wago.com/232-150/005-000
	Nr. articol: 232-150/005-000/039-000	

Supus modificărilor.













	Female connector for rail-mount terminal blocks; 0.6 x 1 mm pins; straight; Locking lever; Pin spacing 5 mm; 20-pole; gray	www.wago.com/232-150/005-000/039-000
	Nr. articol: 232-232/005-000 Female connector for rail-mount terminal blocks; 0.6 x 1 mm pins; angled; Pin spacing 5 mm; 2-pole; gray	www.wago.com/232-232/005-000
	Nr. articol: 232-232/005-000/039-000 Female connector for rail-mount terminal blocks; 0.6 x 1 mm pins; angled; Locking lever; Pin spacing 5 mm; 2-pole; gray	www.wago.com/232-232/005-000/039-000
	Nr. articol: 232-233/005-000 Female connector for rail-mount terminal blocks; 0.6 x 1 mm pins; angled; Pin spacing 5 mm; 3-pole; gray	www.wago.com/232-233/005-000
	Nr. articol: 232-233/005-000/039-000 Female connector for rail-mount terminal blocks; 0.6 x 1 mm pins; angled; Locking lever; Pin spacing 5 mm; 3-pole; gray	www.wago.com/232-233/005-000/039-000
	Nr. articol: 232-234/005-000 Female connector for rail-mount terminal blocks; 0.6 x 1 mm pins; angled; Pin spacing 5 mm; 4-pole; gray	www.wago.com/232-234/005-000
	Nr. articol: 232-234/005-000/039-000 Female connector for rail-mount terminal blocks; 0.6 x 1 mm pins; angled; Locking lever; Pin spacing 5 mm; 4-pole; gray	www.wago.com/232-234/005-000/039-000
	Nr. articol: 232-235/005-000 Female connector for rail-mount terminal blocks; 0.6 x 1 mm pins; angled; Pin spacing 5 mm; 5-pole; gray	www.wago.com/232-235/005-000
	Nr. articol: 232-235/005-000/039-000 Female connector for rail-mount terminal blocks; 0.6 x 1 mm pins; angled; Locking lever; Pin spacing 5 mm; 5-pole; gray	www.wago.com/232-235/005-000/039-000
	Nr. articol: 232-236/005-000 Female connector for rail-mount terminal blocks; 0.6 x 1 mm pins; angled; Pin spacing 5 mm; 6-pole; gray	www.wago.com/232-236/005-000
	Nr. articol: 232-236/005-000/039-000 Female connector for rail-mount terminal blocks; 0.6 x 1 mm pins; angled; Locking lever; Pin spacing 5 mm; 6-pole; gray	www.wago.com/232-236/005-000/039-000
	Nr. articol: 232-237/005-000 Female connector for rail-mount terminal blocks; 0.6 x 1 mm pins; angled; Pin spacing 5 mm; 7-pole; gray	www.wago.com/232-237/005-000
	Nr. articol: 232-238/005-000 Female connector for rail-mount terminal blocks; 0.6 x 1 mm pins; angled; Pin spacing 5 mm; 8-pole; gray	www.wago.com/232-238/005-000

Nr. articol: 232-239/005-000













Supus modificărilor.

	Female connector for rail-mount terminal blocks; 0.6 x 1 mm pins; angled; Pin spacing 5 mm; 9-pole; gray	www.wago.com/232-239/005-000
	Nr. articol: 232-240/005-000 Female connector for rail-mount terminal blocks; 0.6 x 1 mm pins; angled; Pin spacing 5 mm; 10-pole; gray	www.wago.com/232-240/005-000
	Nr. articol: 232-240/005-000/039-000 Female connector for rail-mount terminal blocks; 0.6 x 1 mm pins; angled; Locking lever; Pin spacing 5 mm; 10-pole; gray	www.wago.com/232-240/005-000/039-000
	Nr. articol: 232-242/005-000 Female connector for rail-mount terminal blocks; 0.6 x 1 mm pins; angled; Pin spacing 5 mm; 12-pole; gray	www.wago.com/232-242/005-000
	Nr. articol: 232-242/005-000/039-000 Female connector for rail-mount terminal blocks; 0.6 x 1 mm pins; angled; Locking lever; Pin spacing 5 mm; 12-pole; gray	www.wago.com/232-242/005-000/039-000
	Nr. articol: 232-246/005-000 Female connector for rail-mount terminal blocks; 0.6 x 1 mm pins; angled; Pin spacing 5 mm; 16-pole; gray	www.wago.com/232-246/005-000
	Nr. articol: 232-246/005-000/039-000 Female connector for rail-mount terminal blocks; 0.6 x 1 mm pins; angled; Locking lever; Pin spacing 5 mm; 16-pole; gray	www.wago.com/232-246/005-000/039-000
	Nr. articol: 232-250/005-000 Female connector for rail-mount terminal blocks; 0.6 x 1 mm pins; angled; Pin spacing 5 mm; 20-pole; gray	www.wago.com/232-250/005-000
	Nr. articol: 232-250/005-000/039-000 Female connector for rail-mount terminal blocks; 0.6 x 1 mm pins; angled; Locking lever; Pin spacing 5 mm; 20-pole; gray	www.wago.com/232-250/005-000/039-000
	Nr. articol: 232-732/005-000 THT female header; 0.6 x 1.0 mm solder pin; gray	www.wago.com/232-732/005-000
	Nr. articol: 232-733/005-000 THT female header; 0.6 x 1.0 mm solder pin; gray	www.wago.com/232-733/005-000
	Nr. articol: 232-734/005-000 THT female header; 0.6 x 1.0 mm solder pin; gray	www.wago.com/232-734/005-000
	Nr. articol: 232-734/005-000/039-000 THT female header; 0.6 x 1.0 mm solder pin; gray	www.wago.com/232-734/005-000/039-000













Supus modificărilor.

	Nr. articol: 232-735/005-000 THT female header; 0.6 x 1.0 mm solder pin; gray	www.wago.com/232-735/005-000
	Nr. articol: 232-735/005-000/039-000 THT female header; 0.6 x 1.0 mm solder pin; gray	www.wago.com/232-735/005-000/039-000
	Nr. articol: 232-736/005-000 THT female header; 0.6 x 1.0 mm solder pin; gray	www.wago.com/232-736/005-000
	Nr. articol: 232-736/005-000/039-000 THT female header; 0.6 x 1.0 mm solder pin; gray	www.wago.com/232-736/005-000/039-000
	Nr. articol: 232-738/005-000 THT female header; 0.6 x 1.0 mm solder pin; gray	www.wago.com/232-738/005-000
	Nr. articol: 232-740/005-000 THT female header; 0.6 x 1.0 mm solder pin; gray	www.wago.com/232-740/005-000
	Nr. articol: 232-742/005-000 THT female header; 0.6 x 1.0 mm solder pin; gray	www.wago.com/232-742/005-000
	Nr. articol: 232-832/005-000 THT female header; 0.6 x 1.0 mm solder pin; angled; Pin spacing 7.5 mm; 2-pole; gray	www.wago.com/232-832/005-000
	Nr. articol: 232-833/005-000 THT female header; 0.6 x 1.0 mm solder pin; angled; Pin spacing 7.5 mm; 3-pole; gray	www.wago.com/232-833/005-000
	Nr. articol: 232-834/005-000 THT female header; 0.6 x 1.0 mm solder pin; angled; Pin spacing 7.5 mm; 4-pole; gray	www.wago.com/232-834/005-000
	Nr. articol: 232-836/005-000 THT female header; 0.6 x 1.0 mm solder pin; angled; Pin spacing 7.5 mm; 6-pole; gray	www.wago.com/232-836/005-000
	Nr. articol: 232-836/005-000/039-000 THT female header; 0.6 x 1.0 mm solder pin; angled; Locking lever; Pin spacing 7.5 mm; 6-pole; gray	www.wago.com/232-836/005-000/039-000
	Nr. articol: 232-840/005-000 THT female header; 0.6 x 1.0 mm solder pin; angled; Pin spacing 7.5 mm; 10-pole; gray	www.wago.com/232-840/005-000

Supus modificărilor.

	Nr. articol: 232-842/005-000 THT female header; 0.6 x 1.0 mm solder pin; angled; Pin spacing 7.5 mm; 12-pole; gray	www.wago.com/232-842/005-000
	Nr. articol: 722-132/005-000 Female connector for rail-mount terminal blocks; 0.6 x 1 mm pins; straight; 100% protected against mismatching; Pin spacing 5 mm; 2-pole; light gray	www.wago.com/722-132/005-000
	Nr. articol: 722-132/005-000/039-000 Female connector for rail-mount terminal blocks; 0.6 x 1 mm pins; straight; 100% protected against mismatching; Locking lever; Pin spacing 5 mm; 2-pole; light gray	www.wago.com/722-132/005-000/039-000
	Nr. articol: 722-133/005-000 Female connector for rail-mount terminal blocks; 0.6 x 1 mm pins; straight; 100% protected against mismatching; Pin spacing 5 mm; 3-pole; light gray	www.wago.com/722-133/005-000
	Nr. articol: 722-133/005-000/039-000 Female connector for rail-mount terminal blocks; 0.6 x 1 mm pins; straight; 100% protected against mismatching; Locking lever; Pin spacing 5 mm; 3-pole; light gray	www.wago.com/722-133/005-000/039-000
	Nr. articol: 722-134/005-000 Female connector for rail-mount terminal blocks; 0.6 x 1 mm pins; straight; 100% protected against mismatching; Pin spacing 5 mm; 4-pole; light gray	www.wago.com/722-134/005-000
	Nr. articol: 722-134/005-000/039-000 Female connector for rail-mount terminal blocks; 0.6 x 1 mm pins; straight; 100% protected against mismatching; Locking lever; Pin spacing 5 mm; 4-pole; light gray	www.wago.com/722-134/005-000/039-000
	Nr. articol: 722-135/005-000 Female connector for rail-mount terminal blocks; 0.6 x 1 mm pins; straight; 100% protected against mismatching; Pin spacing 5 mm; 5-pole; light gray	www.wago.com/722-135/005-000
	Nr. articol: 722-135/005-000/039-000 Female connector for rail-mount terminal blocks; 0.6 x 1 mm pins; straight; 100% protected against mismatching; Locking lever; Pin spacing 5 mm; 5-pole; light gray	www.wago.com/722-135/005-000/039-000
	Nr. articol: 722-136/005-000 Female connector for rail-mount terminal blocks; 0.6 x 1 mm pins; straight; 100% protected against mismatching; Pin spacing 5 mm; 6-pole; light gray	www.wago.com/722-136/005-000
	Nr. articol: 722-136/005-000/039-000 Female connector for rail-mount terminal blocks; 0.6 x 1 mm pins; straight; 100% protected against mismatching; Locking lever; Pin spacing 5 mm; 6-pole; light gray	www.wago.com/722-136/005-000/039-000
	Nr. articol: 722-137/005-000 Female connector for rail-mount terminal blocks; 0.6 x 1 mm pins; straight; 100% protected against mismatching; Pin spacing 5 mm; 7-pole; light gray	www.wago.com/722-137/005-000
	Nr. articol: 722-137/005-000/039-000 Female connector for rail-mount terminal blocks; 0.6 x 1 mm pins; straight; 100% protected against mismatching; Locking lever; Pin spacing 5 mm; 7-pole; light gray	www.wago.com/722-137/005-000/039-000
	Nr. articol: 722-138/005-000	

Supus modificărilor.

	Female connector for rail-mount terminal blocks; 0.6 x 1 mm pins; straight; 100% protected against mismatching; Pin spacing 5 mm; 8-pole; light gray	www.wago.com/722-138/005-000
	Nr. articol: 722-138/005-000/039-000 Female connector for rail-mount terminal blocks; 0.6 x 1 mm pins; straight; 100% protected against mismatching; Locking lever; Pin spacing 5 mm; 8-pole; light gray	www.wago.com/722-138/005-000/039-000
	Nr. articol: 722-139/005-000 Female connector for rail-mount terminal blocks; 0.6 x 1 mm pins; straight; 100% protected against mismatching; Pin spacing 5 mm; 9-pole; light gray	www.wago.com/722-139/005-000
	Nr. articol: 722-139/005-000/039-000 Female connector for rail-mount terminal blocks; 0.6 x 1 mm pins; straight; 100% protected against mismatching; Locking lever; Pin spacing 5 mm; 9-pole; light gray	www.wago.com/722-139/005-000/039-000
	Nr. articol: 722-140/005-000 Female connector for rail-mount terminal blocks; 0.6 x 1 mm pins; straight; 100% protected against mismatching; Pin spacing 5 mm; 10-pole; light gray	www.wago.com/722-140/005-000
	Nr. articol: 722-140/005-000/039-000 Female connector for rail-mount terminal blocks; 0.6 x 1 mm pins; straight; 100% protected against mismatching; Locking lever; Pin spacing 5 mm; 10-pole; light gray	www.wago.com/722-140/005-000/039-000
	Nr. articol: 722-141/005-000 Female connector for rail-mount terminal blocks; 0.6 x 1 mm pins; straight; 100% protected against mismatching; Pin spacing 5 mm; 11-pole; light gray	www.wago.com/722-141/005-000
	Nr. articol: 722-142/005-000 Female connector for rail-mount terminal blocks; 0.6 x 1 mm pins; straight; 100% protected against mismatching; Pin spacing 5 mm; 12-pole; light gray	www.wago.com/722-142/005-000
	Nr. articol: 722-142/005-007/039-000 Female connector for rail-mount terminal blocks; gray	www.wago.com/722-142/005-007/039-000
	Nr. articol: 722-143/005-000 Female connector for rail-mount terminal blocks; 0.6 x 1 mm pins; straight; 100% protected against mismatching; Pin spacing 5 mm; 13-pole; light gray	www.wago.com/722-143/005-000
	Nr. articol: 722-144/005-000 Female connector for rail-mount terminal blocks; 0.6 x 1 mm pins; straight; 100% protected against mismatching; Pin spacing 5 mm; 14-pole; light gray	www.wago.com/722-144/005-000
	Nr. articol: 722-144/005-000/039-000 Female connector for rail-mount terminal blocks; 0.6 x 1 mm pins; straight; 100% protected against mismatching; Locking lever; Pin spacing 5 mm; 14-pole; light gray	www.wago.com/722-144/005-000/039-000
	Nr. articol: 722-145/005-000 Female connector for rail-mount terminal blocks; 0.6 x 1 mm pins; straight; 100% protected against mismatching; Pin spacing 5 mm; 15-pole; light gray	www.wago.com/722-145/005-000

Nr. articol: 722-146/005-000

Supus modificărilor.

WAGO Kontakttechnik GmbH & Co. KG
/Representative Office Romania
Sos. Pipera-Tunari nr. 1/1
building 1, 2nd floor | 077190 Voluntari, Ilfov
Tel.: +40-(0)31 421 85 68 | Email: info-RO@wago.com

Aveți întrebări despre produsele noastre?
Vă stăm la dispoziție pentru preluarea apelului la +40 (0) 31 421 85 68.



Female connector for rail-mount terminal blocks; 0.6 x 1 mm pins; straight; 100% protected against mismatching; Pin spacing 5 mm; 16-pole; light gray

www.wago.com/722-146/005-000

Nr. articol: 722-146/005-000/039-000

Female connector for rail-mount terminal blocks; 0.6 x 1 mm pins; straight; 100% protected against mismatching; Locking lever; Pin spacing 5 mm; 16-pole; light gray

www.wago.com/722-146/005-000/039-000

Nr. articol: 722-150/005-000

Female connector for rail-mount terminal blocks; 0.6 x 1 mm pins; straight; 100% protected against mismatching; Pin spacing 5 mm; 20-pole; light gray

www.wago.com/722-150/005-000

Nr. articol: 722-150/005-000/039-000

Female connector for rail-mount terminal blocks; 0.6 x 1 mm pins; straight; 100% protected against mismatching; Locking lever; Pin spacing 5 mm; 20-pole; light gray

www.wago.com/722-150/005-000/039-000

Nr. articol: 722-232/005-000

Female connector for rail-mount terminal blocks; 0.6 x 1 mm pins; angled; 100% protected against mismatching; Pin spacing 5 mm; 2-pole; light gray

www.wago.com/722-232/005-000

Nr. articol: 722-232/005-000/039-000

Female connector for rail-mount terminal blocks; 0.6 x 1 mm pins; angled; 100% protected against mismatching; Locking lever; Pin spacing 5 mm; 2-pole; light gray

www.wago.com/722-232/005-000/039-000

Nr. articol: 722-233/005-000

Female connector for rail-mount terminal blocks; 0.6 x 1 mm pins; angled; 100% protected against mismatching; Pin spacing 5 mm; 3-pole; light gray

www.wago.com/722-233/005-000

Nr. articol: 722-233/005-000/039-000

Female connector for rail-mount terminal blocks; 0.6 x 1 mm pins; angled; 100% protected against mismatching; Locking lever; Pin spacing 5 mm; 3-pole; light gray

www.wago.com/722-233/005-000/039-000

Nr. articol: 722-234/005-000

Female connector for rail-mount terminal blocks; 0.6 x 1 mm pins; angled; 100% protected against mismatching; Pin spacing 5 mm; 4-pole; light gray

www.wago.com/722-234/005-000

Nr. articol: 722-234/005-000/039-000

Female connector for rail-mount terminal blocks; 0.6 x 1 mm pins; angled; 100% protected against mismatching; Locking lever; Pin spacing 5 mm; 4-pole; light gray

www.wago.com/722-234/005-000/039-000

Nr. articol: 722-235/005-000

Female connector for rail-mount terminal blocks; 0.6 x 1 mm pins; angled; 100% protected against mismatching; Pin spacing 5 mm; 5-pole; light gray

www.wago.com/722-235/005-000

Nr. articol: 722-235/005-000/039-000

Female connector for rail-mount terminal blocks; 0.6 x 1 mm pins; angled; 100% protected against mismatching; Locking lever; Pin spacing 5 mm; 5-pole; light gray

www.wago.com/722-235/005-000/039-000

Nr. articol: 722-236/005-000

Female connector for rail-mount terminal blocks; 0.6 x 1 mm pins; angled; 100% protected against mismatching; Pin spacing 5 mm; 6-pole; light gray













www.wago.com/722-236/005-000

Nr. articol: 722-236/005-000/039-000

Supra modificărilor.

WAGO Kontakttechnik GmbH & Co. KG
/Representative Office Romania
Sos. Pipera-Tunari nr. 1/1
building 1, 2nd floor | 077190 Voluntari, Ilfov
Tel.: +40-(0)31 421 85 68 | Email: info-RO@wago.com

Aveți întrebări despre produsele noastre?
Vă stăm la dispoziție pentru preluarea apelului la +40 (0) 31 421 85 68.

	Female connector for rail-mount terminal blocks; 0.6 x 1 mm pins; angled; 100% protected against mismatching; Locking lever; Pin spacing 5 mm; 6-pole; light gray	www.wago.com/722-236/005-000/039-000
	Nr. articol: 722-237/005-000 Female connector for rail-mount terminal blocks; 0.6 x 1 mm pins; angled; 100% protected against mismatching; Pin spacing 5 mm; 7-pole; light gray	www.wago.com/722-237/005-000
	Nr. articol: 722-237/005-000/039-000 Female connector for rail-mount terminal blocks; 0.6 x 1 mm pins; angled; 100% protected against mismatching; Locking lever; Pin spacing 5 mm; 7-pole; light gray	www.wago.com/722-237/005-000/039-000
	Nr. articol: 722-238/005-000 Female connector for rail-mount terminal blocks; 0.6 x 1 mm pins; angled; 100% protected against mismatching; Pin spacing 5 mm; 8-pole; light gray	www.wago.com/722-238/005-000
	Nr. articol: 722-239/005-000 Female connector for rail-mount terminal blocks; 0.6 x 1 mm pins; angled; 100% protected against mismatching; Pin spacing 5 mm; 9-pole; light gray	www.wago.com/722-239/005-000
	Nr. articol: 722-239/005-000/039-000 Female connector for rail-mount terminal blocks; 0.6 x 1 mm pins; angled; 100% protected against mismatching; Locking lever; Pin spacing 5 mm; 9-pole; light gray	www.wago.com/722-239/005-000/039-000
	Nr. articol: 722-240/005-000 Female connector for rail-mount terminal blocks; 0.6 x 1 mm pins; angled; 100% protected against mismatching; Pin spacing 5 mm; 10-pole; light gray	www.wago.com/722-240/005-000
	Nr. articol: 722-240/005-000/039-000 Female connector for rail-mount terminal blocks; 0.6 x 1 mm pins; angled; 100% protected against mismatching; Locking lever; Pin spacing 5 mm; 10-pole; light gray	www.wago.com/722-240/005-000/039-000
	Nr. articol: 722-241/005-000 Female connector for rail-mount terminal blocks; 0.6 x 1 mm pins; angled; 100% protected against mismatching; Pin spacing 5 mm; 11-pole; light gray	www.wago.com/722-241/005-000
	Nr. articol: 722-242/005-000 Female connector for rail-mount terminal blocks; 0.6 x 1 mm pins; angled; 100% protected against mismatching; Pin spacing 5 mm; 12-pole; light gray	www.wago.com/722-242/005-000
	Nr. articol: 722-242/005-000/039-000 Female connector for rail-mount terminal blocks; 0.6 x 1 mm pins; angled; 100% protected against mismatching; Locking lever; Pin spacing 5 mm; 12-pole; light gray	www.wago.com/722-242/005-000/039-000
	Nr. articol: 722-243/005-000 Female connector for rail-mount terminal blocks; 0.6 x 1 mm pins; angled; 100% protected against mismatching; Pin spacing 5 mm; 13-pole; light gray	www.wago.com/722-243/005-000
	Nr. articol: 722-244/005-000 Female connector for rail-mount terminal blocks; 0.6 x 1 mm pins; angled; 100% protected against mismatching; Pin spacing 5 mm; 14-pole; light gray	www.wago.com/722-244/005-000

Nr. articol: 722-244/005-000/039-000

Supus modificărilor.

WAGO Kontakttechnik GmbH & Co. KG
/Representative Office Romania
Sos. Pipera-Tunari nr. 1/1
building 1, 2nd floor | 077190 Voluntari, Ilfov
Tel.: +40-(0)31 421 85 68 | Email: info-RO@wago.com

Aveți întrebări despre produsele noastre?
Vă stăm la dispoziție pentru preluarea apelului la +40 (0) 31 421 85 68.



Female connector for rail-mount terminal blocks; 0.6 x 1 mm pins; angled; 100% protected against mismatching; Locking lever; Pin spacing 5 mm; 14-pole; light gray

www.wago.com/722-244/005-000/039-000



Nr. articol: 722-246/005-000

Female connector for rail-mount terminal blocks; 0.6 x 1 mm pins; angled; 100% protected against mismatching; Pin spacing 5 mm; 16-pole; light gray

www.wago.com/722-246/005-000



Nr. articol: 722-246/005-000/039-000

Female connector for rail-mount terminal blocks; 0.6 x 1 mm pins; angled; 100% protected against mismatching; Locking lever; Pin spacing 5 mm; 16-pole; light gray

www.wago.com/722-246/005-000/039-000



Nr. articol: 722-250/005-000

Female connector for rail-mount terminal blocks; 0.6 x 1 mm pins; angled; 100% protected against mismatching; Pin spacing 5 mm; 20-pole; light gray

www.wago.com/722-250/005-000

Protective Warning Marker



Nr. articol: 280-415

Protective warning marker; with high-voltage symbol, black; for 5 terminal blocks; yellow

www.wago.com/280-415

tools



Nr. articol: 210-657

Operating tool; Blade: 3.5 x 0.5 mm; with a partially insulated shaft; short

www.wago.com/210-657



Nr. articol: 210-658

Operating tool; Blade: 3.5 x 0.5 mm; with a partially insulated shaft; angled; short

www.wago.com/210-658



Nr. articol: 210-720

Operating tool; Blade: 3.5 x 0.5 mm; with a partially insulated shaft

www.wago.com/210-720

assembling



Nr. articol: 209-106

Mounting carrier; for isolated mounting on DIN 35 rails; gray

www.wago.com/209-106



Nr. articol: 709-154

Cover; Type 2; suitable for cover carrier, type 2; 1 m long; transparent

www.wago.com/709-154

check



Nr. articol: 249-141

L-type test plug module; modular; with spring-loaded contact pin; Center module; 1,50 mm²; gray

www.wago.com/249-141

ferrule



Nr. articol: 216-101

Ferrule; Sleeve for 0.5 mm² / AWG 22; uninsulated; electro-tin plated

www.wago.com/216-101



Nr. articol: 216-102

Ferrule; Sleeve for 0.75 mm² / AWG 20; uninsulated; electro-tin plated

www.wago.com/216-102

















Nr. articol: 216-103

Ferrule; Sleeve for 1 mm² / AWG 18; uninsulated; electro-tin plated

www.wago.com/216-103















Supus modificărilor.

	Nr. articol: 216-104 Ferrule; Sleeve for 1.5 mm ² / AWG 16; uninsulated; electro-tin plated	www.wago.com/216-104
	Nr. articol: 216-201 Ferrule; Sleeve for 0.5 mm ² / 20 AWG; insulated; electro-tin plated; white	www.wago.com/216-201
	Nr. articol: 216-202 Ferrule; Sleeve for 0.75 mm ² / 18 AWG; insulated; electro-tin plated; gray	www.wago.com/216-202
	Nr. articol: 216-203 Ferrule; Sleeve for 1 mm ² / AWG 18; insulated; electro-tin plated; red	www.wago.com/216-203
	Nr. articol: 216-204 Ferrule; Sleeve for 1.5 mm ² / AWG 16; insulated; electro-tin plated; black	www.wago.com/216-204
	Nr. articol: 216-301 Ferrule; Sleeve for 0.25 mm ² / AWG 24; insulated; electro-tin plated; yellow	www.wago.com/216-301
	Nr. articol: 216-302 Ferrule; Sleeve for 0.34 mm ² / 22 AWG; insulated; electro-tin plated; green	www.wago.com/216-302
General accessories		
	Nr. articol: 231-162/003-000 Male connector for rail-mount terminal blocks; 1.2 x 1.2 mm pins; straight; Pin spacing 5 mm; 2-pole; gray	www.wago.com/231-162/003-000
	Nr. articol: 231-163/003-000 Male connector for rail-mount terminal blocks; 1.2 x 1.2 mm pins; straight; Pin spacing 5 mm; 3-pole; gray	www.wago.com/231-163/003-000
	Nr. articol: 231-164/003-000 Male connector for rail-mount terminal blocks; 1.2 x 1.2 mm pins; straight; Pin spacing 5 mm; 4-pole; gray	www.wago.com/231-164/003-000
	Nr. articol: 231-165/003-000 Male connector for rail-mount terminal blocks; 1.2 x 1.2 mm pins; straight; Pin spacing 5 mm; 5-pole; gray	www.wago.com/231-165/003-000
	Nr. articol: 231-166/003-000 Male connector for rail-mount terminal blocks; 1.2 x 1.2 mm pins; straight; Pin spacing 5 mm; 6-pole; gray	www.wago.com/231-166/003-000
	Nr. articol: 231-167/003-000 Male connector for rail-mount terminal blocks; 1.2 x 1.2 mm pins; straight; Pin spacing 5 mm; 7-pole; gray	www.wago.com/231-167/003-000
	Nr. articol: 231-168/003-000 Male connector for rail-mount terminal blocks; 1.2 x 1.2 mm pins; straight; Pin spacing 5 mm; 8-pole; gray	www.wago.com/231-168/003-000
	Nr. articol: 231-169/003-000 Male connector for rail-mount terminal blocks; 1.2 x 1.2 mm pins; straight; Pin spacing 5 mm; 9-pole; gray	www.wago.com/231-169/003-000

Supus modificărilor.

WAGO Kontakttechnik GmbH & Co. KG
/Representative Office Romania
Sos. Pipera-Tunari nr. 1/1
building 1, 2nd floor | 077190 Voluntari, Ilfov
Tel.: +40-(0)31 421 85 68 | Email: info-RO@wago.com















Aveți întrebări despre produsele noastre?
Vă stăm la dispoziție pentru preluarea apelului la +40 (0) 31 421 85 68.

	Nr. articol: 231-170/003-000 Male connector for rail-mount terminal blocks; 1.2 x 1.2 mm pins; straight; Pin spacing 5 mm; 10-pole; gray	www.wago.com/231-170/003-000
	Nr. articol: 231-171/003-000 Male connector for rail-mount terminal blocks; 1.2 x 1.2 mm pins; straight; Pin spacing 5 mm; 11-pole; gray	www.wago.com/231-171/003-000
	Nr. articol: 231-172/003-000 Male connector for rail-mount terminal blocks; 1.2 x 1.2 mm pins; straight; Pin spacing 5 mm; 12-pole; gray	www.wago.com/231-172/003-000
	Nr. articol: 231-176/003-000 Male connector for rail-mount terminal blocks; 1.2 x 1.2 mm pins; straight; Pin spacing 5 mm; 16-pole; gray	www.wago.com/231-176/003-000
	Nr. articol: 231-180/003-000 Male connector for rail-mount terminal blocks; 1.2 x 1.2 mm pins; straight; Pin spacing 5 mm; 20-pole; gray	www.wago.com/231-180/003-000
	Nr. articol: 231-668 Lockout caps; for covering unused clamping units; gray	www.wago.com/231-668
	Nr. articol: 231-669 Lockout caps; for covering unused clamping units; orange	www.wago.com/231-669
	Nr. articol: 721-162/003-000 Male connector for rail-mount terminal blocks; 1.2 x 1.2 mm pins; straight; 100% protected against mismatching; Pin spacing 5 mm; 2-pole; light gray	www.wago.com/721-162/003-000
	Nr. articol: 721-163/003-000 Male connector for rail-mount terminal blocks; 1.2 x 1.2 mm pins; straight; 100% protected against mismatching; Pin spacing 5 mm; 3-pole; light gray	www.wago.com/721-163/003-000
	Nr. articol: 721-164/003-000 Male connector for rail-mount terminal blocks; 1.2 x 1.2 mm pins; straight; 100% protected against mismatching; Pin spacing 5 mm; 4-pole; light gray	www.wago.com/721-164/003-000
	Nr. articol: 721-165/003-000 Male connector for rail-mount terminal blocks; 1.2 x 1.2 mm pins; straight; 100% protected against mismatching; Pin spacing 5 mm; 5-pole; light gray	www.wago.com/721-165/003-000
	Nr. articol: 721-166/003-000 Male connector for rail-mount terminal blocks; 1.2 x 1.2 mm pins; straight; 100% protected against mismatching; Pin spacing 5 mm; 6-pole; light gray	www.wago.com/721-166/003-000
	Nr. articol: 721-167/003-000 Male connector for rail-mount terminal blocks; 1.2 x 1.2 mm pins; straight; 100% protected against mismatching; Pin spacing 5 mm; 7-pole; light gray	www.wago.com/721-167/003-000
	Nr. articol: 721-168/003-000 Male connector for rail-mount terminal blocks; 1.2 x 1.2 mm pins; straight; 100% protected against mismatching; Pin spacing 5 mm; 8-pole; light gray	www.wago.com/721-168/003-000















Supus modificărilor.

WAGO Kontakttechnik GmbH & Co. KG
/Representative Office Romania
Sos. Pipera-Tunari nr. 1/1
building 1, 2nd floor | 077190 Voluntari, Ilfov
Tel.: +40-(0)31 421 85 68 | Email: info-RO@wago.com

Aveți întrebări despre produsele noastre?
Vă stăm la dispoziție pentru preluarea apelului la +40 (0) 31 421 85 68.

	Nr. articol: 721-169/003-000 Male connector for rail-mount terminal blocks; 1.2 x 1.2 mm pins; straight; 100% protected against mismatching; Pin spacing 5 mm; 9-pole; light gray	www.wago.com/721-169/003-000
	Nr. articol: 721-170/003-000 Male connector for rail-mount terminal blocks; 1.2 x 1.2 mm pins; straight; 100% protected against mismatching; Pin spacing 5 mm; 10-pole; light gray	www.wago.com/721-170/003-000
	Nr. articol: 721-171/003-000 Male connector for rail-mount terminal blocks; 1.2 x 1.2 mm pins; straight; 100% protected against mismatching; Pin spacing 5 mm; 11-pole; light gray	www.wago.com/721-171/003-000
	Nr. articol: 721-172/003-000 Male connector for rail-mount terminal blocks; 1.2 x 1.2 mm pins; straight; 100% protected against mismatching; Pin spacing 5 mm; 12-pole; light gray	www.wago.com/721-172/003-000
	Nr. articol: 721-173/003-000 Male connector for rail-mount terminal blocks; 1.2 x 1.2 mm pins; straight; 100% protected against mismatching; Pin spacing 5 mm; 13-pole; light gray	www.wago.com/721-173/003-000
	Nr. articol: 721-174/003-000 Male connector for rail-mount terminal blocks; 1.2 x 1.2 mm pins; straight; 100% protected against mismatching; Pin spacing 5 mm; 14-pole; light gray	www.wago.com/721-174/003-000
	Nr. articol: 721-175/003-000 Male connector for rail-mount terminal blocks; 1.2 x 1.2 mm pins; straight; 100% protected against mismatching; Pin spacing 5 mm; 15-pole; light gray	www.wago.com/721-175/003-000
	Nr. articol: 721-176/003-000 Male connector for rail-mount terminal blocks; 1.2 x 1.2 mm pins; straight; 100% protected against mismatching; Pin spacing 5 mm; 16-pole; light gray	www.wago.com/721-176/003-000
	Nr. articol: 721-180/003-000 Male connector for rail-mount terminal blocks; 1.2 x 1.2 mm pins; straight; 100% protected against mismatching; Pin spacing 5 mm; 20-pole; light gray	www.wago.com/721-180/003-000
Carrier rail		
	Nr. articol: 210-112 Steel carrier rail; 35 x 7.5 mm; 1 mm thick; 2 m long; slotted; according to EN 60715; "Hole width 25 mm	www.wago.com/210-112
	Nr. articol: 210-113 Steel carrier rail; 35 x 7.5 mm; 1 mm thick; 2 m long; unslotted; according to EN 60715	www.wago.com/210-113
	Nr. articol: 210-114 Steel carrier rail; 35 x 15 mm; 1.5 mm thick; 2 m long; unslotted; similar to EN 60715	www.wago.com/210-114
	Nr. articol: 210-115 Steel carrier rail; 35 x 7.5 mm; 1 mm thick; 2 m long; slotted; according to EN 60715; "Hole width 18 mm	www.wago.com/210-115
	Nr. articol: 210-118 Steel carrier rail; 35 x 15 mm; 2.3 mm thick; 2 m long; unslotted; according to EN 60715	www.wago.com/210-118
Nr. articol: 210-196		















Supus modificărilor.

	Aluminum carrier rail; 35 x 8.2 mm; 1.6 mm thick; 2 m long; unslotted; similar to EN 60715; silver-colored	www.wago.com/210-196
	Nr. articol: 210-197 Steel carrier rail; 35 x 15 mm; 1.5 mm thick; 2 m long; slotted; similar to EN 60715	www.wago.com/210-197
	Nr. articol: 210-198 Copper carrier rail; 35 x 15 mm; 2.3 mm thick; 2 m long; unslotted; according to EN 60715; copper-colored	www.wago.com/210-198
	Nr. articol: 210-504 Steel carrier rail; 35 x 7.5 mm; 1 mm thick; 2 m long; slotted; galvanized; according to EN 60715	www.wago.com/210-504
	Nr. articol: 210-505 Steel carrier rail; 35 x 7.5 mm; 1 mm thick; 2 m long; unslotted; galvanized; according to EN 60715	www.wago.com/210-505
	Nr. articol: 210-506 Steel carrier rail; 35 x 15 mm; 1.5 mm thick; 2 m long; unslotted; galvanized; similar to EN 60715	www.wago.com/210-506
	Nr. articol: 210-508 Steel carrier rail; 35 x 15 mm; 1.5 mm thick; 2 m long; slotted; galvanized; similar to EN 60715	www.wago.com/210-508
Marking accessories		
	Nr. articol: 2009-115 WMB-Inline; for Smart Printer; 1500 pieces on roll; stretchable 5 - 5.2 mm; plain; snap-on type; white	www.wago.com/2009-115
	Nr. articol: 2009-115/000-002 WMB-Inline; for Smart Printer; 1500 pieces on roll; stretchable 5 - 5.2 mm; plain; snap-on type; yellow	www.wago.com/2009-115/000-002
	Nr. articol: 2009-115/000-006 WMB-Inline; for Smart Printer; 1500 pieces on roll; stretchable 5 - 5.2 mm; plain; snap-on type; blue	www.wago.com/2009-115/000-006
	Nr. articol: 2009-115/000-007 WMB-Inline; for Smart Printer; 1500 pieces on roll; stretchable 5 - 5.2 mm; plain; snap-on type; gray	www.wago.com/2009-115/000-007
	Nr. articol: 2009-115/000-012 WMB-Inline; for Smart Printer; 1500 pieces on roll; stretchable 5 - 5.2 mm; plain; snap-on type; orange	www.wago.com/2009-115/000-012
	Nr. articol: 2009-115/000-017 WMB-Inline; for Smart Printer; 1500 pieces on roll; stretchable 5 - 5.2 mm; plain; snap-on type; light green	www.wago.com/2009-115/000-017
	Nr. articol: 2009-115/000-023 WMB-Inline; for Smart Printer; 1500 pieces on roll; stretchable 5 - 5.2 mm; plain; snap-on type; green	www.wago.com/2009-115/000-023
	Nr. articol: 2009-115/000-024 WMB-Inline; for Smart Printer; 1500 pieces on roll; stretchable 5 - 5.2 mm; plain; snap-on type; violet	www.wago.com/2009-115/000-024







Supus modificărilor.

WAGO Kontakttechnik GmbH & Co. KG
/Representative Office Romania
Sos. Pipera-Tunari nr. 1/1
building 1, 2nd floor | 077190 Voluntari, Ilfov
Tel.: +40-(0)31 421 85 68 | Email: info-RO@wago.com

Aveți întrebări despre produsele noastre?
Vă stăm la dispoziție pentru preluarea apelului la +40 (0) 31 421 85 68.

	Nr. articol: 793-501 WMB marking card; as card; not stretchable; plain; snap-on type; white	www.wago.com/793-501
	Nr. articol: 793-501/000-002 WMB marking card; as card; not stretchable; plain; snap-on type; yellow	www.wago.com/793-501/000-002
	Nr. articol: 793-501/000-005 WMB marking card; as card; not stretchable; plain; snap-on type; red	www.wago.com/793-501/000-005
	Nr. articol: 793-501/000-006 WMB marking card; as card; not stretchable; plain; snap-on type; blue	www.wago.com/793-501/000-006
	Nr. articol: 793-501/000-007 WMB marking card; as card; not stretchable; plain; snap-on type; gray	www.wago.com/793-501/000-007
	Nr. articol: 793-501/000-012 WMB marking card; as card; not stretchable; plain; snap-on type; orange	www.wago.com/793-501/000-012
	Nr. articol: 793-501/000-017 WMB marking card; as card; not stretchable; plain; snap-on type; light green	www.wago.com/793-501/000-017
	Nr. articol: 793-501/000-023 WMB marking card; as card; not stretchable; plain; snap-on type; green	www.wago.com/793-501/000-023
	Nr. articol: 793-501/000-024 WMB marking card; as card; not stretchable; plain; snap-on type; violet	www.wago.com/793-501/000-024
	Nr. articol: 793-5501 WMB marking card; as card; for terminal block width 5 - 17.5 mm; stretchable 5 - 5.2 mm; plain; snap-on type; white	www.wago.com/793-5501
	Nr. articol: 793-5501/000-002 WMB marking card; as card; for terminal block width 5 - 17.5 mm; stretchable 5 - 5.2 mm; plain; snap-on type; yellow	www.wago.com/793-5501/000-002
	Nr. articol: 793-5501/000-005 WMB marking card; as card; for terminal block width 5 - 17.5 mm; stretchable 5 - 5.2 mm; plain; snap-on type; red	www.wago.com/793-5501/000-005
	Nr. articol: 793-5501/000-006 WMB marking card; as card; for terminal block width 5 - 17.5 mm; stretchable 5 - 5.2 mm; plain; snap-on type; blue	www.wago.com/793-5501/000-006
	Nr. articol: 793-5501/000-007 WMB marking card; as card; for terminal block width 5 - 17.5 mm; stretchable 5 - 5.2 mm; plain; snap-on type; gray	www.wago.com/793-5501/000-007

Supus modificărilor.

	Nr. articol: 793-5501/000-012 WMB marking card; as card; for terminal block width 5 - 17.5 mm; stretchable 5 - 5.2 mm; plain; snap-on type; orange	www.wago.com/793-5501/000-012
	Nr. articol: 793-5501/000-017 WMB marking card; as card; for terminal block width 5 - 17.5 mm; stretchable 5 - 5.2 mm; plain; snap-on type; green	www.wago.com/793-5501/000-017
	Nr. articol: 793-5501/000-023 WMB marking card; as card; for terminal block width 5 - 17.5 mm; stretchable 5 - 5.2 mm; plain; snap-on type; light green	www.wago.com/793-5501/000-023
	Nr. articol: 793-5501/000-024 WMB marking card; as card; for terminal block width 5 - 17.5 mm; stretchable 5 - 5.2 mm; plain; snap-on type; violet	www.wago.com/793-5501/000-024
End plate		
	Nr. articol: 280-303 End and intermediate plate; 2.5 mm thick; gray	www.wago.com/280-303
	Nr. articol: 280-304 End and intermediate plate; 2.5 mm thick; orange	www.wago.com/280-304
	Nr. articol: 280-336 Intermediate plate; 1.1 mm thick; orange	www.wago.com/280-336

Descărcări

Documentation

Additional Information

Technical explanations	Apr 3, 2019	pdf 2,1 MB	Descărcare
------------------------	-------------	---------------	------------

CAD/CAE-Data

CAD data

2D/3D Models 280-552	URL	Descărcare
----------------------	-----	------------

CAE data

EPLAN Data Portal 280-552	URL	Descărcare
---------------------------	-----	------------

WSCAD Universe 280-552	URL	Descărcare
------------------------	-----	------------

Supus modificărilor.

WAGO Kontakttechnik GmbH & Co. KG
/Representative Office Romania
Sos. Pipera-Tunari nr. 1/1
building 1, 2nd floor | 077190 Voluntari, Ilfov
Tel.: +40-(0)31 421 85 68 | Email: info-RO@wago.com

Aveți întrebări despre produsele noastre?
Vă stăm la dispoziție pentru preluarea apelului la +40 (0) 31 421 85 68.

Installation Notes

Assembly

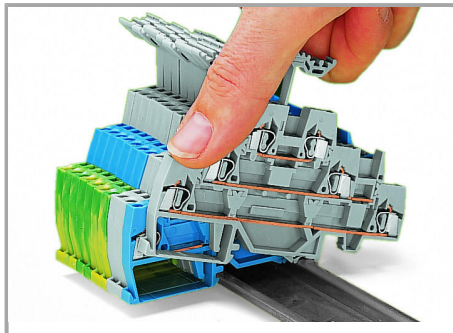

Snapping a terminal block onto the carrier rail.

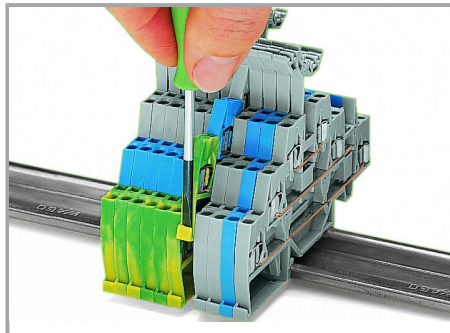

Removing a terminal block from the assembly.

Inserting a conductor

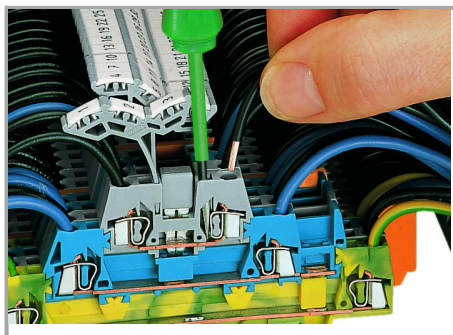

CAGE CLAMP® connection

Inserting a conductor.

When using ferrules, the max. conductor cross section accommodated is one size smaller than max. rating of terminal block.

Jumpered

Supus modificărilor.

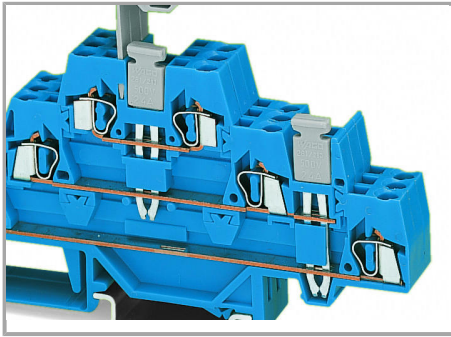

A vertical jumper allows commoning of the upper and lower levels, providing a 6-conductor feedthrough terminal block in one housing. Two adjacent triple-deck terminal blocks may be commoned together on the same level using a push-in adjacent jumper.

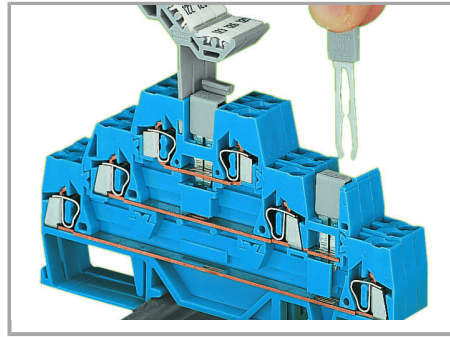

Combining vertical and adjacent jumpers.

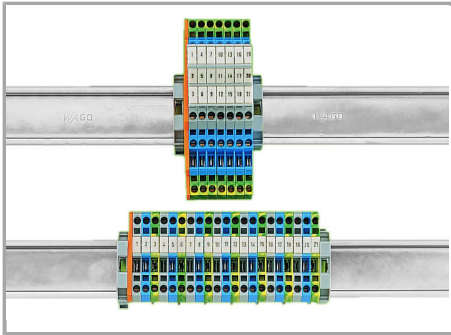

Save 67 % of rail space via triple-deck terminal blocks.

Marking

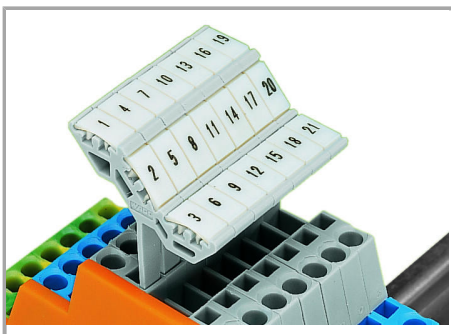

Labeling via WMB Multi Marking System.

Supus modificărilor.