

Fișă tehnică | Număr articol: 870-684

3-conductor through terminal block; 2.5 mm²; suitable for Ex i applications;
side and center marking; for DIN-rail 35 x 15 and 35 x 7.5; CAGE CLAMP®;
2,50 mm²; blue

www.wago.com/870-684

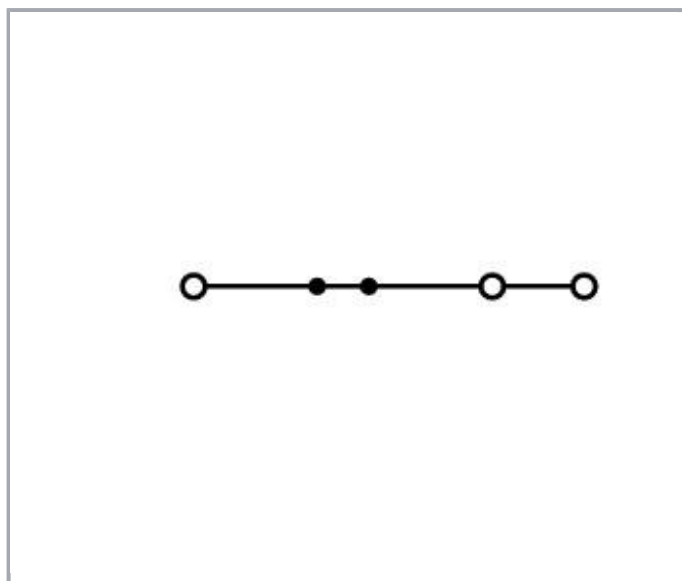
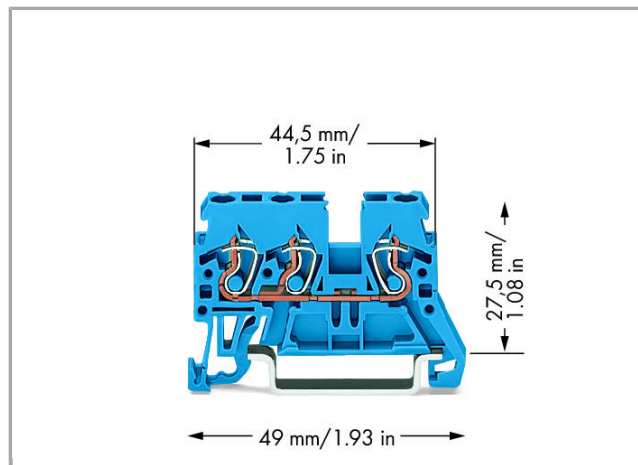
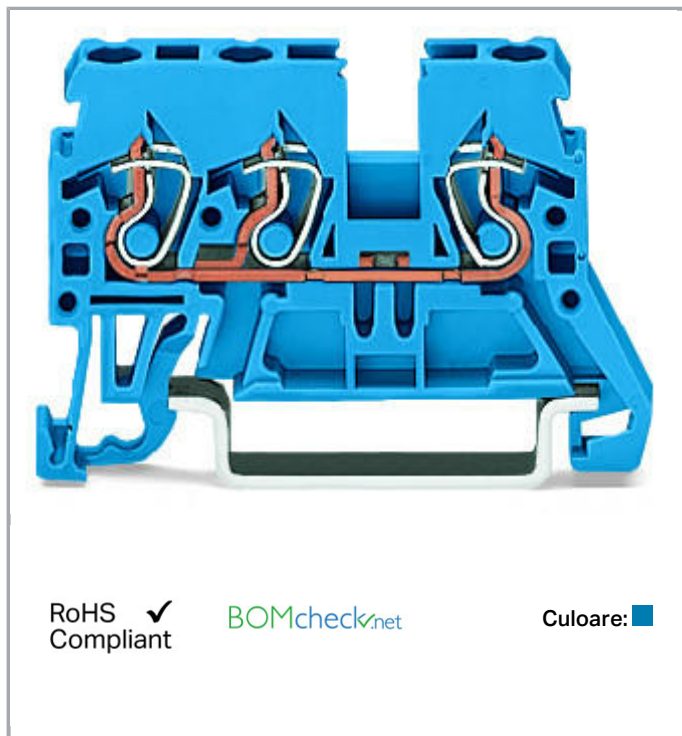

Supus modificărilor.

WAGO Kontakttechnik GmbH & Co. KG
/Representative Office Romania
Sos. Pipera-Tunari nr. 1/1
building 1, 2nd floor | 077190 Voluntari, Ilfov
Tel.: +40-(0)31 421 85 68 | Email: info-RO@wago.com

Aveți întrebări despre produsele noastre?
Vă stăm la dispoziție pentru preluarea apelului la +40 (0) 31 421 85 68.

Descriere articol

Safety information 1:

Max. insulation diameter: 4.4 mm

Date

Electrical data

Ratings per IEC/EN 60664-1

Ratings per	IEC/EN 60947-7-1
Nominal voltage (III/3)	500 V
Rated surge voltage (III/3)	6 kV
Rated current	24 A
Legend (ratings)	(III / 3) ≙ Overvoltage category III / Pollution degree 3

Connection data

Connection technology	CAGE CLAMP®
Actuation type	Operating tool
Connectable conductor materials	Copper
Solid conductor	0,08 ... 2,5 mm ² / 28 ... 12 AWG
Fine-stranded conductor	0,08 ... 4 mm ² / 28 ... 12 AWG
Strip length	6 ... 7 mm / 0.24 ... 0.28 inch
Total number of connection points	3
Total number of potentials	1
Number of levels	1
Wiring type	Front-entry wiring

Geometrical Data

Width	5 mm / 0.197 inch
Height from upper-edge of DIN-rail	27,5 mm / 1.083 inch
Depth	49 mm / 1.929 inch

Mechanical data

Design	horizontal type
Mounting type	DIN-35 rail
Marking level	Side marking

Supus modificărilor.

Material Data



Color	blue
Insulation material	Polyamide 66 (PA 66)
Fire load	0,101 MJ
Weight	6 g

Commercial data



Packaging type	BOX
Country of origin	DE
GTIN	4045454094584
Customs tariff number	85369010000

Aprobări / certificate

Country specific Approvals

Emblemă	Aprobare	Text de aprobare suplimentar	Nume certificat
	CCA DEKRA Certification B.V.	EN 60947	NTR NL 7468
	CCA DEKRA Certification B.V.	EN 60947	2189801.01

Ship Approvals





Emblemă	Aprobare	Text de aprobare suplimentar	Nume certificat
	ABS American Bureau of Shipping	-	20- HG1941090- PDA
	DNV GL Det Norske Veritas, Germanischer Lloyd	-	TAE00001V2
	LR Lloyds Register	EN 60947	91/20112 (E9)

Supus modificărilor.







Counterpart

Produse compatibile

End plate

	Nr. articol: 870-933 End and intermediate plate; 1 mm thick; gray	www.wago.com/870-933
	Nr. articol: 870-934 End and intermediate plate; 1 mm thick; orange	www.wago.com/870-934
	Nr. articol: 870-946 Separator plate; 1 mm thick; gray	www.wago.com/870-946
	Nr. articol: 870-947 Separator plate; 1 mm thick; orange	www.wago.com/870-947

















ferrule

	Nr. articol: 216-121 Ferrule; Sleeve for 0.5 mm ² / AWG 22; uninsulated; electro-tin plated	www.wago.com/216-121
	Nr. articol: 216-122 Ferrule; Sleeve for 0.75 mm ² / AWG 20; uninsulated; electro-tin plated	www.wago.com/216-122
	Nr. articol: 216-123 Ferrule; Sleeve for 1 mm ² / AWG 18; uninsulated; electro-tin plated	www.wago.com/216-123
	Nr. articol: 216-124 Ferrule; Sleeve for 1.5 mm ² / AWG 16; uninsulated; electro-tin plated	www.wago.com/216-124
	Nr. articol: 216-131 Ferrule; Sleeve for 0.25 mm ² / AWG 24; uninsulated; electro-tin plated	www.wago.com/216-131
	Nr. articol: 216-132 Ferrule; Sleeve for 0.34 mm ² / AWG 24; uninsulated; electro-tin plated	www.wago.com/216-132
	Nr. articol: 216-221 Ferrule; Sleeve for 0.5 mm ² / 20 AWG; insulated; electro-tin plated; white	www.wago.com/216-221

Supus modificărilor.

WAGO Kontakttechnik GmbH & Co. KG
/Representative Office Romania
Sos. Pipera-Tunari nr. 1/1
building 1, 2nd floor | 077190 Voluntari, Ilfov
Tel.: +40-(0)31 421 85 68 | Email: info-RO@wago.com

Aveți întrebări despre produsele noastre?
Vă stăm la dispoziție pentru preluarea apelului la +40 (0) 31 421 85 68.

	Nr. articol: 216-222 Ferrule; Sleeve for 0.75 mm ² / 18 AWG; insulated; electro-tin plated; gray	www.wago.com/216-222
	Nr. articol: 216-223 Ferrule; Sleeve for 1 mm ² / AWG 18; insulated; electro-tin plated; red	www.wago.com/216-223
	Nr. articol: 216-224 Ferrule; Sleeve for 1.5 mm ² / AWG 16; insulated; electro-tin plated; black	www.wago.com/216-224
	Nr. articol: 216-321 Ferrule; Sleeve for 0.25 mm ² / AWG 24; insulated; electro-tin plated; yellow	www.wago.com/216-321
	Nr. articol: 216-322 Ferrule; Sleeve for 0.34 mm ² / 22 AWG; insulated; electro-tin plated; green	www.wago.com/216-322
Jumper		
	Nr. articol: 709-110 Wire commoning chain; insulated; 4 connections; 3 x 110 mm; black	www.wago.com/709-110
	Nr. articol: 709-111 Wire commoning chain; insulated; 3 connections; 2 x 120 mm; black	www.wago.com/709-111
	Nr. articol: 709-112 Wire commoning chain; insulated; 3 connections; 2 x 170 mm; black	www.wago.com/709-112
	Nr. articol: 870-402 Push-in type jumper bar; insulated; 2-way; Nominal current 18 A; light gray	www.wago.com/870-402
	Nr. articol: 870-403 Push-in type jumper bar; insulated; 3-way; Nominal current 18 A; light gray	www.wago.com/870-403
	Nr. articol: 870-404 Push-in type jumper bar; insulated; 4-way; Nominal current 18 A; light gray	www.wago.com/870-404
	Nr. articol: 870-405 Push-in type jumper bar; insulated; 5-way; Nominal current 18 A; light gray	www.wago.com/870-405
	Nr. articol: 870-405/011-000 Ready-made push-in type jumper bar; insulated; 3-way (1-3-5); Nominal current 18 A; light gray	www.wago.com/870-405/011-000
	Nr. articol: 870-406 Push-in type jumper bar; insulated; 6-way; Nominal current 18 A; light gray	www.wago.com/870-406
	Nr. articol: 870-407 Push-in type jumper bar; insulated; 7-way; Nominal current 18 A; light gray	www.wago.com/870-407
	Nr. articol: 870-407/011-000 Ready-made push-in type jumper bar; insulated; 1-3-5-7; Nominal current 18 A; light gray	www.wago.com/870-407/011-000
	Nr. articol: 870-408 Push-in type jumper bar; insulated; 8-way; Nominal current 18 A; light gray	www.wago.com/870-408

Supus modificărilor.



Nr. articol: 870-409
Push-in type jumper bar; insulated; 9-way; Nominal current 18 A; light gray

www.wago.com/870-409



Nr. articol: 870-409/011-000
Ready-made push-in type jumper bar; insulated; 1-3-5-7-9; Nominal current 18 A; light gray

www.wago.com/870-409/011-000



Nr. articol: 870-410
Push-in type jumper bar; insulated; 10-way; Nominal current 18 A; light gray

www.wago.com/870-410



Nr. articol: 870-433
Push-in type jumper bar; insulated; from 1 to 3; Nominal current 18 A; light gray

www.wago.com/870-433



Nr. articol: 870-434
Push-in type jumper bar; insulated; from 1 to 4; Nominal current 18 A; light gray

www.wago.com/870-434

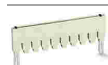

Nr. articol: 870-435
Push-in type jumper bar; insulated; from 1 to 5; Nominal current 18 A; light gray

www.wago.com/870-435

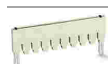

Nr. articol: 870-436
Push-in type jumper bar; insulated; from 1 to 6; Nominal current 18 A; light gray

www.wago.com/870-436



Nr. articol: 870-437
Push-in type jumper bar; insulated; from 1 to 7; Nominal current 18 A; light gray

www.wago.com/870-437



Nr. articol: 870-438
Push-in type jumper bar; insulated; from 1 to 8; Nominal current 18 A; light gray

www.wago.com/870-438



Nr. articol: 870-439
Push-in type jumper bar; insulated; from 1 to 9; Nominal current 18 A; light gray

www.wago.com/870-439

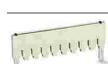

Nr. articol: 870-440
Push-in type jumper bar; insulated; from 1 to 10; Nominal current 18 A; light gray

www.wago.com/870-440

Marking accessories



Nr. articol: 2009-115
WMB-Inline; for Smart Printer; 1500 pieces on roll; stretchable 5 - 5.2 mm; plain; snap-on type; white

www.wago.com/2009-115



Nr. articol: 2009-115/000-002
WMB-Inline; for Smart Printer; 1500 pieces on roll; stretchable 5 - 5.2 mm; plain; snap-on type; yellow

www.wago.com/2009-115/000-002



Nr. articol: 2009-115/000-006
WMB-Inline; for Smart Printer; 1500 pieces on roll; stretchable 5 - 5.2 mm; plain; snap-on type; blue

www.wago.com/2009-115/000-006



Nr. articol: 2009-115/000-007
WMB-Inline; for Smart Printer; 1500 pieces on roll; stretchable 5 - 5.2 mm; plain; snap-on type; gray















www.wago.com/2009-115/000-007



Nr. articol: 2009-115/000-012
WMB-Inline; for Smart Printer; 1500 pieces on roll; stretchable 5 - 5.2 mm; plain; snap-on type; orange

www.wago.com/2009-115/000-012

Supus modificărilor.

	Nr. articol: 2009-115/000-017 WMB-Inline; for Smart Printer; 1500 pieces on roll; stretchable 5 - 5.2 mm; plain; snap-on type; light green	www.wago.com/2009-115/000-017
	Nr. articol: 2009-115/000-023 WMB-Inline; for Smart Printer; 1500 pieces on roll; stretchable 5 - 5.2 mm; plain; snap-on type; green	www.wago.com/2009-115/000-023
	Nr. articol: 2009-115/000-024 WMB-Inline; for Smart Printer; 1500 pieces on roll; stretchable 5 - 5.2 mm; plain; snap-on type; violet	www.wago.com/2009-115/000-024
	Nr. articol: 2009-145 Mini-WSB Inline; for Smart Printer; 1700 pieces on roll; stretchable 5 - 5.2 mm; plain; snap-on type; white	www.wago.com/2009-145
	Nr. articol: 2009-145/000-002 Mini-WSB Inline; for Smart Printer; 1700 pieces on roll; stretchable 5 - 5.2 mm; plain; snap-on type; yellow	www.wago.com/2009-145/000-002
	Nr. articol: 2009-145/000-005 Mini-WSB Inline; for Smart Printer; 1700 pieces on roll; stretchable 5 - 5.2 mm; plain; snap-on type; red	www.wago.com/2009-145/000-005
	Nr. articol: 2009-145/000-006 Mini-WSB Inline; for Smart Printer; 1700 pieces on roll; stretchable 5 - 5.2 mm; plain; snap-on type; blue	www.wago.com/2009-145/000-006
	Nr. articol: 2009-145/000-007 Mini-WSB Inline; for Smart Printer; 1700 pieces on roll; stretchable 5 - 5.2 mm; plain; snap-on type; gray	www.wago.com/2009-145/000-007
	Nr. articol: 2009-145/000-012 Mini-WSB Inline; for Smart Printer; 1700 pieces on roll; stretchable 5 - 5.2 mm; plain; snap-on type; orange	www.wago.com/2009-145/000-012
	Nr. articol: 2009-145/000-023 Mini-WSB Inline; for Smart Printer; 1700 pieces on roll; stretchable 5 - 5.2 mm; plain; snap-on type; green	www.wago.com/2009-145/000-023
	Nr. articol: 2009-145/000-024 Mini-WSB Inline; for Smart Printer; 1700 pieces on roll; stretchable 5 - 5.2 mm; plain; snap-on type; violet	www.wago.com/2009-145/000-024
	Nr. articol: 248-501 Miniature WSB Quick marking system; plain; Marker width 5 mm; 10 strips with 10 markers per card	www.wago.com/248-501
	Nr. articol: 248-501/000-002 Mini-WSB marking card; as card; not stretchable; plain; snap-on type; yellow	www.wago.com/248-501/000-002
	Nr. articol: 248-501/000-005 Mini-WSB marking card; as card; not stretchable; plain; snap-on type; red	www.wago.com/248-501/000-005

Supus modificărilor.

WAGO Kontakttechnik GmbH & Co. KG
/Representative Office Romania
Sos. Pipera-Tunari nr. 1/1
building 1, 2nd floor | 077190 Voluntari, Ilfov
Tel.: +40-(0)31 421 85 68 | Email: info-RO@wago.com

Aveți întrebări despre produsele noastre?
Vă stăm la dispoziție pentru preluarea apelului la +40 (0) 31 421 85 68.



Nr. articol: 248-501/000-006
Mini-WSB marking card; as card; not stretchable; plain; snap-on type; blue

www.wago.com/248-501/000-006



Nr. articol: 248-501/000-007
Mini-WSB marking card; as card; not stretchable; plain; snap-on type; gray

www.wago.com/248-501/000-007



Nr. articol: 248-501/000-012
Mini-WSB marking card; as card; not stretchable; plain; snap-on type; orange

www.wago.com/248-501/000-012



Nr. articol: 248-501/000-017
Mini-WSB marking card; as card; not stretchable; plain; snap-on type; light green

www.wago.com/248-501/000-017



Nr. articol: 248-501/000-023
Mini-WSB marking card; as card; not stretchable; plain; snap-on type; green

www.wago.com/248-501/000-023



Nr. articol: 248-501/000-024
Mini-WSB marking card; as card; not stretchable; plain; snap-on type; violet

www.wago.com/248-501/000-024



Nr. articol: 709-177
Marking strips; on reel; 7.5 mm wide; not stretchable; plain; snap-on type; translucent

www.wago.com/709-177



Nr. articol: 709-178
Marking strips; on reel; 7.5 mm wide; not stretchable; plain; snap-on type; white

www.wago.com/709-178



Nr. articol: 709-196
Marking strips; for laser printer; translucent

www.wago.com/709-196



Nr. articol: 709-198
Marking strips; white

www.wago.com/709-198



Nr. articol: 793-501
WMB marking card; as card; not stretchable; plain; snap-on type; white

www.wago.com/793-501



Nr. articol: 793-501/000-002
WMB marking card; as card; not stretchable; plain; snap-on type; yellow

www.wago.com/793-501/000-002



Nr. articol: 793-501/000-005
WMB marking card; as card; not stretchable; plain; snap-on type; red

www.wago.com/793-501/000-005



Nr. articol: 793-501/000-006
WMB marking card; as card; not stretchable; plain; snap-on type; blue













www.wago.com/793-501/000-006



Nr. articol: 793-501/000-007
WMB marking card; as card; not stretchable; plain; snap-on type; gray

www.wago.com/793-501/000-007

Supus modificărilor.

















	Nr. articol: 793-501/000-012 WMB marking card; as card; not stretchable; plain; snap-on type; orange	www.wago.com/793-501/000-012
	Nr. articol: 793-501/000-017 WMB marking card; as card; not stretchable; plain; snap-on type; light green	www.wago.com/793-501/000-017
	Nr. articol: 793-501/000-023 WMB marking card; as card; not stretchable; plain; snap-on type; green	www.wago.com/793-501/000-023
	Nr. articol: 793-501/000-024 WMB marking card; as card; not stretchable; plain; snap-on type; violet	www.wago.com/793-501/000-024
	Nr. articol: 793-5501 WMB marking card; as card; for terminal block width 5 - 17.5 mm; stretchable 5 - 5.2 mm; plain; snap-on type; white	www.wago.com/793-5501
	Nr. articol: 793-5501/000-002 WMB marking card; as card; for terminal block width 5 - 17.5 mm; stretchable 5 - 5.2 mm; plain; snap-on type; yellow	www.wago.com/793-5501/000-002
	Nr. articol: 793-5501/000-005 WMB marking card; as card; for terminal block width 5 - 17.5 mm; stretchable 5 - 5.2 mm; plain; snap-on type; red	www.wago.com/793-5501/000-005
	Nr. articol: 793-5501/000-006 WMB marking card; as card; for terminal block width 5 - 17.5 mm; stretchable 5 - 5.2 mm; plain; snap-on type; blue	www.wago.com/793-5501/000-006
	Nr. articol: 793-5501/000-007 WMB marking card; as card; for terminal block width 5 - 17.5 mm; stretchable 5 - 5.2 mm; plain; snap-on type; gray	www.wago.com/793-5501/000-007
	Nr. articol: 793-5501/000-012 WMB marking card; as card; for terminal block width 5 - 17.5 mm; stretchable 5 - 5.2 mm; plain; snap-on type; orange	www.wago.com/793-5501/000-012
	Nr. articol: 793-5501/000-017 WMB marking card; as card; for terminal block width 5 - 17.5 mm; stretchable 5 - 5.2 mm; plain; snap-on type; green	www.wago.com/793-5501/000-017
	Nr. articol: 793-5501/000-023 WMB marking card; as card; for terminal block width 5 - 17.5 mm; stretchable 5 - 5.2 mm; plain; snap-on type; light green	www.wago.com/793-5501/000-023
	Nr. articol: 793-5501/000-024 WMB marking card; as card; for terminal block width 5 - 17.5 mm; stretchable 5 - 5.2 mm; plain; snap-on type; violet	www.wago.com/793-5501/000-024

Insulation stop













Supus modificărilor.

WAGO Kontakttechnik GmbH & Co. KG
/Representative Office Romania
Sos. Pipera-Tunari nr. 1/1
building 1, 2nd floor | 077190 Voluntari, Ilfov
Tel.: +40-(0)31 421 85 68 | Email: info-RO@wago.com

Aveți întrebări despre produsele noastre?
Vă stăm la dispoziție pentru preluarea apelului la +40 (0) 31 421 85 68.

	Nr. articol: 280-470 Insulation stop; 0.08 - 0.2 mm ² "s" (0.14 mm ² "f-st"); 5 pieces/strip; white	www.wago.com/280-470
	Nr. articol: 280-471 Insulation stop; 0.25 - 0.5 mm ² ; 5 pieces/strip; light gray	www.wago.com/280-471
	Nr. articol: 280-472 Insulation stop; 0.75 - 1 mm ² ; 5 pieces/strip	www.wago.com/280-472
assembling		
	Nr. articol: 209-106 Mounting carrier; for isolated mounting on DIN 35 rails; gray	www.wago.com/209-106
	Nr. articol: 249-116 Screwless end stop; 6 mm wide; for DIN-rail 35 x 15 and 35 x 7.5; gray	www.wago.com/249-116
	Nr. articol: 249-117 Screwless end stop; 10 mm wide; for DIN-rail 35 x 15 and 35 x 7.5; gray	www.wago.com/249-117
Protective Warning Marker		
	Nr. articol: 280-405 Protective warning marker; with high-voltage symbol, black; for 5 terminal blocks; yellow	www.wago.com/280-405
General accessories		
	Nr. articol: 870-182 Adaptor; gray	www.wago.com/870-182
	Nr. articol: 870-183 Adaptor; gray	www.wago.com/870-183
	Nr. articol: 870-184 Adaptor; gray	www.wago.com/870-184
	Nr. articol: 870-425 Tap-off module; with anti-rotation protection; modular; suitable for 870 Series terminal blocks with jumper slots in the current bar; gray	www.wago.com/870-425
	Nr. articol: 870-426 Tap-off module; modular; suitable for 870 Series terminal blocks with jumper slots in the current bar; gray	www.wago.com/870-426
	Nr. articol: 870-427 Spacer module; modular; bridging commoned terminal blocks; gray	www.wago.com/870-427
Carrier rail		
	Nr. articol: 210-112 Steel carrier rail; 35 x 7.5 mm; 1 mm thick; 2 m long; slotted; according to EN 60715; "Hole width 25 mm	www.wago.com/210-112
	Nr. articol: 210-113 Steel carrier rail; 35 x 7.5 mm; 1 mm thick; 2 m long; unslotted; according to EN 60715	www.wago.com/210-113
	Nr. articol: 210-114 Steel carrier rail; 35 x 15 mm; 1.5 mm thick; 2 m long; unslotted; similar to EN 60715	www.wago.com/210-114

Supus modificărilor.

	Nr. articol: 210-115 Steel carrier rail; 35 x 7.5 mm; 1 mm thick; 2 m long; slotted; according to EN 60715; "Hole width 18 mm	www.wago.com/210-115
	Nr. articol: 210-118 Steel carrier rail; 35 x 15 mm; 2.3 mm thick; 2 m long; unslotted; according to EN 60715	www.wago.com/210-118
	Nr. articol: 210-196 Aluminum carrier rail; 35 x 8.2 mm; 1.6 mm thick; 2 m long; unslotted; similar to EN 60715; silver-colored	www.wago.com/210-196
	Nr. articol: 210-197 Steel carrier rail; 35 x 15 mm; 1.5 mm thick; 2 m long; slotted; similar to EN 60715	www.wago.com/210-197
	Nr. articol: 210-198 Copper carrier rail; 35 x 15 mm; 2.3 mm thick; 2 m long; unslotted; according to EN 60715; copper-colored	www.wago.com/210-198
	Nr. articol: 210-504 Steel carrier rail; 35 x 7.5 mm; 1 mm thick; 2 m long; slotted; galvanized; according to EN 60715	www.wago.com/210-504
	Nr. articol: 210-505 Steel carrier rail; 35 x 7.5 mm; 1 mm thick; 2 m long; unslotted; galvanized; according to EN 60715	www.wago.com/210-505
	Nr. articol: 210-506 Steel carrier rail; 35 x 15 mm; 1.5 mm thick; 2 m long; unslotted; galvanized; similar to EN 60715	www.wago.com/210-506
	Nr. articol: 210-508 Steel carrier rail; 35 x 15 mm; 1.5 mm thick; 2 m long; slotted; galvanized; similar to EN 60715	www.wago.com/210-508
tools		
	Nr. articol: 210-657 Operating tool; Blade: 3.5 x 0.5 mm; with a partially insulated shaft; short	www.wago.com/210-657
	Nr. articol: 210-658 Operating tool; Blade: 3.5 x 0.5 mm; with a partially insulated shaft; angled; short	www.wago.com/210-658
	Nr. articol: 210-720 Operating tool; Blade: 3.5 x 0.5 mm; with a partially insulated shaft	www.wago.com/210-720

Descărcări

Documentation

Additional Information

Technical explanations	Apr 3, 2019	pdf 2,1 MB	Descărcare
------------------------	-------------	---------------	------------

CAD/CAE-Data

CAD data

2D/3D Models 870-684	URL	Descărcare
----------------------	-----	------------

Supus modificărilor.

WAGO Kontakttechnik GmbH & Co. KG
/Representative Office Romania
Sos. Pipera-Tunari nr. 1/1
building 1, 2nd floor | 077190 Voluntari, Ilfov
Tel.: +40-(0)31 421 85 68 | Email: info-RO@wago.com

Aveți întrebări despre produsele noastre?
Vă stăm la dispoziție pentru preluarea apelului la +40 (0) 31 421 85 68.

CAE data

EPLAN Data Portal 870-684

URL

Descărcare

WSCAD Universe 870-684

URL

Descărcare

Installation Notes

Assembly

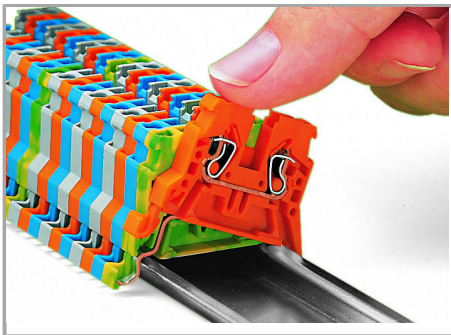

Snapping a rail-mount terminal block onto DIN-35 rail.

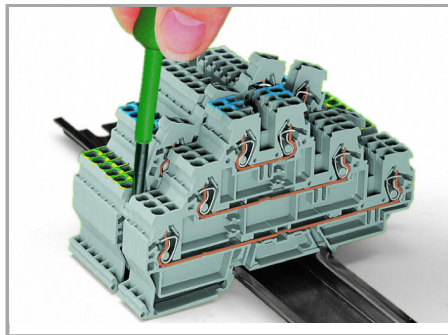

Removing a terminal block from the assembly.

Inserting a conductor

Supus modificărilor.

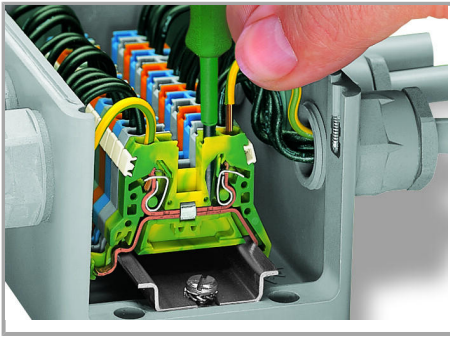

CAGE CLAMP® connection

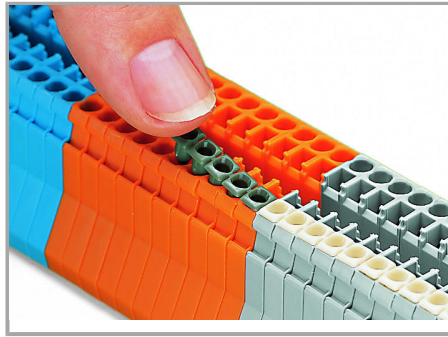

Inserting an insulation stop into conductor entry holes of terminal strip.

Inserting a conductor (0.08 ... 4 mm² "f-st").

With ferruled conductors, it is necessary to use a terminal block one size smaller than the conductor's nominal cross section.

Jumpered

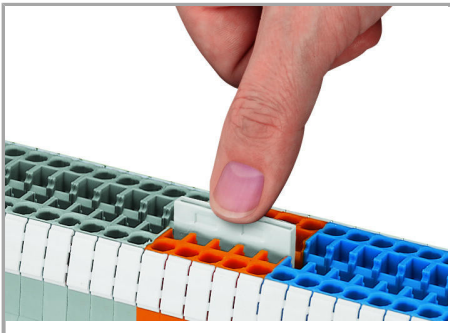

Push jumper bars down firmly until fully inserted. When using multipole bars, push alternately on the right and then left side, until installed.



Commoning with push-in type jumper bars:

Two parallel jumper slots are accommodated in one terminal block.

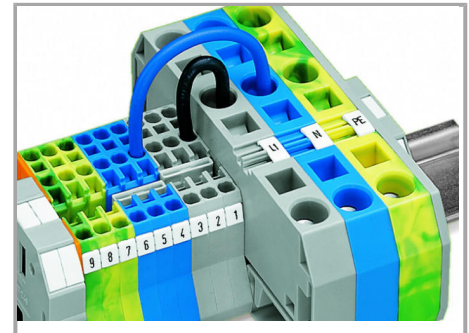

Commoning terminal blocks of different sizes via step-down jumpers.

Push-in type jumper bars 1 – 3 – 5 – 7 or 1 – – 4 – – 7

upon request

Supus modificărilor.

Testing

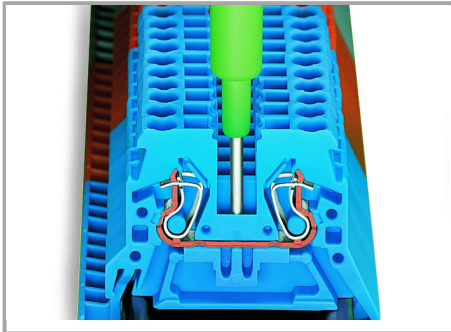

Testing with phase testing device, also possible with single-pole voltage tester.

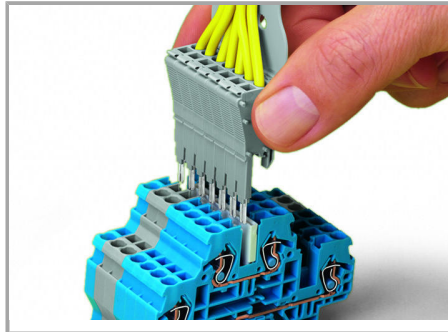

Testing is also possible using a pre-wired tap-off module assembly in the very same way as test plugs.

Cover

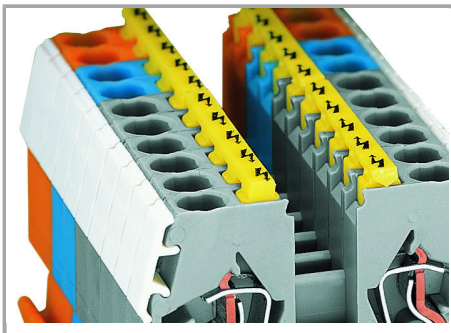

Protective warning markers (280-405), with a black high-voltage symbol

Marking

Supus modificărilor.

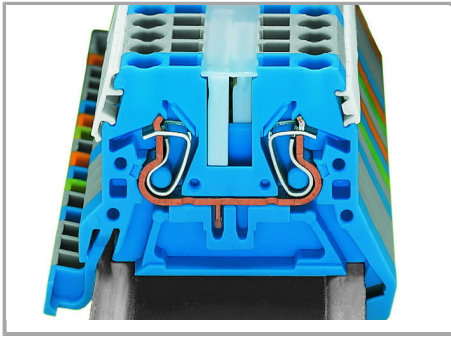

WMB markers in Mini-WSB marker slots

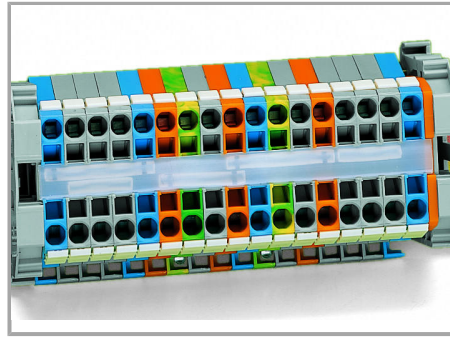

Translucent marking strip (709-196) – jumper bars below may be visible.

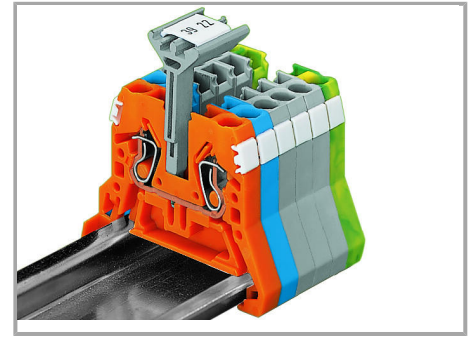

In addition to the plastic marker strips, group marker carriers are now available for the WMB and WSB marking systems. They can be mounted parallel to a push-in type jumper bar via open jumper contact slot. It assists with viewing marker slots on the side of the terminal block. Group marker carriers are available in 5 mm/0.197 inch, 10 mm/0.394 inch and 15 mm/0.591 inch widths.

Marking strip, translucent

Mini-WSB markers

Notice:

Marker carriers are not suitable for ground conductor terminal blocks and double-potential terminal blocks as they have no jumper contact slots.

Supus modificărilor.