

Fișă tehnică | Număr articol: 870-904

2-conductor through terminal block; 2.5 mm²; suitable for Ex i applications;
side and center marking; for DIN-rail 35 x 15 and 35 x 7.5; CAGE CLAMP®;
2,50 mm²; blue

www.wago.com/870-904

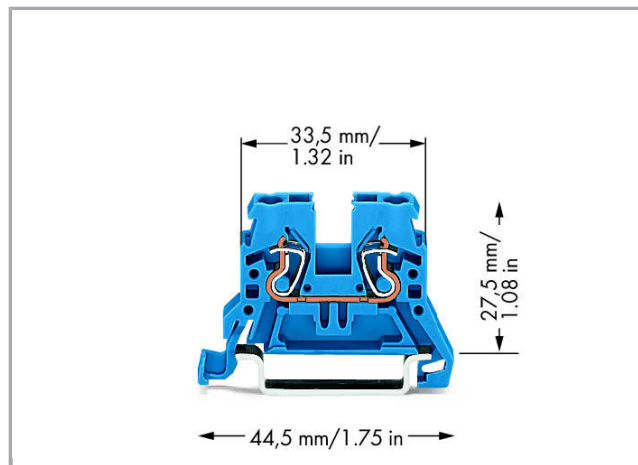

Supus modificărilor.

WAGO Kontakttechnik GmbH & Co. KG
/Representative Office Romania
Sos. Pipera-Tunari nr. 1/1
building 1, 2nd floor | 077190 Voluntari, Ilfov
Tel.: +40-(0)31 421 85 68 | Email: info-RO@wago.com

Aveți întrebări despre produsele noastre?
Vă stăm la dispoziție pentru preluarea apelului la +40 (0) 31 421 85 68.

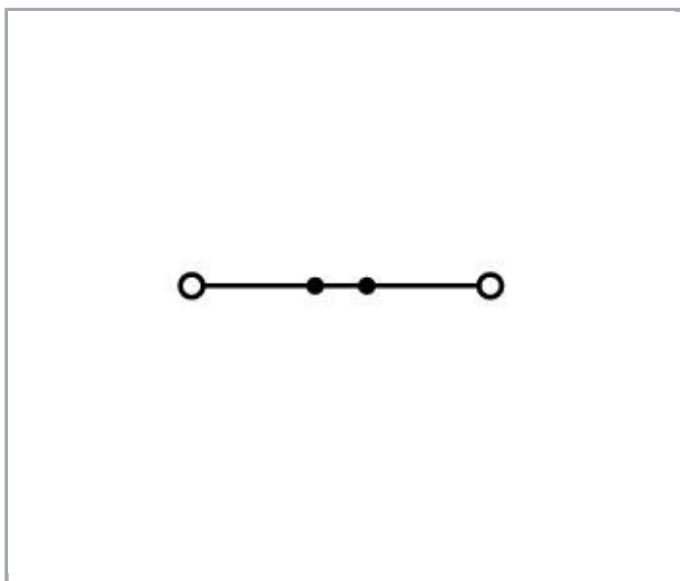

Descriere articol

Safety information 1:

Max. insulation diameter: 4.4 mm

Date

Electrical data

Ratings per IEC/EN 60664-1

Ratings per	IEC/EN 60947-7-1
Nominal voltage (III/3)	500 V
Rated surge voltage (III/3)	6 kV
Rated current	24 A
Legend (ratings)	(III / 3) ≙ Overvoltage category III / Pollution degree 3

Connection data

Connection technology	CAGE CLAMP®
Actuation type	Operating tool
Connectable conductor materials	Copper
Solid conductor	0,08 ... 2,5 mm ² / 28 ... 12 AWG
Fine-stranded conductor	0,08 ... 4 mm ² / 28 ... 12 AWG
Strip length	6 ... 7 mm / 0.24 ... 0.28 inch
Total number of connection points	2

Supus modificărilor.

WAGO Kontakttechnik GmbH & Co. KG
 /Representative Office Romania
 Sos. Pipera-Tunari nr. 1/1
 building 1, 2nd floor | 077190 Voluntari, Ilfov
 Tel.: +40-(0)31 421 85 68 | Email: info-RO@wago.com

Aveți întrebări despre produsele noastre?
 Vă stăm la dispoziție pentru preluarea apelului la +40 (0) 31 421 85 68.



Total number of potentials	1
Number of levels	1
Wiring type	Front-entry wiring

Geometrical Data

Width	5 mm / 0.197 inch
Height from upper-edge of DIN-rail	27,5 mm / 1.083 inch
Depth	44,5 mm / 1.752 inch

Mechanical data

Design	horizontal type
Mounting type	DIN-35 rail
Marking level	Side marking

Material Data

Color	blue
Insulation material	Polyamide 66 (PA 66)
Fire load	0,08 MJ
Weight	4,3 g

Commercial data

Product Group	16 (Rail Mounted Terminal Block with CCC)
Packaging type	BOX
Country of origin	DE
GTIN	4044918478380
Customs tariff number	85369010000

Aprobări / certificate





Country specific Approvals

Emblemă	Aprobare	Text de aprobare suplimentar	Nume certificat
	CCA DEKRA Certification B.V.	EN 60947	NTR NL 7468
	CCA DEKRA Certification B.V.	EN 60947	2189801.01

Supus modificărilor.



Ship Approvals

Emblemă	Aprobare	Text de aprobare suplimentar	Nume certificat
	ABS American Bureau of Shipping	-	20- HG1941090- PDA
	BV Bureau Veritas S.A.	EN 60947	07436/E0 BV
	DNV GL Det Norske Veritas, Germanischer Lloyd	-	TAE00001V2
	LR Lloyds Register	EN 60947	91/20112 (E9)

UL-Approvals

Emblemă	Aprobare	Text de aprobare suplimentar	Nume certificat
	cURus UL International Germany GmbH	UL 1059	20160928- E45172

Counterpart



Produse compatibile

Supus modificărilor.











WAGO Kontakttechnik GmbH & Co. KG
/Representative Office Romania
Sos. Pipera-Tunari nr. 1/1
building 1, 2nd floor | 077190 Voluntari, Ilfov
Tel.: +40-(0)31 421 85 68 | Email: info-RO@wago.com

Aveți întrebări despre produsele noastre?
Vă stăm la dispoziție pentru preluarea apelului la +40 (0) 31 421 85 68.

tools

	Nr. articol: 210-657 Operating tool; Blade: 3.5 x 0.5 mm; with a partially insulated shaft; short	www.wago.com/210-657
	Nr. articol: 210-658 Operating tool; Blade: 3.5 x 0.5 mm; with a partially insulated shaft; angled; short	www.wago.com/210-658
	Nr. articol: 210-720 Operating tool; Blade: 3.5 x 0.5 mm; with a partially insulated shaft	www.wago.com/210-720

ferrule













	Nr. articol: 216-121 Ferrule; Sleeve for 0.5 mm ² / AWG 22; uninsulated; electro-tin plated	www.wago.com/216-121
	Nr. articol: 216-122 Ferrule; Sleeve for 0.75 mm ² / AWG 20; uninsulated; electro-tin plated	www.wago.com/216-122
	Nr. articol: 216-123 Ferrule; Sleeve for 1 mm ² / AWG 18; uninsulated; electro-tin plated	www.wago.com/216-123
	Nr. articol: 216-124 Ferrule; Sleeve for 1.5 mm ² / AWG 16; uninsulated; electro-tin plated	www.wago.com/216-124
	Nr. articol: 216-131 Ferrule; Sleeve for 0.25 mm ² / AWG 24; uninsulated; electro-tin plated	www.wago.com/216-131
	Nr. articol: 216-132 Ferrule; Sleeve for 0.34 mm ² / AWG 24; uninsulated; electro-tin plated	www.wago.com/216-132
	Nr. articol: 216-221 Ferrule; Sleeve for 0.5 mm ² / 20 AWG; insulated; electro-tin plated; white	www.wago.com/216-221
	Nr. articol: 216-222 Ferrule; Sleeve for 0.75 mm ² / 18 AWG; insulated; electro-tin plated; gray	www.wago.com/216-222
	Nr. articol: 216-223 Ferrule; Sleeve for 1 mm ² / AWG 18; insulated; electro-tin plated; red	www.wago.com/216-223
	Nr. articol: 216-224 Ferrule; Sleeve for 1.5 mm ² / AWG 16; insulated; electro-tin plated; black	www.wago.com/216-224
	Nr. articol: 216-321 Ferrule; Sleeve for 0.25 mm ² / AWG 24; insulated; electro-tin plated; yellow	www.wago.com/216-321
	Nr. articol: 216-322 Ferrule; Sleeve for 0.34 mm ² / 22 AWG; insulated; electro-tin plated; green	www.wago.com/216-322

Protective Warning Marker

	Nr. articol: 280-405 Protective warning marker; with high-voltage symbol, black; for 5 terminal blocks; yellow	www.wago.com/280-405
--	--	--

Supus modificărilor.















Marking accessories

	Nr. articol: 2009-115 WMB-Inline; for Smart Printer; 1500 pieces on roll; stretchable 5 - 5.2 mm; plain; snap-on type; white	www.wago.com/2009-115
	Nr. articol: 2009-115/000-002 WMB-Inline; for Smart Printer; 1500 pieces on roll; stretchable 5 - 5.2 mm; plain; snap-on type; yellow	www.wago.com/2009-115/000-002
	Nr. articol: 2009-115/000-006 WMB-Inline; for Smart Printer; 1500 pieces on roll; stretchable 5 - 5.2 mm; plain; snap-on type; blue	www.wago.com/2009-115/000-006
	Nr. articol: 2009-115/000-007 WMB-Inline; for Smart Printer; 1500 pieces on roll; stretchable 5 - 5.2 mm; plain; snap-on type; gray	www.wago.com/2009-115/000-007
	Nr. articol: 2009-115/000-012 WMB-Inline; for Smart Printer; 1500 pieces on roll; stretchable 5 - 5.2 mm; plain; snap-on type; orange	www.wago.com/2009-115/000-012
	Nr. articol: 2009-115/000-017 WMB-Inline; for Smart Printer; 1500 pieces on roll; stretchable 5 - 5.2 mm; plain; snap-on type; light green	www.wago.com/2009-115/000-017
	Nr. articol: 2009-115/000-023 WMB-Inline; for Smart Printer; 1500 pieces on roll; stretchable 5 - 5.2 mm; plain; snap-on type; green	www.wago.com/2009-115/000-023
	Nr. articol: 2009-115/000-024 WMB-Inline; for Smart Printer; 1500 pieces on roll; stretchable 5 - 5.2 mm; plain; snap-on type; violet	www.wago.com/2009-115/000-024
	Nr. articol: 2009-145 Mini-WSB Inline; for Smart Printer; 1700 pieces on roll; stretchable 5 - 5.2 mm; plain; snap-on type; white	www.wago.com/2009-145
	Nr. articol: 2009-145/000-002 Mini-WSB Inline; for Smart Printer; 1700 pieces on roll; stretchable 5 - 5.2 mm; plain; snap-on type; yellow	www.wago.com/2009-145/000-002
	Nr. articol: 2009-145/000-005 Mini-WSB Inline; for Smart Printer; 1700 pieces on roll; stretchable 5 - 5.2 mm; plain; snap-on type; red	www.wago.com/2009-145/000-005
	Nr. articol: 2009-145/000-006 Mini-WSB Inline; for Smart Printer; 1700 pieces on roll; stretchable 5 - 5.2 mm; plain; snap-on type; blue	www.wago.com/2009-145/000-006
	Nr. articol: 2009-145/000-007 Mini-WSB Inline; for Smart Printer; 1700 pieces on roll; stretchable 5 - 5.2 mm; plain; snap-on type; gray	www.wago.com/2009-145/000-007
	Nr. articol: 2009-145/000-012	















Supus modificărilor.

WAGO Kontakttechnik GmbH & Co. KG
/Representative Office Romania
Sos. Pipera-Tunari nr. 1/1
building 1, 2nd floor | 077190 Voluntari, Ilfov
Tel.: +40-(0)31 421 85 68 | Email: info-RO@wago.com

Aveți întrebări despre produsele noastre?
Vă stăm la dispoziție pentru preluarea apelului la +40 (0) 31 421 85 68.

	Mini-WSB Inline; for Smart Printer; 1700 pieces on roll; stretchable 5 - 5.2 mm; plain; snap-on type; orange	www.wago.com/2009-145/000-012
	Nr. articol: 2009-145/000-023 Mini-WSB Inline; for Smart Printer; 1700 pieces on roll; stretchable 5 - 5.2 mm; plain; snap-on type; green	www.wago.com/2009-145/000-023
	Nr. articol: 2009-145/000-024 Mini-WSB Inline; for Smart Printer; 1700 pieces on roll; stretchable 5 - 5.2 mm; plain; snap-on type; violet	www.wago.com/2009-145/000-024
	Nr. articol: 248-501 Miniature WSB Quick marking system; plain; Marker width 5 mm; 10 strips with 10 markers per card	www.wago.com/248-501
	Nr. articol: 248-501/000-002 Mini-WSB marking card; as card; not stretchable; plain; snap-on type; yellow	www.wago.com/248-501/000-002
	Nr. articol: 248-501/000-005 Mini-WSB marking card; as card; not stretchable; plain; snap-on type; red	www.wago.com/248-501/000-005
	Nr. articol: 248-501/000-006 Mini-WSB marking card; as card; not stretchable; plain; snap-on type; blue	www.wago.com/248-501/000-006
	Nr. articol: 248-501/000-007 Mini-WSB marking card; as card; not stretchable; plain; snap-on type; gray	www.wago.com/248-501/000-007
	Nr. articol: 248-501/000-012 Mini-WSB marking card; as card; not stretchable; plain; snap-on type; orange	www.wago.com/248-501/000-012
	Nr. articol: 248-501/000-017 Mini-WSB marking card; as card; not stretchable; plain; snap-on type; light green	www.wago.com/248-501/000-017
	Nr. articol: 248-501/000-023 Mini-WSB marking card; as card; not stretchable; plain; snap-on type; green	www.wago.com/248-501/000-023
	Nr. articol: 248-501/000-024 Mini-WSB marking card; as card; not stretchable; plain; snap-on type; violet	www.wago.com/248-501/000-024
	Nr. articol: 709-177 Marking strips; on reel; 7.5 mm wide; not stretchable; plain; snap-on type; translucent	www.wago.com/709-177
	Nr. articol: 709-178 Marking strips; on reel; 7.5 mm wide; not stretchable; plain; snap-on type; white	www.wago.com/709-178

Supus modificărilor.

	Nr. articol: 709-196 Marking strips; for laser printer; translucent	www.wago.com/709-196
	Nr. articol: 709-198 Marking strips; white	www.wago.com/709-198
	Nr. articol: 793-501 WMB marking card; as card; not stretchable; plain; snap-on type; white	www.wago.com/793-501
	Nr. articol: 793-501/000-002 WMB marking card; as card; not stretchable; plain; snap-on type; yellow	www.wago.com/793-501/000-002
	Nr. articol: 793-501/000-005 WMB marking card; as card; not stretchable; plain; snap-on type; red	www.wago.com/793-501/000-005
	Nr. articol: 793-501/000-006 WMB marking card; as card; not stretchable; plain; snap-on type; blue	www.wago.com/793-501/000-006
	Nr. articol: 793-501/000-007 WMB marking card; as card; not stretchable; plain; snap-on type; gray	www.wago.com/793-501/000-007
	Nr. articol: 793-501/000-012 WMB marking card; as card; not stretchable; plain; snap-on type; orange	www.wago.com/793-501/000-012
	Nr. articol: 793-501/000-017 WMB marking card; as card; not stretchable; plain; snap-on type; light green	www.wago.com/793-501/000-017
	Nr. articol: 793-501/000-023 WMB marking card; as card; not stretchable; plain; snap-on type; green	www.wago.com/793-501/000-023
	Nr. articol: 793-501/000-024 WMB marking card; as card; not stretchable; plain; snap-on type; violet	www.wago.com/793-501/000-024
	Nr. articol: 793-5501 WMB marking card; as card; for terminal block width 5 - 17.5 mm; stretchable 5 - 5.2 mm; plain; snap-on type; white	www.wago.com/793-5501
	Nr. articol: 793-5501/000-002 WMB marking card; as card; for terminal block width 5 - 17.5 mm; stretchable 5 - 5.2 mm; plain; snap-on type; yellow	www.wago.com/793-5501/000-002
	Nr. articol: 793-5501/000-005 WMB marking card; as card; for terminal block width 5 - 17.5 mm; stretchable 5 - 5.2 mm; plain; snap-on type; red	www.wago.com/793-5501/000-005
	Nr. articol: 793-5501/000-006	

Supus modificărilor.



WMB marking card; as card; for terminal block width 5 - 17.5 mm; stretchable 5 - 5.2 mm; plain; snap-on type; blue

www.wago.com/793-5501/000-006



Nr. articol: 793-5501/000-007

WMB marking card; as card; for terminal block width 5 - 17.5 mm; stretchable 5 - 5.2 mm; plain; snap-on type; gray

www.wago.com/793-5501/000-007



Nr. articol: 793-5501/000-012

WMB marking card; as card; for terminal block width 5 - 17.5 mm; stretchable 5 - 5.2 mm; plain; snap-on type; orange

www.wago.com/793-5501/000-012



Nr. articol: 793-5501/000-017

WMB marking card; as card; for terminal block width 5 - 17.5 mm; stretchable 5 - 5.2 mm; plain; snap-on type; green

www.wago.com/793-5501/000-017



Nr. articol: 793-5501/000-023

WMB marking card; as card; for terminal block width 5 - 17.5 mm; stretchable 5 - 5.2 mm; plain; snap-on type; light green

www.wago.com/793-5501/000-023



Nr. articol: 793-5501/000-024

WMB marking card; as card; for terminal block width 5 - 17.5 mm; stretchable 5 - 5.2 mm; plain; snap-on type; violet

www.wago.com/793-5501/000-024

Jumper



Nr. articol: 709-110

Wire commoning chain; insulated; 4 connections; 3 x 110 mm; black

www.wago.com/709-110



Nr. articol: 709-111

Wire commoning chain; insulated; 3 connections; 2 x 120 mm; black

www.wago.com/709-111



Nr. articol: 709-112

Wire commoning chain; insulated; 3 connections; 2 x 170 mm; black

www.wago.com/709-112



Nr. articol: 870-402

Push-in type jumper bar; insulated; 2-way; Nominal current 18 A; light gray

www.wago.com/870-402



Nr. articol: 870-403

Push-in type jumper bar; insulated; 3-way; Nominal current 18 A; light gray

www.wago.com/870-403



Nr. articol: 870-404

Push-in type jumper bar; insulated; 4-way; Nominal current 18 A; light gray

www.wago.com/870-404



Nr. articol: 870-405

Push-in type jumper bar; insulated; 5-way; Nominal current 18 A; light gray

www.wago.com/870-405



Nr. articol: 870-405/011-000

Ready-made push-in type jumper bar; insulated; 3-way (1-3-5); Nominal current 18 A; light gray

www.wago.com/870-405/011-000



















Nr. articol: 870-406

Push-in type jumper bar; insulated; 6-way; Nominal current 18 A; light gray





www.wago.com/870-406

Supus modificărilor.



	Nr. articol: 870-407 Push-in type jumper bar; insulated; 7-way; Nominal current 18 A; light gray	www.wago.com/870-407
	Nr. articol: 870-407/011-000 Ready-made push-in type jumper bar; insulated; 1-3-5-7; Nominal current 18 A; light gray	www.wago.com/870-407/011-000
	Nr. articol: 870-408 Push-in type jumper bar; insulated; 8-way; Nominal current 18 A; light gray	www.wago.com/870-408
	Nr. articol: 870-409 Push-in type jumper bar; insulated; 9-way; Nominal current 18 A; light gray	www.wago.com/870-409
	Nr. articol: 870-409/011-000 Ready-made push-in type jumper bar; insulated; 1-3-5-7-9; Nominal current 18 A; light gray	www.wago.com/870-409/011-000
	Nr. articol: 870-410 Push-in type jumper bar; insulated; 10-way; Nominal current 18 A; light gray	www.wago.com/870-410
	Nr. articol: 870-433 Push-in type jumper bar; insulated; from 1 to 3; Nominal current 18 A; light gray	www.wago.com/870-433
	Nr. articol: 870-434 Push-in type jumper bar; insulated; from 1 to 4; Nominal current 18 A; light gray	www.wago.com/870-434
	Nr. articol: 870-435 Push-in type jumper bar; insulated; from 1 to 5; Nominal current 18 A; light gray	www.wago.com/870-435
	Nr. articol: 870-436 Push-in type jumper bar; insulated; from 1 to 6; Nominal current 18 A; light gray	www.wago.com/870-436
	Nr. articol: 870-437 Push-in type jumper bar; insulated; from 1 to 7; Nominal current 18 A; light gray	www.wago.com/870-437
	Nr. articol: 870-438 Push-in type jumper bar; insulated; from 1 to 8; Nominal current 18 A; light gray	www.wago.com/870-438
	Nr. articol: 870-439 Push-in type jumper bar; insulated; from 1 to 9; Nominal current 18 A; light gray	www.wago.com/870-439
	Nr. articol: 870-440 Push-in type jumper bar; insulated; from 1 to 10; Nominal current 18 A; light gray	www.wago.com/870-440
assembling		
	Nr. articol: 209-106 Mounting carrier; for isolated mounting on DIN 35 rails; gray	www.wago.com/209-106
	Nr. articol: 249-116 Screwless end stop; 6 mm wide; for DIN-rail 35 x 15 and 35 x 7.5; gray	www.wago.com/249-116
	Nr. articol: 249-117 Screwless end stop; 10 mm wide; for DIN-rail 35 x 15 and 35 x 7.5; gray	www.wago.com/249-117

Supus modificărilor.











End plate

	Nr. articol: 870-923 End and intermediate plate; 2 mm thick; gray	www.wago.com/870-923
	Nr. articol: 870-924 End and intermediate plate; 2 mm thick; orange	www.wago.com/870-924
	Nr. articol: 870-928 Separator plate; 2 mm thick; oversized; gray	www.wago.com/870-928
	Nr. articol: 870-929 Separator plate; 2 mm thick; oversized; orange	www.wago.com/870-929

Insulation stop

	Nr. articol: 280-470 Insulation stop; 0.08 - 0.2 mm² "s" (0.14 mm² "f-st"); 5 pieces/strip; white	www.wago.com/280-470
	Nr. articol: 280-471 Insulation stop; 0.25 - 0.5 mm²; 5 pieces/strip; light gray	www.wago.com/280-471
	Nr. articol: 280-472 Insulation stop; 0.75 - 1 mm²; 5 pieces/strip	www.wago.com/280-472

Carrier rail

	Nr. articol: 210-112 Steel carrier rail; 35 x 7.5 mm; 1 mm thick; 2 m long; slotted; according to EN 60715; "Hole width 25 mm	www.wago.com/210-112
	Nr. articol: 210-113 Steel carrier rail; 35 x 7.5 mm; 1 mm thick; 2 m long; unslotted; according to EN 60715	www.wago.com/210-113
	Nr. articol: 210-114 Steel carrier rail; 35 x 15 mm; 1.5 mm thick; 2 m long; unslotted; similar to EN 60715	www.wago.com/210-114
	Nr. articol: 210-115 Steel carrier rail; 35 x 7.5 mm; 1 mm thick; 2 m long; slotted; according to EN 60715; "Hole width 18 mm	www.wago.com/210-115
	Nr. articol: 210-118 Steel carrier rail; 35 x 15 mm; 2.3 mm thick; 2 m long; unslotted; according to EN 60715	www.wago.com/210-118
	Nr. articol: 210-196 Aluminum carrier rail; 35 x 8.2 mm; 1.6 mm thick; 2 m long; unslotted; similar to EN 60715; silver-colored	www.wago.com/210-196
	Nr. articol: 210-197 Steel carrier rail; 35 x 15 mm; 1.5 mm thick; 2 m long; slotted; similar to EN 60715	www.wago.com/210-197
	Nr. articol: 210-504 Steel carrier rail; 35 x 7.5 mm; 1 mm thick; 2 m long; slotted; galvanized; according to EN 60715	www.wago.com/210-504
	Nr. articol: 210-505 Steel carrier rail; 35 x 7.5 mm; 1 mm thick; 2 m long; unslotted; galvanized; according to EN 60715	www.wago.com/210-505
	Nr. articol: 210-506 Steel carrier rail; 35 x 15 mm; 1.5 mm thick; 2 m long; unslotted; galvanized; similar to EN 60715	www.wago.com/210-506

Supus modificărilor.

**Nr. articol: 210-508**

Steel carrier rail; 35 x 15 mm; 1.5 mm thick; 2 m long; slotted; galvanized; similar to EN 60715

www.wago.com/210-508**General accessories****Nr. articol: 870-182**

Adaptor; gray

www.wago.com/870-182**Nr. articol: 870-183**

Adaptor; gray

www.wago.com/870-183**Nr. articol: 870-184**

Adaptor; gray

www.wago.com/870-184**Nr. articol: 870-425**

Tap-off module; with anti-rotation protection; modular; suitable for 870 Series terminal blocks with jumper slots in the current bar; gray

www.wago.com/870-425**Nr. articol: 870-426**

Tap-off module; modular; suitable for 870 Series terminal blocks with jumper slots in the current bar; gray

www.wago.com/870-426**Nr. articol: 870-427**

Spacer module; modular; bridging commoned terminal blocks; gray

www.wago.com/870-427**Descărcări****Documentation****Additional Information**

Technical explanations

Apr 3, 2019

pdf
2,1 MB

Descărcare

CAD/CAE-Data**CAD data**

2D/3D Models 870-904

URL

Descărcare

CAE data

EPLAN Data Portal 870-904

URL

Descărcare

WSCAD Universe 870-904

URL

Descărcare

Installation Notes**Assembly**

Supus modificărilor.

WAGO Kontakttechnik GmbH & Co. KG
/Representative Office Romania
Sos. Pipera-Tunari nr. 1/1
building 1, 2nd floor | 077190 Voluntari, Ilfov
Tel.: +40-(0)31 421 85 68 | Email: info-RO@wago.com

Aveți întrebări despre produsele noastre?
Vă stăm la dispoziție pentru preluarea apelului la +40 (0) 31 421 85 68.

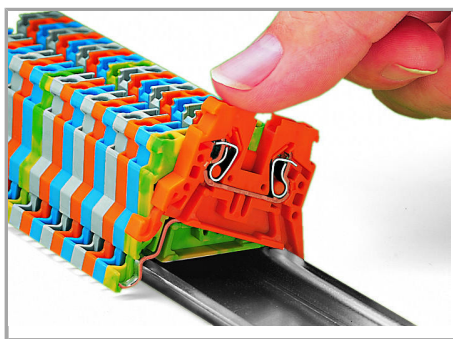

Snapping a rail-mount terminal block onto DIN-35 rail.

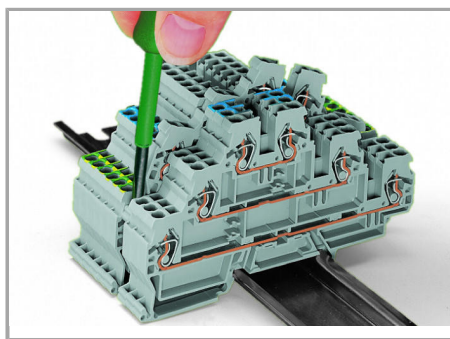

Removing a terminal block from the assembly.

Inserting a conductor

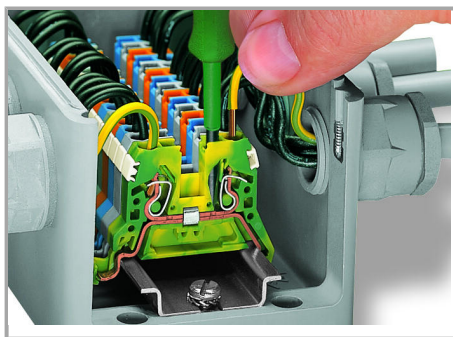

CAGE CLAMP® connection

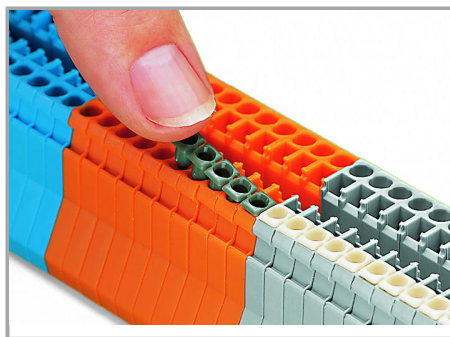

Inserting an insulation stop into conductor entry holes of terminal strip.

Inserting a conductor (0.08 ... 4 mm² "f-st").

With ferruled conductors, it is necessary to use a terminal block one size smaller than the conductor's nominal cross section.

Jumpered

Supus modificărilor.



Push jumper bars down firmly until fully inserted. When using multipole bars, push alternately on the right and then left side, until installed.

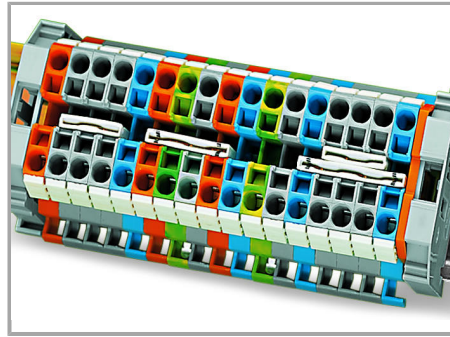

Commoning with push-in type jumper bars:

Two parallel jumper slots are accommodated in one terminal block.



Commoning terminal blocks of different sizes via step-down jumpers.

Push-in type jumper bars 1 – 3 – 5 – 7 or 1 – – 4 – – 7

upon request

Testing

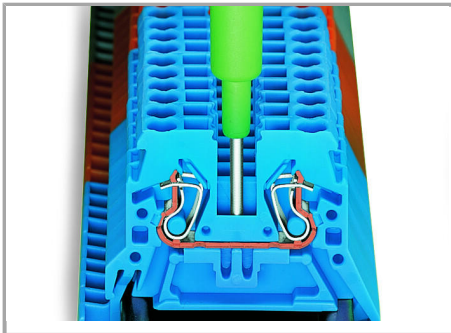

Testing with phase testing device, also possible with single-pole voltage tester.

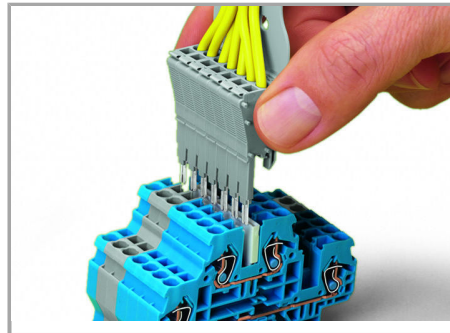

Testing is also possible using a pre-wired tap-off module assembly in the very same way as test plugs.

Cover

Supus modificărilor.

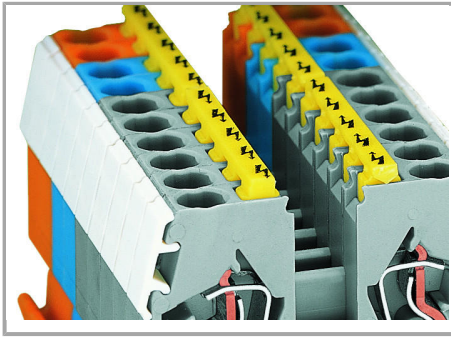

Protective warning markers (280-405), with a black high-voltage symbol

Marking

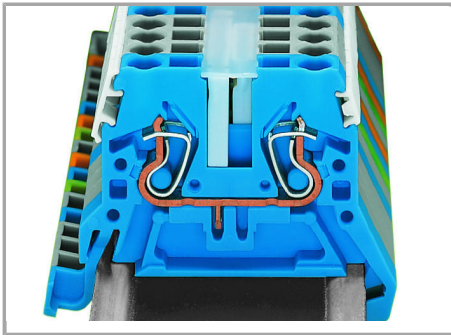

WMB markers in Mini-WSB marker slots

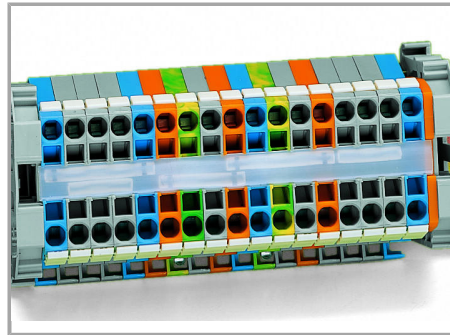

Translucent marking strip (709-196) – jumpers below may be visible.

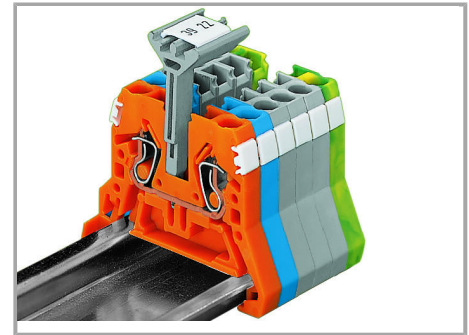

In addition to the plastic marker strips, group marker carriers are now available for the WMB and WSB marking systems. They can be mounted parallel to a push-in type jumper bar via open jumper contact slot. It assists with viewing marker slots on the side of the terminal block. Group marker carriers are available in 5 mm/0.197 inch, 10 mm/0.394 inch and 15 mm/0.591 inch widths.

Marking strip, translucent

Mini-WSB markers

Notice:

Marker carriers are not suitable for ground conductor terminal blocks and double-potential terminal blocks as they have no jumper contact slots.

Supus modificărilor.