

Fișă tehnică | Număr articol: 283-904

2-conductor through terminal block; 16 mm²; center marking; for DIN-rail 35 x 15 and 35 x 7.5; CAGE CLAMP®; 16,00 mm²; blue

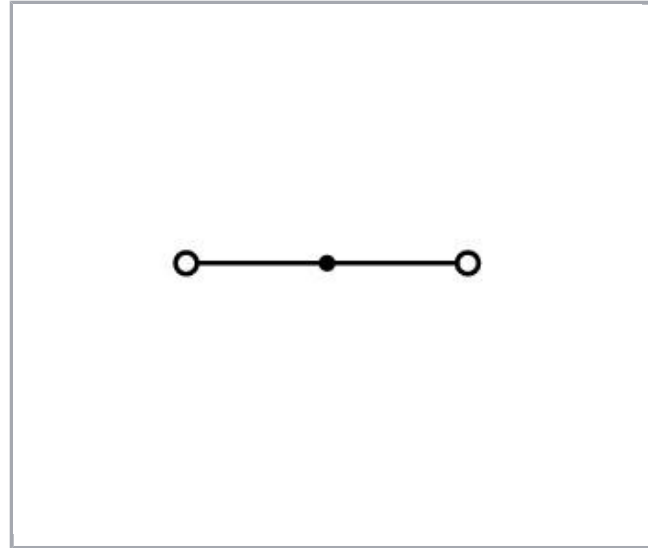

www.wago.com/283-904

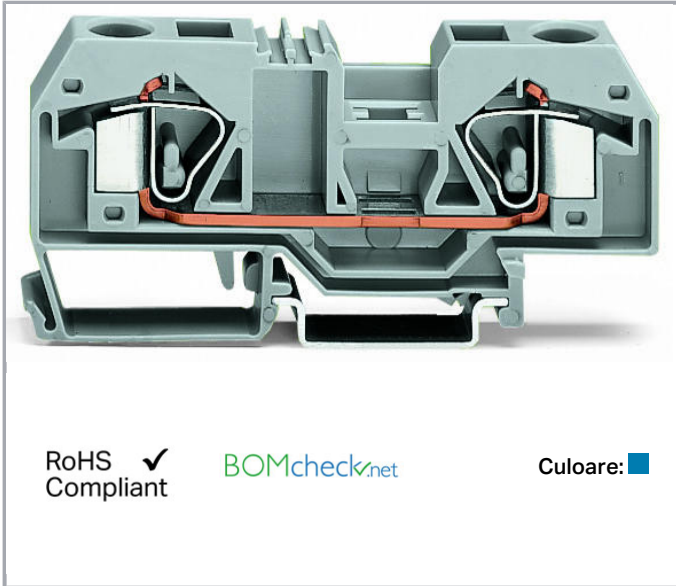

Date

Electrical data

Ratings per IEC/EN 60664-1

| Ratings per | IEC/EN 60947-7-1 |
|-----------------------------|---|
| Nominal voltage (III/3) | 800 V |
| Rated surge voltage (III/3) | 8 kV |
| Rated current | 76 A |
| Legend (ratings) | (III / 3) ≙ Overvoltage category III / Pollution degree 3 |

Connection data

| | |
|-----------------------------------|---|
| Connection technology | CAGE CLAMP® |
| Actuation type | Operating tool |
| Connectable conductor materials | Copper |
| Solid conductor | 0,2 ... 16 mm ² / 24 ... 6 AWG |
| Fine-stranded conductor | 0,2 ... 16 mm ² / 24 ... 6 AWG |
| Strip length | 16 ... 17 mm / 0.63 ... 0.67 inch |
| Total number of connection points | 2 |

Supus modificărilor.

WAGO Kontakttechnik GmbH & Co. KG
/Representative Office Romania
Sos. Pipera-Tunari nr. 1/1
building 1, 2nd floor | 077190 Voluntari, Ilfov
Tel.: +40-(0)31 421 85 68 | Email: info-RO@wago.com

Aveți întrebări despre produsele noastre?
Vă stăm la dispoziție pentru preluarea apelului la +40 (0) 31 421 85 68.



| | |
|----------------------------|--------------------|
| Total number of potentials | 1 |
| Number of levels | 1 |
| Wiring type | Front-entry wiring |

Geometrical Data

| | |
|------------------------------------|----------------------|
| Width | 12 mm / 0.472 inch |
| Height from upper-edge of DIN-rail | 37,5 mm / 1.476 inch |
| Depth | 94,5 mm / 3.72 inch |

Mechanical data

| | |
|---------------|-----------------|
| Design | horizontal type |
| Mounting type | DIN-35 rail |
| Marking level | Center marking |

Material Data

| | |
|---------------------|----------------------|
| Color | blue |
| Insulation material | Polyamide 66 (PA 66) |
| Fire load | 0,536 MJ |
| Weight | 35,7 g |

Commercial data

| | |
|-----------------------|----------------------------------|
| Product Group | 1 (Rail Mounted Terminal Blocks) |
| Packaging type | BOX |
| Country of origin | DE |
| GTIN | 4044918297875 |
| Customs tariff number | 85369010000 |

Aprobări / certificate**Country specific Approvals**

| Emblemă | Aprobare | Text de aprobare suplimentar | Nume certificat |
|--|---------------------------------|------------------------------|--------------------|
|  | CCA DEKRA Certification B.V. | EN 60947 | NTR NL- 7456/A1 |
| | CSA DEKRA Certification B.V. | C22.2 No. 158 | 1536072 |

Supus modificărilor.

WAGO Kontakttechnik GmbH & Co. KG
/Representative Office Romania
Sos. Pipera-Tunari nr. 1/1
building 1, 2nd floor | 077190 Voluntari, Ilfov
Tel.: +40-(0)31 421 85 68 | Email: info-RO@wago.com

Aveți întrebări despre produsele noastre?
Vă stăm la dispoziție pentru preluarea apelului la +40 (0) 31 421 85 68.







KEMA/KEUR
DEKRA Certification B.V.

EN 60947

2187239.03

Ship Approvals

| Emblemă | Aprobare | Text de aprobare suplimentar | Nume certificat |
|---|---|------------------------------|--------------------------|
|  | ABS American Bureau of Shipping | - | 20- HG1941090- PDA |
|  | BV Bureau Veritas S.A. | EN 60947 | 07436/E0 BV |
|  | DNV GL Det Norske Veritas, Germanischer Lloyd | - | TAE00001V2 |
|  | LR Lloyds Register | EN 60947 | 91/20112 (E9) |

UL-Approvals

| Emblemă | Aprobare | Text de aprobare suplimentar | Nume certificat |
|--|--|------------------------------|---------------------|
|  | UL UL International Germany GmbH | UL 1059 | 20190731- E45172 |

Counterpart







Produse compatibile

Supus modificărilor.





WAGO Kontakttechnik GmbH & Co. KG
/Representative Office Romania
Sos. Pipera-Tunari nr. 1/1
building 1, 2nd floor | 077190 Voluntari, Ilfov
Tel.: +40-(0)31 421 85 68 | Email: info-RO@wago.com

Aveți întrebări despre produsele noastre?
Vă stăm la dispoziție pentru preluarea apelului la +40 (0) 31 421 85 68.



End plate

| | | |
|---|---|--|
|  | Nr. articol: 283-325 End and intermediate plate; 2.5 mm thick; gray | www.wago.com/283-325 |
|  | Nr. articol: 283-326 Separator plate; 2 mm thick; oversized; gray | www.wago.com/283-326 |
|  | Nr. articol: 283-328 End and intermediate plate; 2.5 mm thick; orange | www.wago.com/283-328 |
|  | Nr. articol: 283-329 Separator plate; 2 mm thick; oversized; orange | www.wago.com/283-329 |
|  | Nr. articol: 283-357 Step-down cover plate; 1 mm thick; only for 2-conductor 283-901 terminal block; gray | www.wago.com/283-357 |
|  | Nr. articol: 283-367 Step-down cover plate; 1 mm thick; only for 2-conductor 283-901 terminal block; orange | www.wago.com/283-367 |















Jumper

| | | |
|--|---|--|
|  | Nr. articol: 283-402 Adjacent jumper; insulated; Nominal current 70 A; gray | www.wago.com/283-402 |
|  | Nr. articol: 283-409 Alternate jumper; insulated; Nominal current 76 A; gray | www.wago.com/283-409 |
|  | Nr. articol: 283-414 Step-down jumper; insulated; from 16 mm ² to 4 mm ² ; Nominal current 32 A; gray | www.wago.com/283-414 |
|  | Nr. articol: 283-422 Adjacent jumper; insulated; Nominal current 70 A; yellow-green | www.wago.com/283-422 |
|  | Nr. articol: 285-435 Adjacent jumper; insulated; Nominal current 85 A; gray | www.wago.com/285-435 |

ferrule

| | | |
|--|--|--|
|  | Nr. articol: 216-108 Ferrule; Sleeve for 6 mm ² / AWG 10; uninsulated; electro-tin plated | www.wago.com/216-108 |
|  | Nr. articol: 216-109 Ferrule; Sleeve for 10 mm ² / AWG 8; uninsulated; electro-tin plated | www.wago.com/216-109 |
| | Nr. articol: 216-284 | |

Supus modificărilor.

| | | |
|--|--|--|
|  | Ferrule; Sleeve for 1.5 mm ² / AWG 16; insulated; electro-tin plated; electrolytic copper; gastight crimped; acc. to DIN 46228, Part 4/09.90; black | www.wago.com/216-284 |
|  | Nr. articol: 216-286 Ferrule; Sleeve for 2.5 mm ² / AWG 14; insulated; electro-tin plated; electrolytic copper; gastight crimped; acc. to DIN 46228, Part 4/09.90; blue | www.wago.com/216-286 |
|  | Nr. articol: 216-287 Ferrule; Sleeve for 4 mm ² / AWG 12; insulated; electro-tin plated; electrolytic copper; gastight crimped; acc. to DIN 46228, Part 4/09.90; gray | www.wago.com/216-287 |
|  | Nr. articol: 216-288 Ferrule; Sleeve for 6 mm ² / AWG 10; insulated; electro-tin plated; electrolytic copper; gastight crimped; acc. to DIN 46228, Part 4/09.90; yellow | www.wago.com/216-288 |
|  | Nr. articol: 216-289 Ferrule; Sleeve for 10 mm ² / AWG 8; insulated; electro-tin plated; electrolytic copper; gastight crimped; acc. to DIN 46228, Part 4/09.90; red | www.wago.com/216-289 |
| assembling | | |
|  | Nr. articol: 209-106 Mounting carrier; for isolated mounting on DIN 35 rails; gray | www.wago.com/209-106 |
|  | Nr. articol: 709-154 Cover; Type 2; suitable for cover carrier, type 2; 1 m long; transparent | www.wago.com/709-154 |
| potential distribution | | |
|  | Nr. articol: 283-407 Power tap; with 500 mm cable; for 16 mm ² (283/783 Series) and 35 mm ² ; gray | www.wago.com/283-407 |
| protection | | |
|  | Nr. articol: 283-400 Finger guard; touchproof cover protects unused conductor entries; yellow | www.wago.com/283-400 |
| tools | | |
|  | Nr. articol: 210-721 Operating tool; Blade: 5.5 x 0.8 mm; with a partially insulated shaft | www.wago.com/210-721 |
| check | | |
|  | Nr. articol: 283-404 Test plug adapter; 11.6 mm wide; for 4 mm Ø test plugs; gray | www.wago.com/283-404 |
| Protective Warning Marker | | |
|  | Nr. articol: 283-415 Protective warning marker; with high-voltage symbol, black; for 5 terminal blocks; yellow | www.wago.com/283-415 |
| Carrier rail | | |
|  | Nr. articol: 210-112 Steel carrier rail; 35 x 7.5 mm; 1 mm thick; 2 m long; slotted; according to EN 60715; "Hole width 25 mm | www.wago.com/210-112 |
|  | Nr. articol: 210-113 Steel carrier rail; 35 x 7.5 mm; 1 mm thick; 2 m long; unslotted; according to EN 60715 | www.wago.com/210-113 |
| | Nr. articol: 210-114 Steel carrier rail; 35 x 15 mm; 1.5 mm thick; 2 m long; unslotted; similar to EN 60715 | www.wago.com/210-114 |

Supus modificărilor.

**Nr. articol: 210-115**

Steel carrier rail; 35 x 7.5 mm; 1 mm thick; 2 m long; slotted; according to EN 60715; "Hole width 18 mm

www.wago.com/210-115**Nr. articol: 210-118**

Steel carrier rail; 35 x 15 mm; 2.3 mm thick; 2 m long; unslotted; according to EN 60715

www.wago.com/210-118**Nr. articol: 210-196**

Aluminum carrier rail; 35 x 8.2 mm; 1.6 mm thick; 2 m long; unslotted; similar to EN 60715; silver-colored

www.wago.com/210-196**Nr. articol: 210-197**

Steel carrier rail; 35 x 15 mm; 1.5 mm thick; 2 m long; slotted; similar to EN 60715

www.wago.com/210-197**Nr. articol: 210-198**

Copper carrier rail; 35 x 15 mm; 2.3 mm thick; 2 m long; unslotted; according to EN 60715; copper-colored

www.wago.com/210-198**Nr. articol: 210-504**

Steel carrier rail; 35 x 7.5 mm; 1 mm thick; 2 m long; slotted; galvanized; according to EN 60715

www.wago.com/210-504**Nr. articol: 210-505**

Steel carrier rail; 35 x 7.5 mm; 1 mm thick; 2 m long; unslotted; galvanized; according to EN 60715

www.wago.com/210-505**Nr. articol: 210-506**

Steel carrier rail; 35 x 15 mm; 1.5 mm thick; 2 m long; unslotted; galvanized; similar to EN 60715

www.wago.com/210-506**Nr. articol: 210-508**

Steel carrier rail; 35 x 15 mm; 1.5 mm thick; 2 m long; slotted; galvanized; similar to EN 60715

www.wago.com/210-508**Marking accessories****Nr. articol: 2009-115**

WMB-Inline; for Smart Printer; 1500 pieces on roll; stretchable 5 - 5.2 mm; plain; snap-on type; white

www.wago.com/2009-115**Nr. articol: 2009-115/000-002**

WMB-Inline; for Smart Printer; 1500 pieces on roll; stretchable 5 - 5.2 mm; plain; snap-on type; yellow

www.wago.com/2009-115/000-002**Nr. articol: 2009-115/000-006**

WMB-Inline; for Smart Printer; 1500 pieces on roll; stretchable 5 - 5.2 mm; plain; snap-on type; blue

www.wago.com/2009-115/000-006**Nr. articol: 2009-115/000-007**

WMB-Inline; for Smart Printer; 1500 pieces on roll; stretchable 5 - 5.2 mm; plain; snap-on type; gray

www.wago.com/2009-115/000-007**Nr. articol: 2009-115/000-012**















WMB-Inline; for Smart Printer; 1500 pieces on roll; stretchable 5 - 5.2 mm; plain; snap-on type; orange

www.wago.com/2009-115/000-012**Nr. articol: 2009-115/000-017**

WMB-Inline; for Smart Printer; 1500 pieces on roll; stretchable 5 - 5.2 mm; plain; snap-on type; light green

www.wago.com/2009-115/000-017

Supus modificărilor.

| | | |
|--|---|--|
|  | Nr. articol: 2009-115/000-023 WMB-Inline; for Smart Printer; 1500 pieces on roll; stretchable 5 - 5.2 mm; plain; snap-on type; green | www.wago.com/2009-115/000-023 |
|  | Nr. articol: 2009-115/000-024 WMB-Inline; for Smart Printer; 1500 pieces on roll; stretchable 5 - 5.2 mm; plain; snap-on type; violet | www.wago.com/2009-115/000-024 |
|  | Nr. articol: 209-185 Adaptor; gray | www.wago.com/209-185 |
|  | Nr. articol: 249-105 Group marker carrier; gray | www.wago.com/249-105 |
|  | Nr. articol: 793-501 WMB marking card; as card; not stretchable; plain; snap-on type; white | www.wago.com/793-501 |
|  | Nr. articol: 793-501/000-002 WMB marking card; as card; not stretchable; plain; snap-on type; yellow | www.wago.com/793-501/000-002 |
|  | Nr. articol: 793-501/000-005 WMB marking card; as card; not stretchable; plain; snap-on type; red | www.wago.com/793-501/000-005 |
|  | Nr. articol: 793-501/000-006 WMB marking card; as card; not stretchable; plain; snap-on type; blue | www.wago.com/793-501/000-006 |
|  | Nr. articol: 793-501/000-007 WMB marking card; as card; not stretchable; plain; snap-on type; gray | www.wago.com/793-501/000-007 |
|  | Nr. articol: 793-501/000-012 WMB marking card; as card; not stretchable; plain; snap-on type; orange | www.wago.com/793-501/000-012 |
|  | Nr. articol: 793-501/000-017 WMB marking card; as card; not stretchable; plain; snap-on type; light green | www.wago.com/793-501/000-017 |
|  | Nr. articol: 793-501/000-023 WMB marking card; as card; not stretchable; plain; snap-on type; green | www.wago.com/793-501/000-023 |
|  | Nr. articol: 793-501/000-024 WMB marking card; as card; not stretchable; plain; snap-on type; violet | www.wago.com/793-501/000-024 |
|  | Nr. articol: 793-5501 WMB marking card; as card; for terminal block width 5 - 17.5 mm; stretchable 5 - 5.2 mm; plain; snap-on type; white | www.wago.com/793-5501 |
| | Nr. articol: 793-5501/000-002 | |

Supus modificărilor.



WMB marking card; as card; for terminal block width 5 - 17.5 mm; stretchable 5 - 5.2 mm; plain; snap-on type; yellow www.wago.com/793-5501/000-002



Nr. articol: 793-5501/000-005
WMB marking card; as card; for terminal block width 5 - 17.5 mm; stretchable 5 - 5.2 mm; plain; snap-on type; red www.wago.com/793-5501/000-005



Nr. articol: 793-5501/000-006
WMB marking card; as card; for terminal block width 5 - 17.5 mm; stretchable 5 - 5.2 mm; plain; snap-on type; blue www.wago.com/793-5501/000-006



Nr. articol: 793-5501/000-007
WMB marking card; as card; for terminal block width 5 - 17.5 mm; stretchable 5 - 5.2 mm; plain; snap-on type; gray www.wago.com/793-5501/000-007



Nr. articol: 793-5501/000-012
WMB marking card; as card; for terminal block width 5 - 17.5 mm; stretchable 5 - 5.2 mm; plain; snap-on type; orange www.wago.com/793-5501/000-012



Nr. articol: 793-5501/000-017
WMB marking card; as card; for terminal block width 5 - 17.5 mm; stretchable 5 - 5.2 mm; plain; snap-on type; green www.wago.com/793-5501/000-017



Nr. articol: 793-5501/000-023
WMB marking card; as card; for terminal block width 5 - 17.5 mm; stretchable 5 - 5.2 mm; plain; snap-on type; light green www.wago.com/793-5501/000-023



Nr. articol: 793-5501/000-024
WMB marking card; as card; for terminal block width 5 - 17.5 mm; stretchable 5 - 5.2 mm; plain; snap-on type; violet www.wago.com/793-5501/000-024

Descărcări

Documentation

Additional Information

| | | | |
|------------------------|-------------|---------------|------------|
| Technical explanations | Apr 3, 2019 | pdf 2,1 MB | Descărcare |
|------------------------|-------------|---------------|------------|

CAD/CAE-Data

CAD data

| | | |
|----------------------|-----|------------|
| 2D/3D Models 283-904 | URL | Descărcare |
|----------------------|-----|------------|

CAE data

| | | |
|---------------------------|-----|------------|
| EPLAN Data Portal 283-904 | URL | Descărcare |
|---------------------------|-----|------------|

W3CAD | Inversor 283-904

Supus modificărilor.

WAGO Kontakttechnik GmbH & Co. KG
/Representative Office Romania
Sos. Pipera-Tunari nr. 1/1
building 1, 2nd floor | 077190 Voluntari, Ilfov
Tel.: +40-(0)31 421 85 68 | Email: info-RO@wago.com

Aveți întrebări despre produsele noastre?
Vă stăm la dispoziție pentru preluarea apelului la +40 (0) 31 421 85 68.

Installation Notes

Assembly

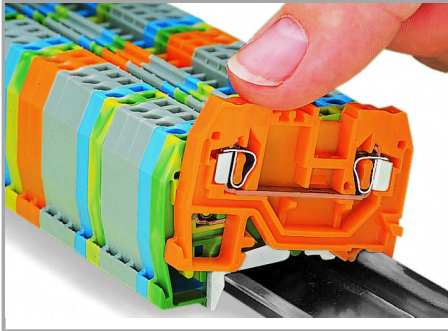

Snapping a terminal block onto the carrier rail.

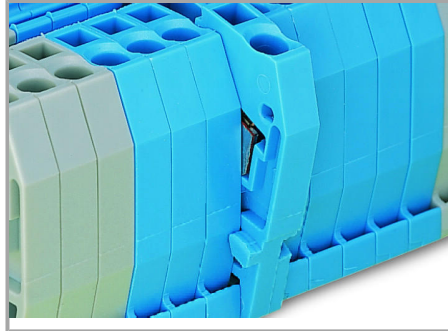

Quick assembly keys prevent reverse mounting.



Removing a terminal block from the assembly.

Inserting a conductor

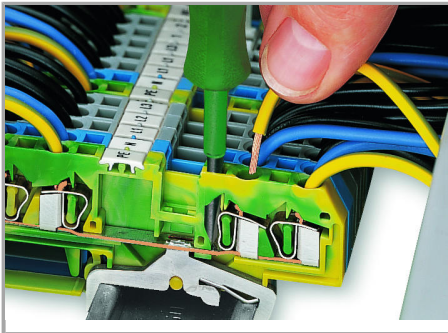

CAGE CLAMP® connection

Inserting a conductor.

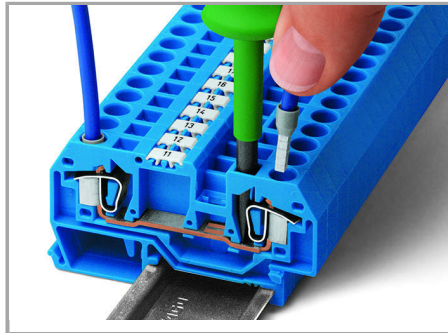

CAGE CLAMP® connection

Inserting a conductor.

With ferruled conductors, it is necessary to use a terminal block one size larger than the conductor's nominal cross-section.

Commoning

Supus modificărilor.

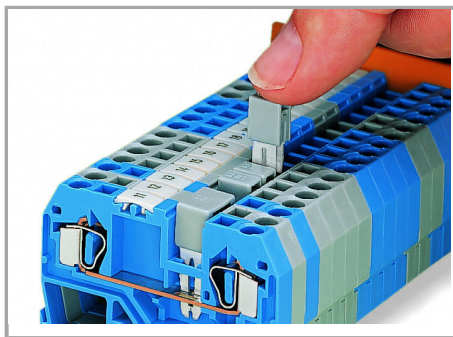

Commoning using an adjacent jumper (280-402).

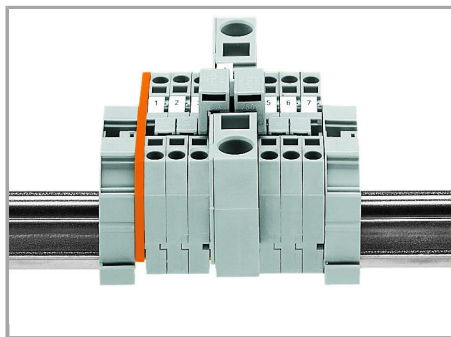

Commoning from 16 mm²/6 AWG (283 Series) to 4 mm²/12 AWG (281 Series) rail-mount terminal blocks via step-down jumpers.

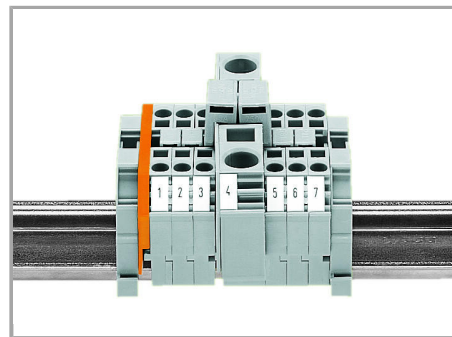

Commoning from 16 mm²/6 AWG (283 Series) to 4 mm²/12 AWG (281 Series) rail-mount terminal blocks via step-down jumpers.

Push jumper down until fully inserted.

Cover

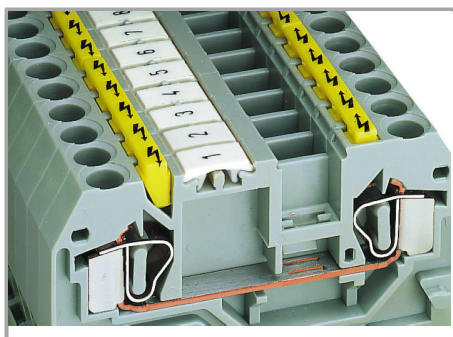

Protective warning markers inserted into the operating slots.

Marking

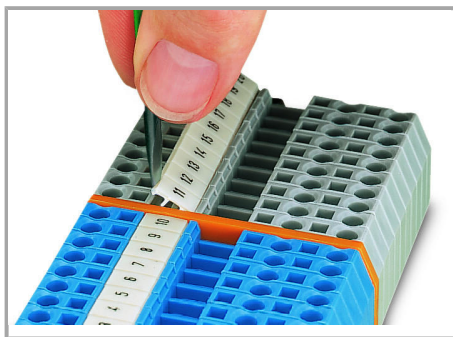

Marking via WMB Multi Marking System.

Supus modificărilor.