

Fișă tehnică | Număr articol: 2092-1132

1-conductor female plug; 2.5 mm<sup>2</sup>; Pin spacing 5 mm; 12-pole; 2,50 mm<sup>2</sup>;  
light gray

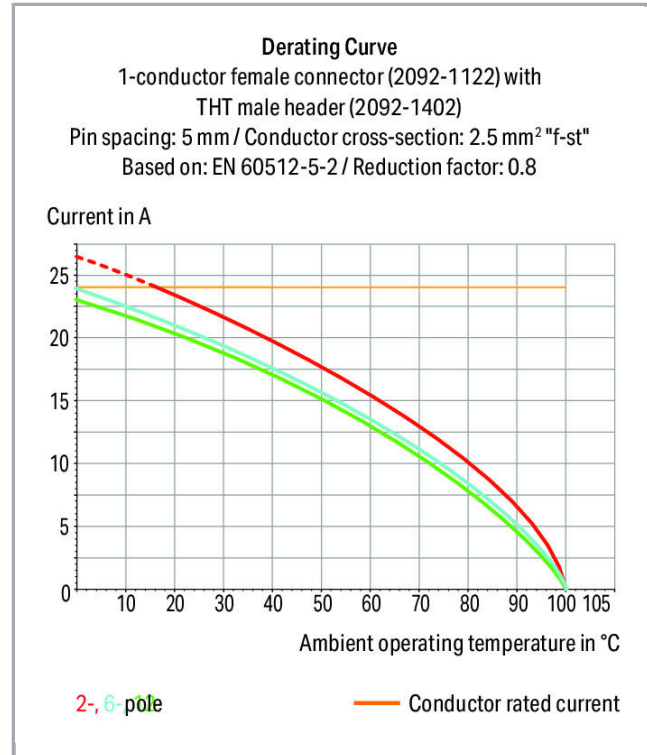

[www.wago.com/2092-1132](http://www.wago.com/2092-1132)



Supus modificărilor.

WAGO Kontakttechnik GmbH & Co. KG  
/Representative Office Romania  
Sos. Pipera-Tunari nr. 1/1  
building 1, 2nd floor | 077190 Voluntari, Ilfov  
Tel.: +40-(0)31 421 85 68 | Email: info-RO@wago.com

Aveți întrebări despre produsele noastre?  
Vă stăm la dispoziție pentru preluarea apelului la +40 (0) 31 421 85 68.

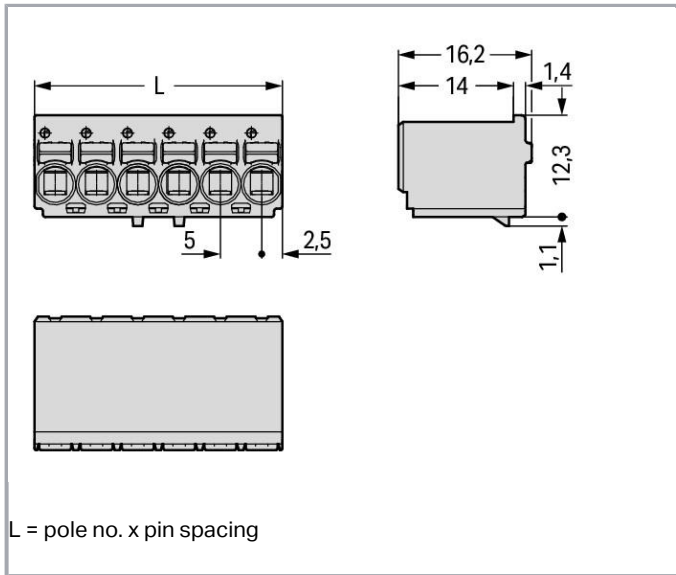

## Descriere articol

- Universal connection of all conductor types
- Simple, push-in termination of solid and ferruled conductors
- Easy-to-use design does not require special tools
- Ability to wire while mated or unmated
- Testing parallel to conductor entry – tip contact
- Also available with gripping plates
- Integrated locking latches prevent accidental disconnection

### Safety information 1:

The **picoMAX® pluggable connection system** is designed without breaking capacity for compliance with DIN EN 61984. When used as intended, MCS Connectors shall not be connected/disconnected when live or under load. The circuit design should ensure header pins, which can be touched, are not live when unmated.

## Date

### Electrical data

#### Ratings per IEC/EN 60664-1

Ratings per	IEC/EN 60664-1
Nominal voltage (III/3)	250 V
Rated surge voltage (III/3)	4 kV
Rated voltage (III/2)	320 V

Supus modificărilor.

WAGO Kontakttechnik GmbH & Co. KG  
 /Representative Office Romania  
 Sos. Pipera-Tunari nr. 1/1  
 building 1, 2nd floor | 077190 Voluntari, Ilfov  
 Tel.: +40-(0)31 421 85 68 | Email: info-RO@wago.com

Aveți întrebări despre produsele noastre?  
 Vă stăm la dispoziție pentru preluarea apelului la +40 (0) 31 421 85 68.



Rated surge voltage (III/2)	4 kV
Nominal voltage (II/2)	630 V
Rated surge voltage (II/2)	4 kV
Rated current	16 A
Legend (ratings)	(III / 2) $\triangleq$ Overvoltage category III / Pollution degree 2

### Approvals per UL 1059

Rated voltage UL (Use Group B)	300 V
Rated current UL (Use Group B)	15 A
Rated voltage UL (Use Group D)	300 V
Rated current UL (Use Group D)	10 A
Approvals per	UL 1059

### Connection data

Connection technology	Push-in CAGE CLAMP <sup>®</sup>
Actuation type	Push-button
Solid conductor	0.2 ... 2.5 mm <sup>2</sup> / 24 ... 12 AWG
Fine-stranded conductor	0.2 ... 2.5 mm <sup>2</sup> / 24 ... 12 AWG
Fine-stranded conductor; with insulated ferrule	0.25 ... 1.5 mm <sup>2</sup>
Fine-stranded conductor; with uninsulated ferrule	0.25 ... 2.5 mm <sup>2</sup>
Strip length	9 ... 10 mm / 0.35 ... 0.39 inch
Pole No.	12
Total number of connection points	12
Total number of potentials	12
Number of connection types	1
Number of levels	1

### Geometrical Data

Pin spacing	5 mm / 0.197 inch
Width	60 mm / 2.362 inch
Height	16.2 mm / 0.638 inch
Depth	13.4 mm / 0.528 inch

### Plug connection

Contact type (pluggable connector)	Female connector/socket
Connector (connection type)	for conductors

Supus modificărilor.

Mismating protection	No
----------------------	----

### Material Data

Color	light gray
Material group	I
Insulation material	Polyphthalamide (PPA GF)
Flammability class per UL94	V0
Clamping spring material	Chrome nickel spring steel (CrNi)
Contact material	Electrolytic copper (E <sub>Cu</sub> )
Contact plating	tin-plated
Fire load	0,262 MJ
Weight	11,1 g

### Environmental Requirements

Limit temperature range	-60 ... +100 °C
-------------------------	-----------------

### Commercial data

Product Group	26 (picoMAX)
Packaging type	BOX
Country of origin	DE
GTIN	4050821163541
Customs tariff number	85366990990

### Aprobări / certificate

#### Country specific Approvals

Emblemă	Aprobare	Text de aprobare suplimentar	Nume certificat
	CSA DEKRA Certification B.V.	C22.2	2362521

#### UL-Approvals

Emblemă	Aprobare	Text de aprobare suplimentar	Nume certificat
	UL Underwriters Laboratories Inc.	UL 1977	20190909- E45171

Supus modificărilor.

## Counterpart

	<b>Nr. articol</b> 2092-1412 THT male header; 1.4 mm Ø solder pin; straight; Pin spacing 5 mm; 12-pole; light gray	<a href="http://www.wago.com/2092-1412">www.wago.com/2092-1412</a>
	<b>Nr. articol</b> 2092-1432 THT male header; 1.4 mm Ø solder pin; angled; Pin spacing 5 mm; 12-pole; light gray	<a href="http://www.wago.com/2092-1432">www.wago.com/2092-1432</a>
	<b>Nr. articol</b> 2092-1412/005-000 THT male header; 1.4 mm Ø solder pin; straight; clamping collar; Pin spacing 5 mm; 12-pole; light gray	<a href="http://www.wago.com/2092-1412/005-000">www.wago.com/2092-1412/005-000</a>
	<b>Nr. articol</b> 2092-1412/200-000 THR male header; 1.4 mm Ø solder pin; straight; Pin spacing 5 mm; 12-pole; light gray	<a href="http://www.wago.com/2092-1412/200-000">www.wago.com/2092-1412/200-000</a>
	<b>Nr. articol</b> 2092-1432/200-000 THR male header; 1.4 mm Ø solder pin; angled; Pin spacing 5 mm; 12-pole; light gray	<a href="http://www.wago.com/2092-1432/200-000">www.wago.com/2092-1432/200-000</a>
	<b>Nr. articol</b> 2092-1432/005-000 THT male header; 1.4 mm Ø solder pin; angled; clamping collar; Pin spacing 5 mm; 12-pole; light gray	<a href="http://www.wago.com/2092-1432/005-000">www.wago.com/2092-1432/005-000</a>
	<b>Nr. articol</b> 2092-1712/200-000 Solder pin strip; 1.4 mm Ø solder pin; straight; Pin spacing 5 mm; 12-pole; black	<a href="http://www.wago.com/2092-1712/200-000">www.wago.com/2092-1712/200-000</a>
	<b>Nr. articol</b> 2092-1712 Solder pin strip; 1.4 mm Ø solder pin; straight; Pin spacing 5 mm; 12-pole; black	<a href="http://www.wago.com/2092-1712">www.wago.com/2092-1712</a>
	<b>Nr. articol</b> 2092-1732 Solder pin strip; 1.4 mm Ø solder pin; angled; Pin spacing 5 mm; 12-pole; black	<a href="http://www.wago.com/2092-1732">www.wago.com/2092-1732</a>
	<b>Nr. articol</b> 2092-1732/200-000 Solder pin strip; 1.4 mm Ø solder pin; angled; Pin spacing 5 mm; 12-pole; black	<a href="http://www.wago.com/2092-1732/200-000">www.wago.com/2092-1732/200-000</a>

## Produse compatibile





### Strain relief plate

**Nr. articol:** 2092-1603

Supus modificărilor.

WAGO Kontakttechnik GmbH & Co. KG  
/Representative Office Romania  
Sos. Pipera-Tunari nr. 1/1  
building 1, 2nd floor | 077190 Voluntari, Ilfov  
Tel.: +40-(0)31 421 85 68 | Email: info-RO@wago.com

Aveți întrebări despre produsele noastre?  
Vă stăm la dispoziție pentru preluarea apelului la +40 (0) 31 421 85 68.

	Gripping plate; light gray	<a href="http://www.wago.com/2092-1603">www.wago.com/2092-1603</a>
	Nr. articol: 2092-1603/002-000 Gripping plate with sliding connector release; light gray	<a href="http://www.wago.com/2092-1603/002-000">www.wago.com/2092-1603/002-000</a>
<b>check</b>		
	Nr. articol: 735-500 Test pin; 1 mm Ø; with solder connection for test wire	<a href="http://www.wago.com/735-500">www.wago.com/735-500</a>
<b>tools</b>		
	Nr. articol: 2092-1630 Unlocking tool; orange	<a href="http://www.wago.com/2092-1630">www.wago.com/2092-1630</a>
	Nr. articol: 210-719 Operating tool; Blade: 2.5 x 0.4 mm; with a partially insulated shaft	<a href="http://www.wago.com/210-719">www.wago.com/210-719</a>

## Descărcări

### Documentation

#### Additional Information

Technical explanations	Apr 3, 2019	pdf 3,6 MB	Descărcare
------------------------	-------------	---------------	------------

### CAD/CAE-Data

#### CAD data

2D/3D Models 2092-1132	URL	Descărcare
------------------------	-----	------------

### Installation Notes

#### Locking lever

Supus modificărilor.

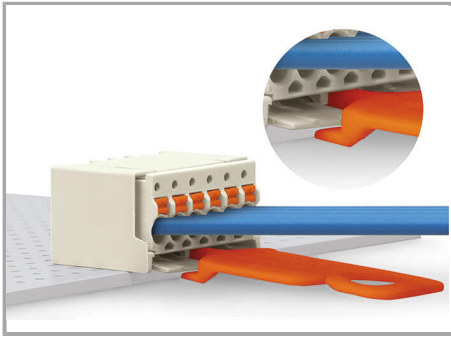

Disconnecting female connector via unlocking tool. Plug unlocking tool into the male header's locking latch.

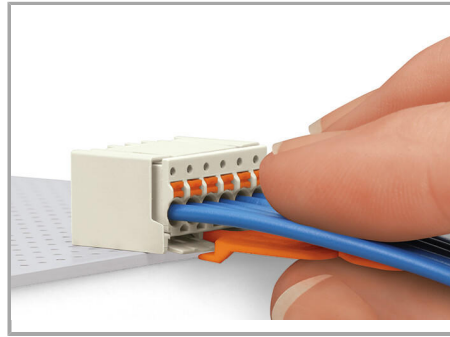

Insert unlocking tool until it hits backstop. Wedge opens locking latch.

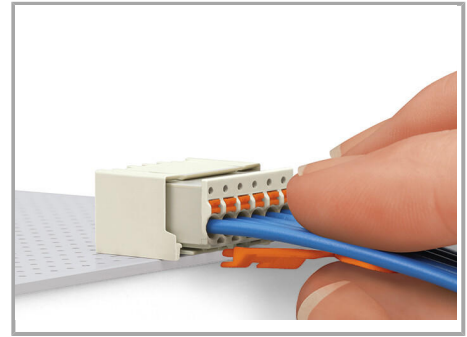

Pull on both unlocking tool and conductors to remove female connector from male header.

### Conductor termination

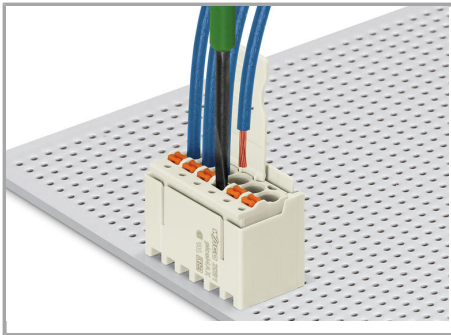

Inserting fine-stranded conductor into mated female connector via push-button.

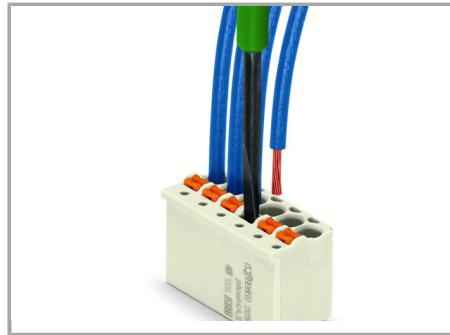

Inserting fine-stranded conductor into unmated female connector via push-button.

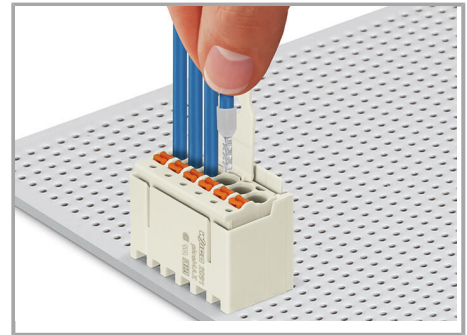

Inserting solid and ferruled conductors via push-in termination

### Marking



Pole marking via factory direct printing.

### Coding

Supus modificărilor.

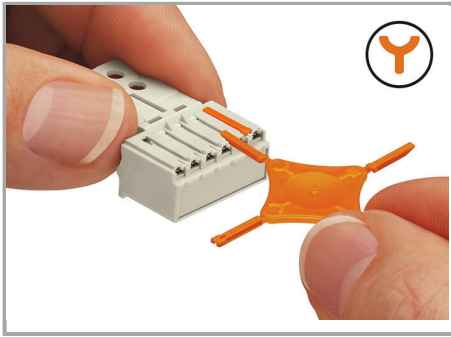

Coding a female connector (via coding key carrier and two keys for female connector, see symbol).

#### Testing

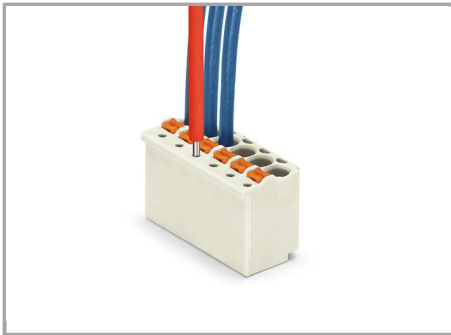

Testing with 1 mm Ø test pin, tip contact.

#### Familie de produse

**picoMAX**

Afișare globală produse din familie.

Supus modificărilor.