

Fișă tehnică | Număr articol: 280-588/280-320

4-conductor sensor terminal block; for PNP (positive) switching sensors; for fuse plugs; with gray end plate; with colored conductor entries; 2.5 mm²; CAGE CLAMP®; 2,50 mm²; gray

www.wago.com/280-588/280-320

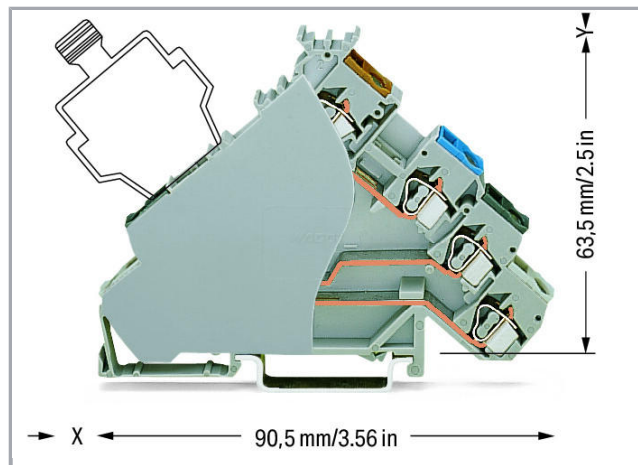

Supus modificărilor.

WAGO Kontakttechnik GmbH & Co. KG
/Representative Office Romania
Sos. Pipera-Tunari nr. 1/1
building 1, 2nd floor | 077190 Voluntari, Ilfov
Tel.: +40-(0)31 421 85 68 | Email: info-RO@wago.com

Aveți întrebări despre produsele noastre?
Vă stăm la dispoziție pentru preluarea apelului la +40 (0) 31 421 85 68.

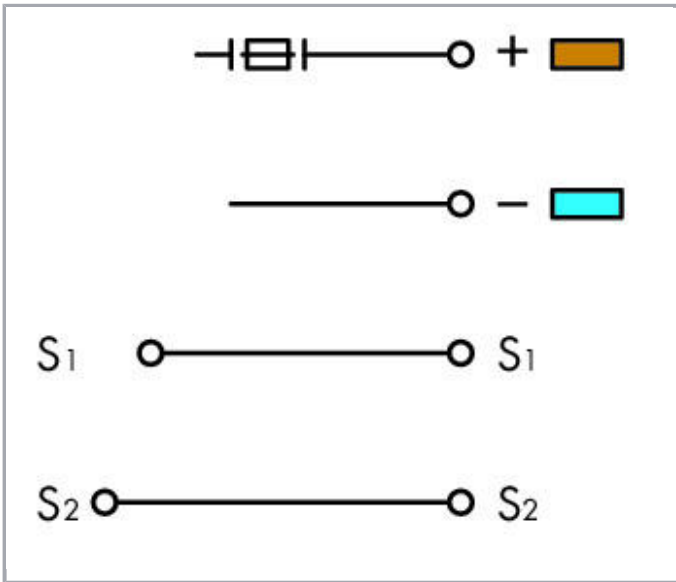

Descriere articol

Note:

Terminating Aluminum Conductors

WAGO spring clamp terminal blocks are suitable for solid aluminum conductors up to 4 mm²/12 AWG if WAGO "Alu-Plus" Contact Paste is used for termination.

"Alu-Plus" Contact Paste Advantages:

- Automatically destroys the oxide film during clamping.
- Prevents fresh oxidation at the clamping point.
- Prevents electrolytic corrosion between aluminum and copper conductors (in the same terminal block).
- Provides long-term protection against corrosion.

Using terminal blocks with CAGE CLAMP® Spring Pressure Connection Technology, **aluminum conductors must first be cleaned with a blade** and then immediately be inserted into the clamping units filled with "Alu-Plus" Contact Paste.

It is also possible to apply WAGO "Alu-Plus" **additionally** on the whole surface of the aluminum conductor before termination.

Please note that the nominal currents must be adapted to the reduced conductivity of the aluminum conductors::

2.5 mm² = 16 A

4 mm² = 22 A

Safety information 1:

Electrical ratings are given by the fuse plug or empty component plug housing.

Date

Electrical data

Supus modificărilor.

**Ratings per IEC/EN 60664-1**

Nominal voltage (III/3)	125 V
Rated current	5 A
Rated voltage (III/3) 2	250 V
Rated current 2	6,3 A
Legend (ratings)	(III / 3) $\hat{=}$ Overvoltage category III / Pollution degree 3

Connection data

Connection technology	CAGE CLAMP®
Actuation type	Operating tool
Connectable conductor materials	Copper Aluminum
Solid conductor	0,08 ... 2,5 mm ² / 28 ... 12 AWG
Fine-stranded conductor	0,08 ... 2,5 mm ² / 28 ... 12 AWG
Strip length	8 ... 9 mm / 0.31 ... 0.35 inch
Total number of connection points	6
Total number of potentials	5
Number of levels	4
Wiring type	Front-entry wiring
Note (conductor cross-section)	12 AWG: THHN, THWN

Geometrical Data

Width	6 mm / 0.236 inch
Height from upper-edge of DIN-rail	63,5 mm / 2.5 inch
Depth	90,5 mm / 3.563 inch

Mechanical data

Design	angled
Mounting type	DIN-35 rail
Marking level	Center marking

Material Data

Color	gray
Insulation material	Polyamide 66 (PA 66)
Fire load	0,348 MJ

Supus modificărilor.

WAGO Kontakttechnik GmbH & Co. KG
 /Representative Office Romania
 Sos. Pipera-Tunari nr. 1/1
 building 1, 2nd floor | 077190 Voluntari, Ilfov
 Tel.: +40-(0)31 421 85 68 | Email: info-RO@wago.com

Aveți întrebări despre produsele noastre?
 Vă stăm la dispoziție pentru preluarea apelului la +40 (0) 31 421 85 68.

Weight	21 g
--------	------

Commercial data

Product Group	1 (Rail Mounted Terminal Blocks)
Packaging type	BOX
Country of origin	DE
GTIN	4045454559489
Customs tariff number	85369010000

Aprobări / certificate

Country specific Approvals

Emblemă	Aprobare	Text de aprobare suplimentar	Nume certificat
	CCA DEKRA Certification B.V.	EN 60947	2160584.53

Ship Approvals

Emblemă	Aprobare	Text de aprobare suplimentar	Nume certificat
	ABS American Bureau of Shipping	EN 60947	20- HG1941090- PDA

UL-Approvals

Emblemă	Aprobare	Text de aprobare suplimentar	Nume certificat
	UR Underwriters Laboratories Inc.	UL 1059	20190731- E45172

Counterpart











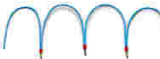



Produse compatibile

Supus modificărilor.

WAGO Kontakttechnik GmbH & Co. KG
/Representative Office Romania
Sos. Pipera-Tunari nr. 1/1
building 1, 2nd floor | 077190 Voluntari, Ilfov
Tel.: +40-(0)31 421 85 68 | Email: info-RO@wago.com

Aveți întrebări despre produsele noastre?
Vă stăm la dispoziție pentru preluarea apelului la +40 (0) 31 421 85 68.

Jumper

	Nr. articol: 210-103 Wire commoning chain; insulated; 50 connections; black	www.wago.com/210-103
	Nr. articol: 210-123 Wire commoning chain; insulated; 50 connections	www.wago.com/210-123
	Nr. articol: 249-123 Push-in type wire jumper; insulated; wire length 180 mm; Conductor cross section 0.75 mm ²	www.wago.com/249-123
	Nr. articol: 249-125 Push-in type wire jumper; insulated; wire length 60 mm; Conductor cross section 0.75 mm ²	www.wago.com/249-125
	Nr. articol: 249-126 Push-in type wire jumper; insulated; wire length 110 mm; Conductor cross section 0.75 mm ²	www.wago.com/249-126
	Nr. articol: 249-127 Push-in type wire jumper; insulated; wire length 250 mm; Conductor cross section 0.75 mm ²	www.wago.com/249-127
	Nr. articol: 280-402 Adjacent jumper; insulated; IN = IN terminal block; gray	www.wago.com/280-402
	Nr. articol: 280-482 Comb-style jumper bar; insulated; 2-way; IN = IN terminal block; gray	www.wago.com/280-482
	Nr. articol: 280-483 Comb-style jumper bar; insulated; 3-way; IN = IN terminal block; gray	www.wago.com/280-483
	Nr. articol: 280-484 Comb-style jumper bar; insulated; 4-way; IN = IN terminal block; gray	www.wago.com/280-484
	Nr. articol: 280-485 Comb-style jumper bar; insulated; 5-way; IN = IN terminal block; gray	www.wago.com/280-485
	Nr. articol: 280-490 Comb-style jumper bar; insulated; 10-way; IN = IN terminal block; gray	www.wago.com/280-490
	Nr. articol: 280-492 Alternate comb-style jumper bar; insulated; 2-way; IN = IN terminal block; gray	www.wago.com/280-492
	Nr. articol: 709-110 Wire commoning chain; insulated; 4 connections; 3 x 110 mm; black	www.wago.com/709-110
	Nr. articol: 709-111 Wire commoning chain; insulated; 3 connections; 2 x 120 mm; black	www.wago.com/709-111

Supus modificărilor.



Nr. articol: 709-112
Wire commoning chain; insulated; 3 connections; 2 x 170 mm; black

www.wago.com/709-112



Nr. articol: 780-452
Staggered jumper; insulated; from 1 to 2; Spacing: 5 mm; suitable for 2-conductor female plugs; gray

www.wago.com/780-452



Nr. articol: 780-453
Staggered jumper; insulated; from 1 to 3; Spacing: 5 mm; suitable for 2-conductor female plugs; gray

www.wago.com/780-453



Nr. articol: 780-454
Staggered jumper; insulated; from 1 to 4; Spacing: 5 mm; suitable for 2-conductor female plugs; gray

www.wago.com/780-454



Nr. articol: 780-455
Staggered jumper; insulated; from 1 to 5; Spacing: 5 mm; suitable for 2-conductor female plugs; gray

www.wago.com/780-455



Nr. articol: 780-456
Staggered jumper; insulated; from 1 to 6; Spacing: 5 mm; suitable for 2-conductor female plugs; gray

www.wago.com/780-456



Nr. articol: 780-457
Staggered jumper; insulated; from 1 to 7; Spacing: 5 mm; suitable for 2-conductor female plugs; gray

www.wago.com/780-457



Nr. articol: 780-458
Staggered jumper; insulated; from 1 to 8; Spacing: 5 mm; suitable for 2-conductor female plugs; gray

www.wago.com/780-458

Carrier rail



Nr. articol: 210-112
Steel carrier rail; 35 x 7.5 mm; 1 mm thick; 2 m long; slotted; according to EN 60715; "Hole width 25 mm

www.wago.com/210-112

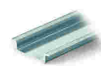

Nr. articol: 210-113
Steel carrier rail; 35 x 7.5 mm; 1 mm thick; 2 m long; unslotted; according to EN 60715

www.wago.com/210-113



Nr. articol: 210-114
Steel carrier rail; 35 x 15 mm; 1.5 mm thick; 2 m long; unslotted; similar to EN 60715

www.wago.com/210-114



Nr. articol: 210-115
Steel carrier rail; 35 x 7.5 mm; 1 mm thick; 2 m long; slotted; according to EN 60715; "Hole width 18 mm

www.wago.com/210-115



Nr. articol: 210-118
Steel carrier rail; 35 x 15 mm; 2.3 mm thick; 2 m long; unslotted; according to EN 60715

www.wago.com/210-118

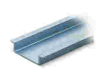

Nr. articol: 210-196
Aluminum carrier rail; 35 x 8.2 mm; 1.6 mm thick; 2 m long; unslotted; similar to EN 60715; silver-colored

www.wago.com/210-196



Nr. articol: 210-197
Steel carrier rail; 35 x 15 mm; 1.5 mm thick; 2 m long; slotted; similar to EN 60715

www.wago.com/210-197



Nr. articol: 210-198
Copper carrier rail; 35 x 15 mm; 2.3 mm thick; 2 m long; unslotted; according to EN 60715; copper-colored

www.wago.com/210-198



Nr. articol: 210-504
Steel carrier rail; 35 x 7.5 mm; 1 mm thick; 2 m long; slotted; galvanized; according to EN 60715

www.wago.com/210-504

Supus modificărilor.

**Nr. articol: 210-505**

Steel carrier rail; 35 x 7.5 mm; 1 mm thick; 2 m long; unslotted; galvanized; according to EN 60715

www.wago.com/210-505**Nr. articol: 210-506**

Steel carrier rail; 35 x 15 mm; 1.5 mm thick; 2 m long; unslotted; galvanized; similar to EN 60715

www.wago.com/210-506**Nr. articol: 210-508**

Steel carrier rail; 35 x 15 mm; 1.5 mm thick; 2 m long; slotted; galvanized; similar to EN 60715

www.wago.com/210-508**Insulation stop****Nr. articol: 280-470**Insulation stop; 0.08 - 0.2 mm² "s" (0.14 mm² "f-st"); 5 pieces/strip; whitewww.wago.com/280-470**Nr. articol: 280-471**Insulation stop; 0.25 - 0.5 mm²; 5 pieces/strip; light graywww.wago.com/280-471**Nr. articol: 280-472**Insulation stop; 0.75 - 1 mm²; 5 pieces/stripwww.wago.com/280-472**Marking accessories****Nr. articol: 2009-115**

WMB-Inline; for Smart Printer; 1500 pieces on roll; stretchable 5 - 5.2 mm; plain; snap-on type; white

www.wago.com/2009-115**Nr. articol: 2009-115/000-002**

WMB-Inline; for Smart Printer; 1500 pieces on roll; stretchable 5 - 5.2 mm; plain; snap-on type; yellow

www.wago.com/2009-115/000-002**Nr. articol: 2009-115/000-006**

WMB-Inline; for Smart Printer; 1500 pieces on roll; stretchable 5 - 5.2 mm; plain; snap-on type; blue

www.wago.com/2009-115/000-006**Nr. articol: 2009-115/000-007**

WMB-Inline; for Smart Printer; 1500 pieces on roll; stretchable 5 - 5.2 mm; plain; snap-on type; gray

www.wago.com/2009-115/000-007**Nr. articol: 2009-115/000-012**

WMB-Inline; for Smart Printer; 1500 pieces on roll; stretchable 5 - 5.2 mm; plain; snap-on type; orange

www.wago.com/2009-115/000-012**Nr. articol: 2009-115/000-017**

WMB-Inline; for Smart Printer; 1500 pieces on roll; stretchable 5 - 5.2 mm; plain; snap-on type; light green

www.wago.com/2009-115/000-017**Nr. articol: 2009-115/000-023**

WMB-Inline; for Smart Printer; 1500 pieces on roll; stretchable 5 - 5.2 mm; plain; snap-on type; green

www.wago.com/2009-115/000-023**Nr. articol: 2009-115/000-024**

WMB-Inline; for Smart Printer; 1500 pieces on roll; stretchable 5 - 5.2 mm; plain; snap-on type; violet

www.wago.com/2009-115/000-024**Nr. articol: 793-501**

WMB marking card; as card; not stretchable; plain; snap-on type; white

www.wago.com/793-501

Supus modificărilor.

WAGO Kontakttechnik GmbH & Co. KG

/Representative Office Romania

Sos. Pipera-Tunari nr. 1/1

building 1, 2nd floor | 077190 Voluntari, Ilfov

Tel.: +40-(0)31 421 85 68 | Email: info-RO@wago.com

Aveți întrebări despre produsele noastre?

Vă stăm la dispoziție pentru preluarea apelului la +40 (0) 31 421 85 68.

**Nr. articol: 793-501/000-002**

WMB marking card; as card; not stretchable; plain; snap-on type; yellow

www.wago.com/793-501/000-002**Nr. articol: 793-501/000-005**

WMB marking card; as card; not stretchable; plain; snap-on type; red

www.wago.com/793-501/000-005**Nr. articol: 793-501/000-006**

WMB marking card; as card; not stretchable; plain; snap-on type; blue

www.wago.com/793-501/000-006**Nr. articol: 793-501/000-007**

WMB marking card; as card; not stretchable; plain; snap-on type; gray

www.wago.com/793-501/000-007**Nr. articol: 793-501/000-012**

WMB marking card; as card; not stretchable; plain; snap-on type; orange

www.wago.com/793-501/000-012**Nr. articol: 793-501/000-017**

WMB marking card; as card; not stretchable; plain; snap-on type; light green

www.wago.com/793-501/000-017**Nr. articol: 793-501/000-023**

WMB marking card; as card; not stretchable; plain; snap-on type; green

www.wago.com/793-501/000-023**Nr. articol: 793-501/000-024**

WMB marking card; as card; not stretchable; plain; snap-on type; violet

www.wago.com/793-501/000-024**Nr. articol: 793-5501**

WMB marking card; as card; for terminal block width 5 - 17.5 mm; stretchable 5 - 5.2 mm; plain; snap-on type; white

www.wago.com/793-5501**Nr. articol: 793-5501/000-002**

WMB marking card; as card; for terminal block width 5 - 17.5 mm; stretchable 5 - 5.2 mm; plain; snap-on type; yellow

www.wago.com/793-5501/000-002**Nr. articol: 793-5501/000-005**

WMB marking card; as card; for terminal block width 5 - 17.5 mm; stretchable 5 - 5.2 mm; plain; snap-on type; red

www.wago.com/793-5501/000-005**Nr. articol: 793-5501/000-006**

WMB marking card; as card; for terminal block width 5 - 17.5 mm; stretchable 5 - 5.2 mm; plain; snap-on type; blue

www.wago.com/793-5501/000-006**Nr. articol: 793-5501/000-007**

WMB marking card; as card; for terminal block width 5 - 17.5 mm; stretchable 5 - 5.2 mm; plain; snap-on type; gray

www.wago.com/793-5501/000-007**Nr. articol: 793-5501/000-012**

Supus modificărilor.



WMB marking card; as card; for terminal block width 5 - 17.5 mm; stretchable 5 - 5.2 mm; plain; snap-on type; orange

www.wago.com/793-5501/000-012



Nr. articol: 793-5501/000-017

WMB marking card; as card; for terminal block width 5 - 17.5 mm; stretchable 5 - 5.2 mm; plain; snap-on type; green

www.wago.com/793-5501/000-017



Nr. articol: 793-5501/000-023

WMB marking card; as card; for terminal block width 5 - 17.5 mm; stretchable 5 - 5.2 mm; plain; snap-on type; light green

www.wago.com/793-5501/000-023



Nr. articol: 793-5501/000-024

WMB marking card; as card; for terminal block width 5 - 17.5 mm; stretchable 5 - 5.2 mm; plain; snap-on type; violet

www.wago.com/793-5501/000-024

tools



Nr. articol: 210-657

Operating tool; Blade: 3.5 x 0.5 mm; with a partially insulated shaft; short

www.wago.com/210-657



Nr. articol: 210-658

Operating tool; Blade: 3.5 x 0.5 mm; with a partially insulated shaft; angled; short

www.wago.com/210-658



Nr. articol: 210-720

Operating tool; Blade: 3.5 x 0.5 mm; with a partially insulated shaft

www.wago.com/210-720

Protective Warning Marker



Nr. articol: 280-415

Protective warning marker; with high-voltage symbol, black; for 5 terminal blocks; yellow

www.wago.com/280-415

plug



Nr. articol: 280-801

Empty component plug housing; gray

www.wago.com/280-801



Nr. articol: 280-850

Fuse plug; with soldered miniature fuse; 250 mA FF; 5 mm wide; gray

www.wago.com/280-850



Nr. articol: 280-850/281-413

Fuse plug; with soldered miniature fuse; with indicator lamp; LED (red); DC 15 - 30 V; 250 mA FF; 5 mm wide; gray

www.wago.com/280-850/281-413



Nr. articol: 280-850/281-414

Fuse plug; with soldered miniature fuse; with indicator lamp; LED (red); DC 30 - 65 V; 250 mA FF; 5 mm wide; gray

www.wago.com/280-850/281-414



Nr. articol: 280-850/281-415

Fuse plug; with soldered miniature fuse; with indicator lamp; LED (red); AC 15 - 30 V; 250 mA FF; 5 mm wide; gray

www.wago.com/280-850/281-415

















Nr. articol: 280-852

Fuse plug; with soldered miniature fuse; 500 mA FF; 5 mm wide; gray

www.wago.com/280-852

Nr. articol: 280-852/281-413

Supus modificărilor.

	Fuse plug; with soldered miniature fuse; with indicator lamp; LED (red); DC 15 - 30 V; 500 mA FF; 5 mm wide; gray	www.wago.com/280-852/281-413
	Nr. articol: 280-852/281-414 Fuse plug; with soldered miniature fuse; with indicator lamp; LED (red); DC 30 - 65 V; 500 mA FF; 5 mm wide; gray	www.wago.com/280-852/281-414
	Nr. articol: 280-852/281-415 Fuse plug; with soldered miniature fuse; with indicator lamp; LED (red); AC 15 - 30 V; 500 mA FF; 5 mm wide; gray	www.wago.com/280-852/281-415
	Nr. articol: 280-854 Fuse plug; with soldered miniature fuse; 1 A FF; 5 mm wide; gray	www.wago.com/280-854
	Nr. articol: 280-854/281-413 Fuse plug; with soldered miniature fuse; with indicator lamp; LED (red); DC 15 - 30 V; 1 A FF; 5 mm wide; gray	www.wago.com/280-854/281-413
	Nr. articol: 280-854/281-414 Fuse plug; with soldered miniature fuse; with indicator lamp; LED (red); DC 30 - 65 V; 1 A FF; 5 mm wide; gray	www.wago.com/280-854/281-414
	Nr. articol: 280-854/281-415 Fuse plug; with soldered miniature fuse; with indicator lamp; LED (red); AC 15 - 30 V; 1 A FF; 5 mm wide; gray	www.wago.com/280-854/281-415
	Nr. articol: 280-856 Fuse plug; with soldered miniature fuse; 2 A FF; 5 mm wide; gray	www.wago.com/280-856
	Nr. articol: 280-856/281-413 Fuse plug; with soldered miniature fuse; with indicator lamp; LED (red); DC 15 - 30 V; 2 A FF; 5 mm wide; gray	www.wago.com/280-856/281-413
	Nr. articol: 280-856/281-414 Fuse plug; with soldered miniature fuse; with indicator lamp; LED (red); DC 30 - 65 V; 2 A FF; 5 mm wide; gray	www.wago.com/280-856/281-414
	Nr. articol: 280-856/281-415 Fuse plug; with soldered miniature fuse; with indicator lamp; LED (red); AC 15 - 30 V; 2 A FF; 5 mm wide; gray	www.wago.com/280-856/281-415
	Nr. articol: 281-511 Fuse plug; with pull-tab; for miniature metric fuses 5 x 20 mm and 5 x 25 mm; without blown fuse indication; 6 mm wide; gray	www.wago.com/281-511
	Nr. articol: 281-512 Fuse plug; with pull-tab; for miniature metric fuses 5 x 20 mm and 5 x 25 mm; with port for LED; 6 mm wide; gray	www.wago.com/281-512
	Nr. articol: 281-512/281-417 Fuse plug; with pull-tab; for miniature metric fuses 5 x 20 mm and 5 x 25 mm; with blown fuse indication by neon lamp; 230 V; 6 mm wide; gray	www.wago.com/281-512/281-417

Nr. articol: 281-512/281-418

Supus modificărilor.

WAGO Kontakttechnik GmbH & Co. KG
/Representative Office Romania
Sos. Pipera-Tunari nr. 1/1
building 1, 2nd floor | 077190 Voluntari, Ilfov
Tel.: +40-(0)31 421 85 68 | Email: info-RO@wago.com

Aveți întrebări despre produsele noastre?
Vă stăm la dispoziție pentru preluarea apelului la +40 (0) 31 421 85 68.



Fuse plug; with pull-tab; for miniature metric fuses 5 x 20 mm and 5 x 25 mm; with blown fuse indication by neon lamp; 120 V; 6 mm wide; gray

www.wago.com/281-512/281-418



Nr. articol: 281-512/281-501

Fuse plug; with pull-tab; for miniature metric fuses 5 x 20 mm and 5 x 25 mm; with LED indicator; 24 V AC/DC; 6 mm wide; gray

www.wago.com/281-512/281-501

ferrule



Nr. articol: 216-101

Ferrule; Sleeve for 0.5 mm² / AWG 22; uninsulated; electro-tin plated

www.wago.com/216-101



Nr. articol: 216-102

Ferrule; Sleeve for 0.75 mm² / AWG 20; uninsulated; electro-tin plated

www.wago.com/216-102



Nr. articol: 216-103

Ferrule; Sleeve for 1 mm² / AWG 18; uninsulated; electro-tin plated

www.wago.com/216-103



Nr. articol: 216-104

Ferrule; Sleeve for 1.5 mm² / AWG 16; uninsulated; electro-tin plated

www.wago.com/216-104



Nr. articol: 216-201

Ferrule; Sleeve for 0.5 mm² / 20 AWG; insulated; electro-tin plated; white

www.wago.com/216-201



Nr. articol: 216-202

Ferrule; Sleeve for 0.75 mm² / 18 AWG; insulated; electro-tin plated; gray

www.wago.com/216-202



Nr. articol: 216-203

Ferrule; Sleeve for 1 mm² / AWG 18; insulated; electro-tin plated; red

www.wago.com/216-203



Nr. articol: 216-204

Ferrule; Sleeve for 1.5 mm² / AWG 16; insulated; electro-tin plated; black

www.wago.com/216-204

Nr. articol: 216-301

Ferrule; Sleeve for 0.25 mm² / AWG 24; insulated; electro-tin plated; yellow

www.wago.com/216-301



Nr. articol: 216-302

Ferrule; Sleeve for 0.34 mm² / 22 AWG; insulated; electro-tin plated; green

www.wago.com/216-302

assembling



Nr. articol: 709-154

Cover; Type 2; suitable for cover carrier, type 2; 1 m long; transparent

www.wago.com/709-154

Descărcări

Documentation

Additional Information

Technical explanations

Apr 3, 2019

pdf
2,1 MB

Descărcare

Supus modificărilor.

WAGO Kontakttechnik GmbH & Co. KG
/Representative Office Romania
Sos. Pipera-Tunari nr. 1/1
building 1, 2nd floor | 077190 Voluntari, Ilfov
Tel.: +40-(0)31 421 85 68 | Email: info-RO@wago.com

Aveți întrebări despre produsele noastre?
Vă stăm la dispoziție pentru preluarea apelului la +40 (0) 31 421 85 68.

CAD/CAE-Data

CAD data

2D/3D Models 280-588/280-320	URL	Descărcare
------------------------------	-----	------------

CAE data

EPLAN Data Portal 280-588/280-320	URL	Descărcare
-----------------------------------	-----	------------

WSCAD Universe 280-588/280-320	URL	Descărcare
--------------------------------	-----	------------

Installation Notes

Installation

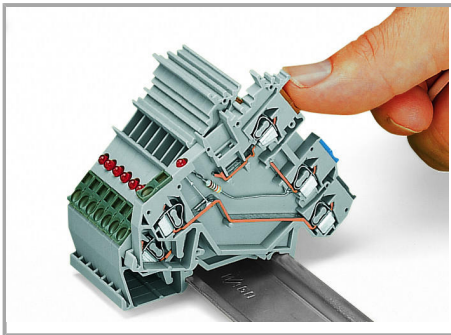

Snapping a terminal block onto the carrier rail – terminal blocks with a grounding foot automatically establish a direct contact to the rail.

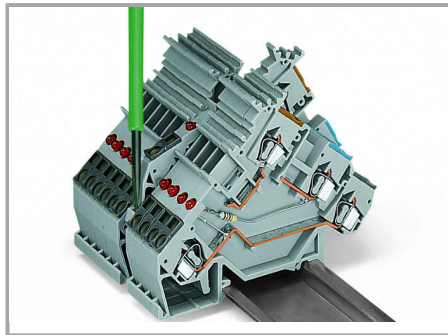

Removing a terminal block from the carrier rail. Notice: Remove jumper contacts first.

Conductor termination

Supus modificărilor.

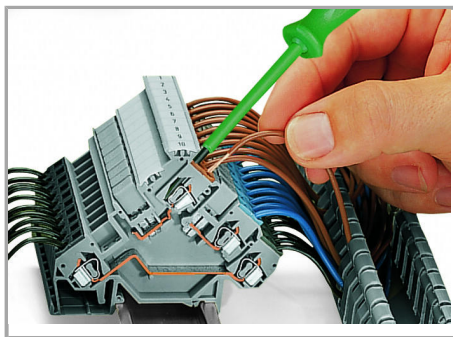

CAGE CLAMP® connection

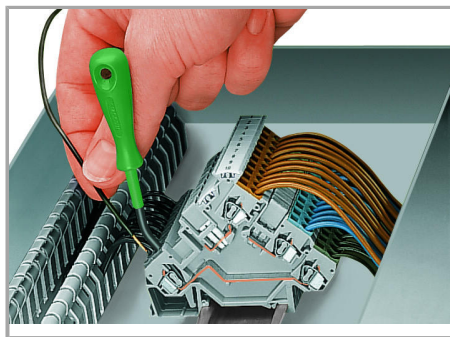

CAGE CLAMP® connection

Inserting a conductor via straight operating tool (210-720).

Inserting a conductor via angled operating tool (210-658).

Commoning

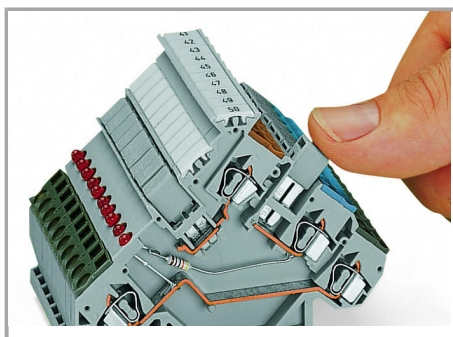

Commoning using an adjacent jumper (280-402).

Push jumper down until fully inserted.

Testing

Supus modificărilor.

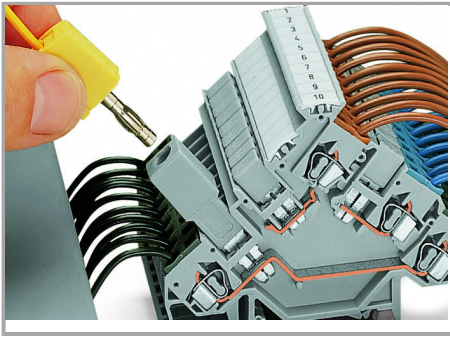

Testing via banana plug and test plug adapter (209-170).

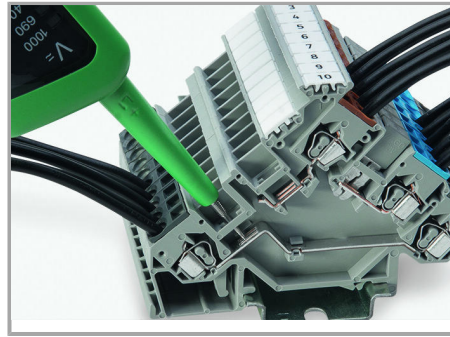

Testing via voltage tester directly on the current bar.

Installation

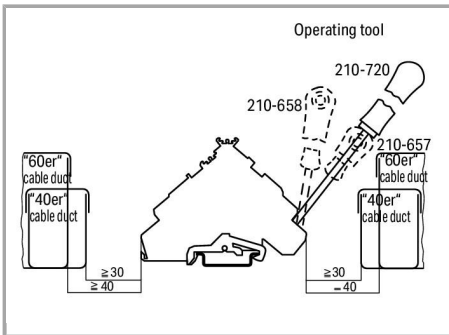

Min. mounting distance – terminal blocks to cable duct

Marking

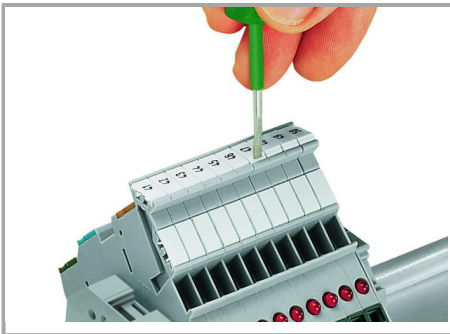

Labeling via WMB Multi Marking System.

Supus modificărilor.