

Fișă tehnică | Număr articol: 280-998

3-conductor through terminal block; 2.5 mm²; suitable for Ex e II applications; center marking; for DIN-rail 35 x 15 and 35 x 7.5; CAGE CLAMP®; 2,50 mm²; light gray

www.wago.com/280-998

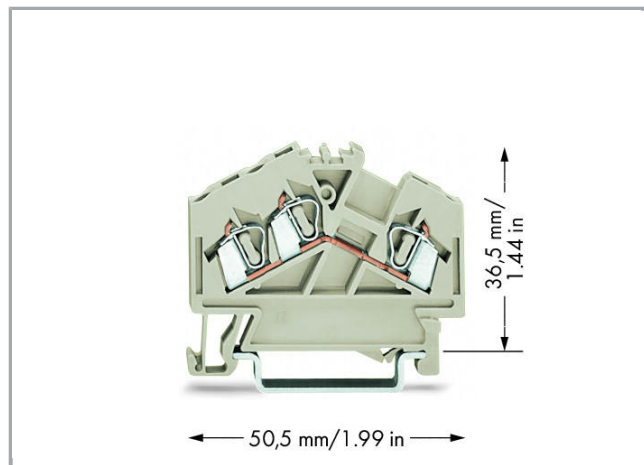
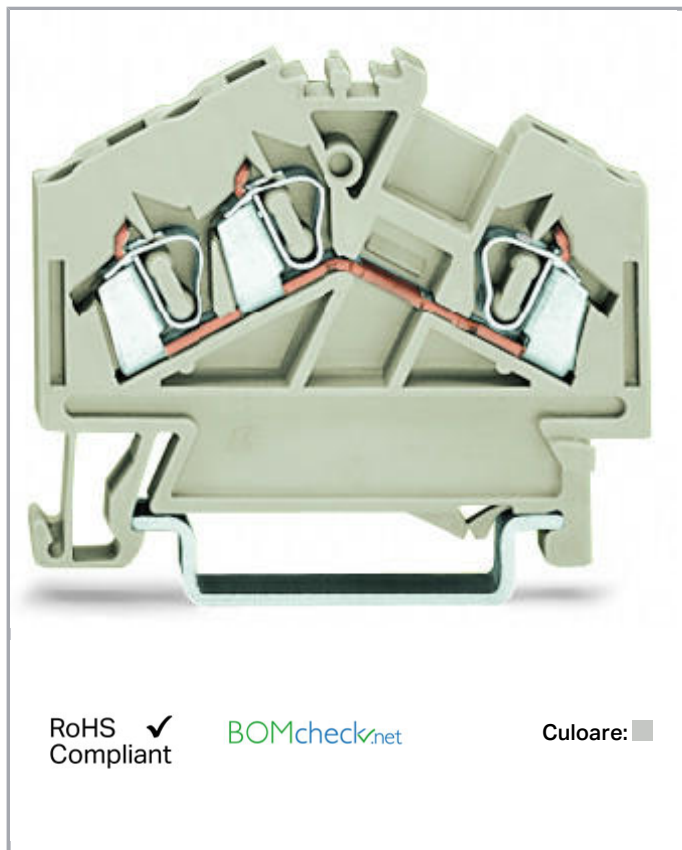

Supus modificărilor.

WAGO Kontakttechnik GmbH & Co. KG
/Representative Office Romania
Sos. Pipera-Tunari nr. 1/1
building 1, 2nd floor | 077190 Voluntari, Ilfov
Tel.: +40-(0)31 421 85 68 | Email: info-RO@wago.com

Aveți întrebări despre produsele noastre?
Vă stăm la dispoziție pentru preluarea apelului la +40 (0) 31 421 85 68.

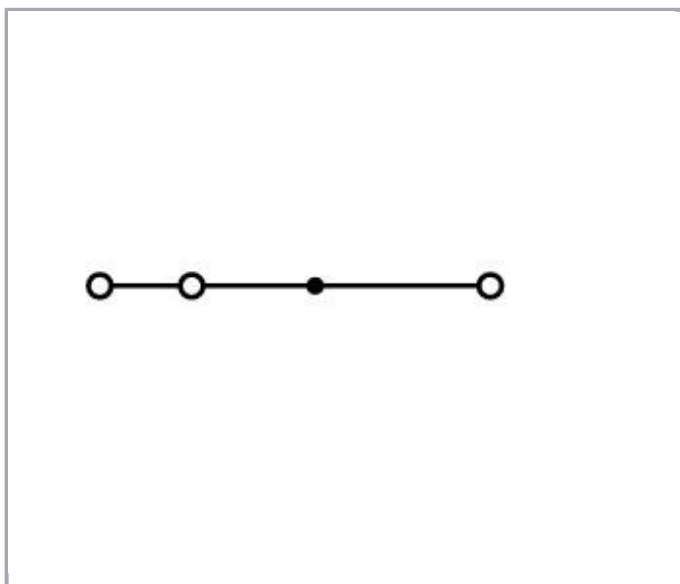

Descriere articol

Note:

Terminating Aluminum Conductors

WAGO spring clamp terminal blocks are suitable for solid aluminum conductors up to 4 mm²/12 AWG if WAGO "Alu-Plus" Contact Paste is used for termination.

"Alu-Plus" Contact Paste Advantages:

- Automatically destroys the oxide film during clamping.
- Prevents fresh oxidation at the clamping point.
- Prevents electrolytic corrosion between aluminum and copper conductors (in the same terminal block).
- Provides long-term protection against corrosion.

Using terminal blocks with CAGE CLAMP® Spring Pressure Connection Technology, **aluminum conductors must first be cleaned with a blade** and then immediately be inserted into the clamping units filled with "Alu-Plus" Contact Paste.

It is also possible to apply WAGO "Alu-Plus" **additionally** on the whole surface of the aluminum conductor before termination.

Please note that the nominal currents must be adapted to the reduced conductivity of the aluminum conductors::

2.5 mm² = 16 A

4 mm² = 22 A

Date

Electrical data

Supus modificărilor.

Ratings per IEC/EN 60664-1

| | |
|-------------|------------------|
| Ratings per | IEC/EN 60947-7-1 |
|-------------|------------------|

Approvals Ex

| | |
|----------------------------|-------|
| Rated voltage EN (Ex e II) | 550 V |
| Rated current (Ex e II) | 23 A |

Connection data

| | |
|-----------------------------------|--|
| Connection technology | CAGE CLAMP® |
| Actuation type | Operating tool |
| Connectable conductor materials | Copper Aluminum |
| Solid conductor | 0,08 ... 2,5 mm ² / 28 ... 12 AWG |
| Fine-stranded conductor | 0,08 ... 2,5 mm ² / 28 ... 12 AWG |
| Strip length | 8 ... 9 mm / 0.31 ... 0.35 inch |
| Total number of connection points | 3 |
| Total number of potentials | 1 |
| Number of levels | 1 |
| Wiring type | Front-entry wiring |
| Note (conductor cross-section) | 12 AWG: THHN, THWN |

Geometrical Data

| | |
|------------------------------------|----------------------|
| Width | 5 mm / 0.197 inch |
| Height from upper-edge of DIN-rail | 36,5 mm / 1.437 inch |
| Depth | 50,5 mm / 1.988 inch |

Mechanical data

| | |
|---------------|----------------|
| Design | angled |
| Mounting type | DIN-35 rail |
| Marking level | Center marking |

Material Data

| | |
|---------------------|----------------------|
| Color | light gray |
| Insulation material | Polyamide 66 (PA 66) |
| Fire load | 0,12 MJ |
| Weight | 6,8 g |



Supus modificărilor.

Commercial data



| | |
|-----------------------|----------------------------------|
| Product Group | 1 (Rail Mounted Terminal Blocks) |
| Packaging type | BOX |
| Country of origin | DE |
| GTIN | 4044918328043 |
| Customs tariff number | 85369010000 |

Aprobări / certificate

Ex-Approvals

| Emblemă | Aprobare | Text de aprobare suplimentar | Nume certificat |
|--|---|------------------------------|--------------------------|
|  | AEx UL International Germany GmbH c/o Physikalisch Technische Bundesanstalt | UL 60079 | E185892 sec.1 |
|  | ATEx Physikalisch Technische Bundesanstalt (PTB) | EN 60079 | PTB 99 ATEX 3109 U |

Country specific Approvals

| Emblemă | Aprobare | Text de aprobare suplimentar | Nume certificat |
|--|--|------------------------------|-----------------|
|  | CCA DEKRA Certification B.V. | EN 60947 | 2157201.01 |
|  | CSA DEKRA Certification B.V. | C22.2 | 1536071 |

Ship Approvals

| Emblemă | Aprobare | Text de aprobare suplimentar | Nume certificat |
|--|---|------------------------------|--------------------------|
|  | ABS American Bureau of Shipping | EN 60947 | 20- HG1941090- PDA |
| | BV Bureau Veritas S.A. | EN 60947 | 07436/E0 BV |

Supus modificărilor.

WAGO Kontakttechnik GmbH & Co. KG
/Representative Office Romania
Sos. Pipera-Tunari nr. 1/1
building 1, 2nd floor | 077190 Voluntari, Ilfov
Tel.: +40-(0)31 421 85 68 | Email: info-RO@wago.com

Aveți întrebări despre produsele noastre?
Vă stăm la dispoziție pentru preluarea apelului la +40 (0) 31 421 85 68.

BUREAU
VERITAS

DNV GL

Det Norske Veritas, Germanischer Lloyd

-

TAE00001V2



LR

Lloyds Register

EN 60947

91/20112
(E9)

UL-Approvals

| Emblemă | Aprobare | Text de aprobare suplimentar | Nume certificat |
|--|-------------------------------------|------------------------------|---------------------|
|  | UL UL International Germany GmbH | UL 1059 | 20190731- E45172 |

Counterpart

Produse compatibile

Protective Warning Marker



Nr. articol: 280-415

Protective warning marker; with high-voltage symbol, black; for 5 terminal blocks; yellow

www.wago.com/280-415

Jumper



Nr. articol: 249-123



















Push-in type wire jumper; insulated; wire length 180 mm; Conductor cross section 0.75 mm²www.wago.com/249-123

Nr. articol: 249-125

Supus modificărilor.

WAGO Kontakttechnik GmbH & Co. KG
/Representative Office Romania
Sos. Pipera-Tunari nr. 1/1
building 1, 2nd floor | 077190 Voluntari, Ilfov
Tel.: +40-(0)31 421 85 68 | Email: info-RO@wago.com

Aveți întrebări despre produsele noastre?
Vă stăm la dispoziție pentru preluarea apelului la +40 (0) 31 421 85 68.

| | | |
|--|--|--|
|  | Push-in type wire jumper; insulated; wire length 60 mm; Conductor cross section 0.75 mm ² | www.wago.com/249-125 |
|  | Nr. articol: 249-126 Push-in type wire jumper; insulated; wire length 110 mm; Conductor cross section 0.75 mm ² | www.wago.com/249-126 |
|  | Nr. articol: 249-127 Push-in type wire jumper; insulated; wire length 250 mm; Conductor cross section 0.75 mm ² | www.wago.com/249-127 |
|  | Nr. articol: 280-402 Adjacent jumper; insulated; IN = IN terminal block; gray | www.wago.com/280-402 |
|  | Nr. articol: 280-409 Alternate jumper; insulated; IN = IN terminal block; gray | www.wago.com/280-409 |
|  | Nr. articol: 280-422 Adjacent jumper; insulated; IN = IN terminal block; yellow-green | www.wago.com/280-422 |
|  | Nr. articol: 280-482 Comb-style jumper bar; insulated; 2-way; IN = IN terminal block; gray | www.wago.com/280-482 |
|  | Nr. articol: 280-483 Comb-style jumper bar; insulated; 3-way; IN = IN terminal block; gray | www.wago.com/280-483 |
|  | Nr. articol: 280-484 Comb-style jumper bar; insulated; 4-way; IN = IN terminal block; gray | www.wago.com/280-484 |
|  | Nr. articol: 280-485 Comb-style jumper bar; insulated; 5-way; IN = IN terminal block; gray | www.wago.com/280-485 |
|  | Nr. articol: 280-490 Comb-style jumper bar; insulated; 10-way; IN = IN terminal block; gray | www.wago.com/280-490 |
|  | Nr. articol: 280-492 Alternate comb-style jumper bar; insulated; 2-way; IN = IN terminal block; gray | www.wago.com/280-492 |
|  | Nr. articol: 780-452 Staggered jumper; insulated; from 1 to 2; Spacing: 5 mm; suitable for 2-conductor female plugs; gray | www.wago.com/780-452 |
|  | Nr. articol: 780-453 Staggered jumper; insulated; from 1 to 3; Spacing: 5 mm; suitable for 2-conductor female plugs; gray | www.wago.com/780-453 |
|  | Nr. articol: 780-454 Staggered jumper; insulated; from 1 to 4; Spacing: 5 mm; suitable for 2-conductor female plugs; gray | www.wago.com/780-454 |
|  | Nr. articol: 780-455 Staggered jumper; insulated; from 1 to 5; Spacing: 5 mm; suitable for 2-conductor female plugs; gray | www.wago.com/780-455 |
|  | Nr. articol: 780-456 Staggered jumper; insulated; from 1 to 6; Spacing: 5 mm; suitable for 2-conductor female plugs; gray | www.wago.com/780-456 |
|  | Nr. articol: 780-457 Staggered jumper; insulated; from 1 to 7; Spacing: 5 mm; suitable for 2-conductor female plugs; gray | www.wago.com/780-457 |

Supus modificărilor.

**Nr. articol: 780-458**

Staggered jumper; insulated; from 1 to 8; Spacing: 5 mm; suitable for 2-conductor female plugs; gray

www.wago.com/780-458**Female plug****Nr. articol: 232-132/005-000**

Female connector for rail-mount terminal blocks; 0.6 x 1 mm pins; straight; Pin spacing 5 mm; 2-pole; gray

www.wago.com/232-132/005-000**Nr. articol: 232-132/005-000/039-000**

Female connector for rail-mount terminal blocks; 0.6 x 1 mm pins; straight; Locking lever; Pin spacing 5 mm; 2-pole; gray

www.wago.com/232-132/005-000/039-000**Nr. articol: 232-133/005-000**

Female connector for rail-mount terminal blocks; 0.6 x 1 mm pins; straight; Pin spacing 5 mm; 3-pole; gray

www.wago.com/232-133/005-000**Nr. articol: 232-133/005-000/039-000**

Female connector for rail-mount terminal blocks; 0.6 x 1 mm pins; straight; Locking lever; Pin spacing 5 mm; 3-pole; gray

www.wago.com/232-133/005-000/039-000**Nr. articol: 232-134/005-000**

Female connector for rail-mount terminal blocks; 0.6 x 1 mm pins; straight; Pin spacing 5 mm; 4-pole; gray

www.wago.com/232-134/005-000**Nr. articol: 232-134/005-000/039-000**

Female connector for rail-mount terminal blocks; 0.6 x 1 mm pins; straight; Locking lever; Pin spacing 5 mm; 4-pole; gray

www.wago.com/232-134/005-000/039-000**Nr. articol: 232-135/005-000**

Female connector for rail-mount terminal blocks; 0.6 x 1 mm pins; straight; Pin spacing 5 mm; 5-pole; gray

www.wago.com/232-135/005-000**Nr. articol: 232-135/005-000/039-000**

Female connector for rail-mount terminal blocks; 0.6 x 1 mm pins; straight; Locking lever; Pin spacing 5 mm; 5-pole; gray

www.wago.com/232-135/005-000/039-000**Nr. articol: 232-136/005-000**

Female connector for rail-mount terminal blocks; 0.6 x 1 mm pins; straight; Pin spacing 5 mm; 6-pole; gray

www.wago.com/232-136/005-000**Nr. articol: 232-136/005-000/039-000**

Female connector for rail-mount terminal blocks; 0.6 x 1 mm pins; straight; Locking lever; Pin spacing 5 mm; 6-pole; gray

www.wago.com/232-136/005-000/039-000**Nr. articol: 232-137/005-000**













Female connector for rail-mount terminal blocks; 0.6 x 1 mm pins; straight; Pin spacing 5 mm; 7-pole; gray

www.wago.com/232-137/005-000**Nr. articol: 232-137/005-000/039-000**

Female connector for rail-mount terminal blocks; 0.6 x 1 mm pins; straight; Locking lever; Pin spacing 5 mm; 7-pole; gray

www.wago.com/232-137/005-000/039-000**Nr. articol: 232-138/005-000**













Supus modificărilor.

| | | |
|--|---|--|
|  | Female connector for rail-mount terminal blocks; 0.6 x 1 mm pins; straight; Pin spacing 5 mm; 8-pole; gray | www.wago.com/232-138/005-000 |
|  | Nr. articol: 232-138/005-000/039-000 Female connector for rail-mount terminal blocks; 0.6 x 1 mm pins; straight; Locking lever; Pin spacing 5 mm; 8-pole; gray | www.wago.com/232-138/005-000/039-000 |
|  | Nr. articol: 232-139/005-000 Female connector for rail-mount terminal blocks; 0.6 x 1 mm pins; straight; Pin spacing 5 mm; 9-pole; gray | www.wago.com/232-139/005-000 |
|  | Nr. articol: 232-139/005-000/039-000 Female connector for rail-mount terminal blocks; 0.6 x 1 mm pins; straight; Locking lever; Pin spacing 5 mm; 9-pole; gray | www.wago.com/232-139/005-000/039-000 |
|  | Nr. articol: 232-140/005-000 Female connector for rail-mount terminal blocks; 0.6 x 1 mm pins; straight; Pin spacing 5 mm; 10-pole; gray | www.wago.com/232-140/005-000 |
|  | Nr. articol: 232-140/005-000/039-000 Female connector for rail-mount terminal blocks; 0.6 x 1 mm pins; straight; Locking lever; Pin spacing 5 mm; 10-pole; gray | www.wago.com/232-140/005-000/039-000 |
|  | Nr. articol: 232-142/005-000 Female connector for rail-mount terminal blocks; 0.6 x 1 mm pins; straight; Pin spacing 5 mm; 12-pole; gray | www.wago.com/232-142/005-000 |
|  | Nr. articol: 232-142/005-000/039-000 Female connector for rail-mount terminal blocks; 0.6 x 1 mm pins; straight; Locking lever; Pin spacing 5 mm; 12-pole; gray | www.wago.com/232-142/005-000/039-000 |
|  | Nr. articol: 232-146/005-000 Female connector for rail-mount terminal blocks; 0.6 x 1 mm pins; straight; Pin spacing 5 mm; 16-pole; gray | www.wago.com/232-146/005-000 |
|  | Nr. articol: 232-146/005-000/039-000 Female connector for rail-mount terminal blocks; 0.6 x 1 mm pins; straight; Locking lever; Pin spacing 5 mm; 16-pole; gray | www.wago.com/232-146/005-000/039-000 |
|  | Nr. articol: 232-147/005-000/039-000 Female connector for rail-mount terminal blocks; 0.6 x 1 mm pins; straight; Locking lever; Pin spacing 5 mm; 17-pole; gray | www.wago.com/232-147/005-000/039-000 |
|  | Nr. articol: 232-150/005-000 Female connector for rail-mount terminal blocks; 0.6 x 1 mm pins; straight; Pin spacing 5 mm; 20-pole; gray | www.wago.com/232-150/005-000 |
|  | Nr. articol: 232-150/005-000/039-000 Female connector for rail-mount terminal blocks; 0.6 x 1 mm pins; straight; Locking lever; Pin spacing 5 mm; 20-pole; gray | www.wago.com/232-150/005-000/039-000 |
| | Nr. articol: 232-232/005-000 | |

Supus modificărilor.













WAGO Kontakttechnik GmbH & Co. KG
 /Representative Office Romania
 Sos. Pipera-Tunari nr. 1/1
 building 1, 2nd floor | 077190 Voluntari, Ilfov
 Tel.: +40-(0)31 421 85 68 | Email: info-RO@wago.com

Aveți întrebări despre produsele noastre?
 Vă stăm la dispoziție pentru preluarea apelului la +40 (0) 31 421 85 68.

| | | |
|--|--|--|
|  | Female connector for rail-mount terminal blocks; 0.6 x 1 mm pins; angled; Pin spacing 5 mm; 2-pole; gray | www.wago.com/232-232/005-000 |
|  | Nr. articol: 232-232/005-000/039-000 Female connector for rail-mount terminal blocks; 0.6 x 1 mm pins; angled; Locking lever; Pin spacing 5 mm; 2-pole; gray | www.wago.com/232-232/005-000/039-000 |
|  | Nr. articol: 232-233/005-000 Female connector for rail-mount terminal blocks; 0.6 x 1 mm pins; angled; Pin spacing 5 mm; 3-pole; gray | www.wago.com/232-233/005-000 |
|  | Nr. articol: 232-233/005-000/039-000 Female connector for rail-mount terminal blocks; 0.6 x 1 mm pins; angled; Locking lever; Pin spacing 5 mm; 3-pole; gray | www.wago.com/232-233/005-000/039-000 |
|  | Nr. articol: 232-234/005-000 Female connector for rail-mount terminal blocks; 0.6 x 1 mm pins; angled; Pin spacing 5 mm; 4-pole; gray | www.wago.com/232-234/005-000 |
|  | Nr. articol: 232-234/005-000/039-000 Female connector for rail-mount terminal blocks; 0.6 x 1 mm pins; angled; Locking lever; Pin spacing 5 mm; 4-pole; gray | www.wago.com/232-234/005-000/039-000 |
|  | Nr. articol: 232-235/005-000 Female connector for rail-mount terminal blocks; 0.6 x 1 mm pins; angled; Pin spacing 5 mm; 5-pole; gray | www.wago.com/232-235/005-000 |
|  | Nr. articol: 232-235/005-000/039-000 Female connector for rail-mount terminal blocks; 0.6 x 1 mm pins; angled; Locking lever; Pin spacing 5 mm; 5-pole; gray | www.wago.com/232-235/005-000/039-000 |
|  | Nr. articol: 232-236/005-000 Female connector for rail-mount terminal blocks; 0.6 x 1 mm pins; angled; Pin spacing 5 mm; 6-pole; gray | www.wago.com/232-236/005-000 |
|  | Nr. articol: 232-236/005-000/039-000 Female connector for rail-mount terminal blocks; 0.6 x 1 mm pins; angled; Locking lever; Pin spacing 5 mm; 6-pole; gray | www.wago.com/232-236/005-000/039-000 |
|  | Nr. articol: 232-237/005-000 Female connector for rail-mount terminal blocks; 0.6 x 1 mm pins; angled; Pin spacing 5 mm; 7-pole; gray | www.wago.com/232-237/005-000 |
|  | Nr. articol: 232-238/005-000 Female connector for rail-mount terminal blocks; 0.6 x 1 mm pins; angled; Pin spacing 5 mm; 8-pole; gray | www.wago.com/232-238/005-000 |
|  | Nr. articol: 232-239/005-000 Female connector for rail-mount terminal blocks; 0.6 x 1 mm pins; angled; Pin spacing 5 mm; 9-pole; gray | www.wago.com/232-239/005-000 |

Nr. articol: 232-240/005-000

Supus modificărilor.

| | | |
|--|---|--|
|  | Female connector for rail-mount terminal blocks; 0.6 x 1 mm pins; angled; Pin spacing 5 mm; 10-pole; gray | www.wago.com/232-240/005-000 |
|  | Nr. articol: 232-240/005-000/039-000 Female connector for rail-mount terminal blocks; 0.6 x 1 mm pins; angled; Locking lever; Pin spacing 5 mm; 10-pole; gray | www.wago.com/232-240/005-000/039-000 |
|  | Nr. articol: 232-242/005-000 Female connector for rail-mount terminal blocks; 0.6 x 1 mm pins; angled; Pin spacing 5 mm; 12-pole; gray | www.wago.com/232-242/005-000 |
|  | Nr. articol: 232-242/005-000/039-000 Female connector for rail-mount terminal blocks; 0.6 x 1 mm pins; angled; Locking lever; Pin spacing 5 mm; 12-pole; gray | www.wago.com/232-242/005-000/039-000 |
|  | Nr. articol: 232-246/005-000 Female connector for rail-mount terminal blocks; 0.6 x 1 mm pins; angled; Pin spacing 5 mm; 16-pole; gray | www.wago.com/232-246/005-000 |
|  | Nr. articol: 232-246/005-000/039-000 Female connector for rail-mount terminal blocks; 0.6 x 1 mm pins; angled; Locking lever; Pin spacing 5 mm; 16-pole; gray | www.wago.com/232-246/005-000/039-000 |
|  | Nr. articol: 232-250/005-000 Female connector for rail-mount terminal blocks; 0.6 x 1 mm pins; angled; Pin spacing 5 mm; 20-pole; gray | www.wago.com/232-250/005-000 |
|  | Nr. articol: 232-250/005-000/039-000 Female connector for rail-mount terminal blocks; 0.6 x 1 mm pins; angled; Locking lever; Pin spacing 5 mm; 20-pole; gray | www.wago.com/232-250/005-000/039-000 |
|  | Nr. articol: 232-732/005-000 THT female header; 0.6 x 1.0 mm solder pin; gray | www.wago.com/232-732/005-000 |
|  | Nr. articol: 232-733/005-000 THT female header; 0.6 x 1.0 mm solder pin; gray | www.wago.com/232-733/005-000 |
|  | Nr. articol: 232-734/005-000 THT female header; 0.6 x 1.0 mm solder pin; gray | www.wago.com/232-734/005-000 |
|  | Nr. articol: 232-734/005-000/039-000 THT female header; 0.6 x 1.0 mm solder pin; gray | www.wago.com/232-734/005-000/039-000 |
|  | Nr. articol: 232-735/005-000 THT female header; 0.6 x 1.0 mm solder pin; gray | www.wago.com/232-735/005-000 |

Supus modificărilor.



Nr. articol: 232-735/005-000/039-000
THT female header; 0.6 x 1.0 mm solder pin; gray

www.wago.com/232-735/005-000/039-000



Nr. articol: 232-736/005-000
THT female header; 0.6 x 1.0 mm solder pin; gray

www.wago.com/232-736/005-000



Nr. articol: 232-736/005-000/039-000
THT female header; 0.6 x 1.0 mm solder pin; gray

www.wago.com/232-736/005-000/039-000



Nr. articol: 232-738/005-000
THT female header; 0.6 x 1.0 mm solder pin; gray

www.wago.com/232-738/005-000



Nr. articol: 232-740/005-000
THT female header; 0.6 x 1.0 mm solder pin; gray

www.wago.com/232-740/005-000



Nr. articol: 232-742/005-000
THT female header; 0.6 x 1.0 mm solder pin; gray

www.wago.com/232-742/005-000



Nr. articol: 232-832/005-000
THT female header; 0.6 x 1.0 mm solder pin; angled; Pin spacing 7.5 mm; 2-pole; gray

www.wago.com/232-832/005-000



Nr. articol: 232-833/005-000
THT female header; 0.6 x 1.0 mm solder pin; angled; Pin spacing 7.5 mm; 3-pole; gray

www.wago.com/232-833/005-000



Nr. articol: 232-834/005-000
THT female header; 0.6 x 1.0 mm solder pin; angled; Pin spacing 7.5 mm; 4-pole; gray

www.wago.com/232-834/005-000



Nr. articol: 232-836/005-000
THT female header; 0.6 x 1.0 mm solder pin; angled; Pin spacing 7.5 mm; 6-pole; gray

www.wago.com/232-836/005-000



Nr. articol: 232-836/005-000/039-000
THT female header; 0.6 x 1.0 mm solder pin; angled; Locking lever; Pin spacing 7.5 mm; 6-pole; gray

www.wago.com/232-836/005-000/039-000



Nr. articol: 232-840/005-000
THT female header; 0.6 x 1.0 mm solder pin; angled; Pin spacing 7.5 mm; 10-pole; gray

www.wago.com/232-840/005-000















Nr. articol: 232-842/005-000
THT female header; 0.6 x 1.0 mm solder pin; angled; Pin spacing 7.5 mm; 12-pole; gray













www.wago.com/232-842/005-000

Nr. articol: 722-132/005-000

Supus modificărilor.

| | | |
|--|--|--|
|  | Female connector for rail-mount terminal blocks; 0.6 x 1 mm pins; straight; 100% protected against mismatching; Pin spacing 5 mm; 2-pole; light gray | www.wago.com/722-132/005-000 |
|  | Nr. articol: 722-132/005-000/039-000 Female connector for rail-mount terminal blocks; 0.6 x 1 mm pins; straight; 100% protected against mismatching; Locking lever; Pin spacing 5 mm; 2-pole; light gray | www.wago.com/722-132/005-000/039-000 |
|  | Nr. articol: 722-133/005-000 Female connector for rail-mount terminal blocks; 0.6 x 1 mm pins; straight; 100% protected against mismatching; Pin spacing 5 mm; 3-pole; light gray | www.wago.com/722-133/005-000 |
|  | Nr. articol: 722-133/005-000/039-000 Female connector for rail-mount terminal blocks; 0.6 x 1 mm pins; straight; 100% protected against mismatching; Locking lever; Pin spacing 5 mm; 3-pole; light gray | www.wago.com/722-133/005-000/039-000 |
|  | Nr. articol: 722-134/005-000 Female connector for rail-mount terminal blocks; 0.6 x 1 mm pins; straight; 100% protected against mismatching; Pin spacing 5 mm; 4-pole; light gray | www.wago.com/722-134/005-000 |
|  | Nr. articol: 722-134/005-000/039-000 Female connector for rail-mount terminal blocks; 0.6 x 1 mm pins; straight; 100% protected against mismatching; Locking lever; Pin spacing 5 mm; 4-pole; light gray | www.wago.com/722-134/005-000/039-000 |
|  | Nr. articol: 722-135/005-000 Female connector for rail-mount terminal blocks; 0.6 x 1 mm pins; straight; 100% protected against mismatching; Pin spacing 5 mm; 5-pole; light gray | www.wago.com/722-135/005-000 |
|  | Nr. articol: 722-135/005-000/039-000 Female connector for rail-mount terminal blocks; 0.6 x 1 mm pins; straight; 100% protected against mismatching; Locking lever; Pin spacing 5 mm; 5-pole; light gray | www.wago.com/722-135/005-000/039-000 |
|  | Nr. articol: 722-136/005-000 Female connector for rail-mount terminal blocks; 0.6 x 1 mm pins; straight; 100% protected against mismatching; Pin spacing 5 mm; 6-pole; light gray | www.wago.com/722-136/005-000 |
|  | Nr. articol: 722-136/005-000/039-000 Female connector for rail-mount terminal blocks; 0.6 x 1 mm pins; straight; 100% protected against mismatching; Locking lever; Pin spacing 5 mm; 6-pole; light gray | www.wago.com/722-136/005-000/039-000 |
|  | Nr. articol: 722-137/005-000 Female connector for rail-mount terminal blocks; 0.6 x 1 mm pins; straight; 100% protected against mismatching; Pin spacing 5 mm; 7-pole; light gray | www.wago.com/722-137/005-000 |
|  | Nr. articol: 722-137/005-000/039-000 Female connector for rail-mount terminal blocks; 0.6 x 1 mm pins; straight; 100% protected against mismatching; Locking lever; Pin spacing 5 mm; 7-pole; light gray | www.wago.com/722-137/005-000/039-000 |
|  | Nr. articol: 722-138/005-000 Female connector for rail-mount terminal blocks; 0.6 x 1 mm pins; straight; 100% protected against mismatching; Pin spacing 5 mm; 8-pole; light gray | www.wago.com/722-138/005-000 |
| | Nr. articol: 722-138/005-000/039-000 | |

Supus modificărilor.

| | | |
|--|---|--|
|  | Female connector for rail-mount terminal blocks; 0.6 x 1 mm pins; straight; 100% protected against mismatching; Locking lever; Pin spacing 5 mm; 8-pole; light gray | www.wago.com/722-138/005-000/039-000 |
|  | Nr. articol: 722-139/005-000 Female connector for rail-mount terminal blocks; 0.6 x 1 mm pins; straight; 100% protected against mismatching; Pin spacing 5 mm; 9-pole; light gray | www.wago.com/722-139/005-000 |
|  | Nr. articol: 722-139/005-000/039-000 Female connector for rail-mount terminal blocks; 0.6 x 1 mm pins; straight; 100% protected against mismatching; Locking lever; Pin spacing 5 mm; 9-pole; light gray | www.wago.com/722-139/005-000/039-000 |
|  | Nr. articol: 722-140/005-000 Female connector for rail-mount terminal blocks; 0.6 x 1 mm pins; straight; 100% protected against mismatching; Pin spacing 5 mm; 10-pole; light gray | www.wago.com/722-140/005-000 |
|  | Nr. articol: 722-140/005-000/039-000 Female connector for rail-mount terminal blocks; 0.6 x 1 mm pins; straight; 100% protected against mismatching; Locking lever; Pin spacing 5 mm; 10-pole; light gray | www.wago.com/722-140/005-000/039-000 |
|  | Nr. articol: 722-141/005-000 Female connector for rail-mount terminal blocks; 0.6 x 1 mm pins; straight; 100% protected against mismatching; Pin spacing 5 mm; 11-pole; light gray | www.wago.com/722-141/005-000 |
|  | Nr. articol: 722-142/005-000 Female connector for rail-mount terminal blocks; 0.6 x 1 mm pins; straight; 100% protected against mismatching; Pin spacing 5 mm; 12-pole; light gray | www.wago.com/722-142/005-000 |
|  | Nr. articol: 722-142/005-007/039-000 Female connector for rail-mount terminal blocks; gray | www.wago.com/722-142/005-007/039-000 |
|  | Nr. articol: 722-143/005-000 Female connector for rail-mount terminal blocks; 0.6 x 1 mm pins; straight; 100% protected against mismatching; Pin spacing 5 mm; 13-pole; light gray | www.wago.com/722-143/005-000 |
|  | Nr. articol: 722-144/005-000 Female connector for rail-mount terminal blocks; 0.6 x 1 mm pins; straight; 100% protected against mismatching; Pin spacing 5 mm; 14-pole; light gray | www.wago.com/722-144/005-000 |
|  | Nr. articol: 722-144/005-000/039-000 Female connector for rail-mount terminal blocks; 0.6 x 1 mm pins; straight; 100% protected against mismatching; Locking lever; Pin spacing 5 mm; 14-pole; light gray | www.wago.com/722-144/005-000/039-000 |
|  | Nr. articol: 722-145/005-000 Female connector for rail-mount terminal blocks; 0.6 x 1 mm pins; straight; 100% protected against mismatching; Pin spacing 5 mm; 15-pole; light gray | www.wago.com/722-145/005-000 |
|  | Nr. articol: 722-146/005-000 Female connector for rail-mount terminal blocks; 0.6 x 1 mm pins; straight; 100% protected against mismatching; Pin spacing 5 mm; 16-pole; light gray | www.wago.com/722-146/005-000 |

Nr. articol: 722-146/005-000/039-000

Supus modificărilor.

WAGO Kontakttechnik GmbH & Co. KG
/Representative Office Romania
Sos. Pipera-Tunari nr. 1/1
building 1, 2nd floor | 077190 Voluntari, Ilfov
Tel.: +40-(0)31 421 85 68 | Email: info-RO@wago.com

Aveți întrebări despre produsele noastre?
Vă stăm la dispoziție pentru preluarea apelului la +40 (0) 31 421 85 68.



Female connector for rail-mount terminal blocks; 0.6 x 1 mm pins; straight; 100% protected against mismatching; Locking lever; Pin spacing 5 mm; 16-pole; light gray

www.wago.com/722-146/005-000/039-000



Nr. articol: 722-150/005-000

Female connector for rail-mount terminal blocks; 0.6 x 1 mm pins; straight; 100% protected against mismatching; Pin spacing 5 mm; 20-pole; light gray

www.wago.com/722-150/005-000



Nr. articol: 722-150/005-000/039-000

Female connector for rail-mount terminal blocks; 0.6 x 1 mm pins; straight; 100% protected against mismatching; Locking lever; Pin spacing 5 mm; 20-pole; light gray

www.wago.com/722-150/005-000/039-000



Nr. articol: 722-232/005-000

Female connector for rail-mount terminal blocks; 0.6 x 1 mm pins; angled; 100% protected against mismatching; Pin spacing 5 mm; 2-pole; light gray

www.wago.com/722-232/005-000



Nr. articol: 722-232/005-000/039-000

Female connector for rail-mount terminal blocks; 0.6 x 1 mm pins; angled; 100% protected against mismatching; Locking lever; Pin spacing 5 mm; 2-pole; light gray

www.wago.com/722-232/005-000/039-000



Nr. articol: 722-233/005-000

Female connector for rail-mount terminal blocks; 0.6 x 1 mm pins; angled; 100% protected against mismatching; Pin spacing 5 mm; 3-pole; light gray

www.wago.com/722-233/005-000



Nr. articol: 722-233/005-000/039-000

Female connector for rail-mount terminal blocks; 0.6 x 1 mm pins; angled; 100% protected against mismatching; Locking lever; Pin spacing 5 mm; 3-pole; light gray

www.wago.com/722-233/005-000/039-000



Nr. articol: 722-234/005-000

Female connector for rail-mount terminal blocks; 0.6 x 1 mm pins; angled; 100% protected against mismatching; Pin spacing 5 mm; 4-pole; light gray

www.wago.com/722-234/005-000



Nr. articol: 722-234/005-000/039-000

Female connector for rail-mount terminal blocks; 0.6 x 1 mm pins; angled; 100% protected against mismatching; Locking lever; Pin spacing 5 mm; 4-pole; light gray

www.wago.com/722-234/005-000/039-000



Nr. articol: 722-235/005-000

Female connector for rail-mount terminal blocks; 0.6 x 1 mm pins; angled; 100% protected against mismatching; Pin spacing 5 mm; 5-pole; light gray

www.wago.com/722-235/005-000



Nr. articol: 722-235/005-000/039-000

Female connector for rail-mount terminal blocks; 0.6 x 1 mm pins; angled; 100% protected against mismatching; Locking lever; Pin spacing 5 mm; 5-pole; light gray

www.wago.com/722-235/005-000/039-000



Nr. articol: 722-236/005-000

Female connector for rail-mount terminal blocks; 0.6 x 1 mm pins; angled; 100% protected against mismatching; Pin spacing 5 mm; 6-pole; light gray

www.wago.com/722-236/005-000



Nr. articol: 722-236/005-000/039-000

Female connector for rail-mount terminal blocks; 0.6 x 1 mm pins; angled; 100% protected against mismatching; Locking lever; Pin spacing 5 mm; 6-pole; light gray













www.wago.com/722-236/005-000/039-000

Nr. articol: 722-237/005-000

Supus modificărilor.

WAGO Kontakttechnik GmbH & Co. KG
/Representative Office Romania
Sos. Pipera-Tunari nr. 1/1
building 1, 2nd floor | 077190 Voluntari, Ilfov
Tel.: +40-(0)31 421 85 68 | Email: info-RO@wago.com

Aveți întrebări despre produsele noastre?
Vă stăm la dispoziție pentru preluarea apelului la +40 (0) 31 421 85 68.

| | | |
|--|---|--|
|  | Female connector for rail-mount terminal blocks; 0.6 x 1 mm pins; angled; 100% protected against mismatching; Pin spacing 5 mm; 7-pole; light gray | www.wago.com/722-237/005-000 |
|  | Nr. articol: 722-237/005-000/039-000 Female connector for rail-mount terminal blocks; 0.6 x 1 mm pins; angled; 100% protected against mismatching; Locking lever; Pin spacing 5 mm; 7-pole; light gray | www.wago.com/722-237/005-000/039-000 |
|  | Nr. articol: 722-238/005-000 Female connector for rail-mount terminal blocks; 0.6 x 1 mm pins; angled; 100% protected against mismatching; Pin spacing 5 mm; 8-pole; light gray | www.wago.com/722-238/005-000 |
|  | Nr. articol: 722-239/005-000 Female connector for rail-mount terminal blocks; 0.6 x 1 mm pins; angled; 100% protected against mismatching; Pin spacing 5 mm; 9-pole; light gray | www.wago.com/722-239/005-000 |
|  | Nr. articol: 722-239/005-000/039-000 Female connector for rail-mount terminal blocks; 0.6 x 1 mm pins; angled; 100% protected against mismatching; Locking lever; Pin spacing 5 mm; 9-pole; light gray | www.wago.com/722-239/005-000/039-000 |
|  | Nr. articol: 722-240/005-000 Female connector for rail-mount terminal blocks; 0.6 x 1 mm pins; angled; 100% protected against mismatching; Pin spacing 5 mm; 10-pole; light gray | www.wago.com/722-240/005-000 |
|  | Nr. articol: 722-240/005-000/039-000 Female connector for rail-mount terminal blocks; 0.6 x 1 mm pins; angled; 100% protected against mismatching; Locking lever; Pin spacing 5 mm; 10-pole; light gray | www.wago.com/722-240/005-000/039-000 |
|  | Nr. articol: 722-241/005-000 Female connector for rail-mount terminal blocks; 0.6 x 1 mm pins; angled; 100% protected against mismatching; Pin spacing 5 mm; 11-pole; light gray | www.wago.com/722-241/005-000 |
|  | Nr. articol: 722-242/005-000 Female connector for rail-mount terminal blocks; 0.6 x 1 mm pins; angled; 100% protected against mismatching; Pin spacing 5 mm; 12-pole; light gray | www.wago.com/722-242/005-000 |
|  | Nr. articol: 722-242/005-000/039-000 Female connector for rail-mount terminal blocks; 0.6 x 1 mm pins; angled; 100% protected against mismatching; Locking lever; Pin spacing 5 mm; 12-pole; light gray | www.wago.com/722-242/005-000/039-000 |
|  | Nr. articol: 722-243/005-000 Female connector for rail-mount terminal blocks; 0.6 x 1 mm pins; angled; 100% protected against mismatching; Pin spacing 5 mm; 13-pole; light gray | www.wago.com/722-243/005-000 |
|  | Nr. articol: 722-244/005-000 Female connector for rail-mount terminal blocks; 0.6 x 1 mm pins; angled; 100% protected against mismatching; Pin spacing 5 mm; 14-pole; light gray | www.wago.com/722-244/005-000 |
|  | Nr. articol: 722-244/005-000/039-000 Female connector for rail-mount terminal blocks; 0.6 x 1 mm pins; angled; 100% protected against mismatching; Locking lever; Pin spacing 5 mm; 14-pole; light gray | www.wago.com/722-244/005-000/039-000 |

Nr. articol: 722-246/005-000

Supus modificărilor.

WAGO Kontakttechnik GmbH & Co. KG
/Representative Office Romania
Sos. Pipera-Tunari nr. 1/1
building 1, 2nd floor | 077190 Voluntari, Ilfov
Tel.: +40-(0)31 421 85 68 | Email: info-RO@wago.com

Aveți întrebări despre produsele noastre?
Vă stăm la dispoziție pentru preluarea apelului la +40 (0) 31 421 85 68.



Female connector for rail-mount terminal blocks; 0.6 x 1 mm pins; angled; 100% protected against mismatching; Pin spacing 5 mm; 16-pole; light gray

www.wago.com/722-246/005-000



Nr. articol: 722-246/005-000/039-000

Female connector for rail-mount terminal blocks; 0.6 x 1 mm pins; angled; 100% protected against mismatching; Locking lever; Pin spacing 5 mm; 16-pole; light gray

www.wago.com/722-246/005-000/039-000



Nr. articol: 722-250/005-000

Female connector for rail-mount terminal blocks; 0.6 x 1 mm pins; angled; 100% protected against mismatching; Pin spacing 5 mm; 20-pole; light gray

www.wago.com/722-250/005-000

Carrier rail



Nr. articol: 210-112

Steel carrier rail; 35 x 7.5 mm; 1 mm thick; 2 m long; slotted; according to EN 60715; "Hole width 25 mm

www.wago.com/210-112

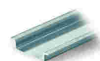

Nr. articol: 210-113

Steel carrier rail; 35 x 7.5 mm; 1 mm thick; 2 m long; unslotted; according to EN 60715

www.wago.com/210-113



Nr. articol: 210-114

Steel carrier rail; 35 x 15 mm; 1.5 mm thick; 2 m long; unslotted; similar to EN 60715

www.wago.com/210-114



Nr. articol: 210-115

Steel carrier rail; 35 x 7.5 mm; 1 mm thick; 2 m long; slotted; according to EN 60715; "Hole width 18 mm

www.wago.com/210-115



Nr. articol: 210-118

Steel carrier rail; 35 x 15 mm; 2.3 mm thick; 2 m long; unslotted; according to EN 60715

www.wago.com/210-118



Nr. articol: 210-196

Aluminum carrier rail; 35 x 8.2 mm; 1.6 mm thick; 2 m long; unslotted; similar to EN 60715; silver-colored

www.wago.com/210-196



Nr. articol: 210-197

Steel carrier rail; 35 x 15 mm; 1.5 mm thick; 2 m long; slotted; similar to EN 60715

www.wago.com/210-197



Nr. articol: 210-198

Copper carrier rail; 35 x 15 mm; 2.3 mm thick; 2 m long; unslotted; according to EN 60715; copper-colored

www.wago.com/210-198



Nr. articol: 210-504

Steel carrier rail; 35 x 7.5 mm; 1 mm thick; 2 m long; slotted; galvanized; according to EN 60715

www.wago.com/210-504

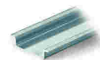

Nr. articol: 210-505

Steel carrier rail; 35 x 7.5 mm; 1 mm thick; 2 m long; unslotted; galvanized; according to EN 60715

www.wago.com/210-505



Nr. articol: 210-506

Steel carrier rail; 35 x 15 mm; 1.5 mm thick; 2 m long; unslotted; galvanized; similar to EN 60715

www.wago.com/210-506



Nr. articol: 210-508

Steel carrier rail; 35 x 15 mm; 1.5 mm thick; 2 m long; slotted; galvanized; similar to EN 60715

www.wago.com/210-508

End plate

















Nr. articol: 209-191

Separator for Ex e/Ex i applications; 3 mm thick; 120 mm wide; orange

www.wago.com/209-191

Supus modificărilor.

| | | |
|--|--|--|
|  | Nr. articol: 209-192 Separator for Ex e/Ex i applications; 3 mm thick; 125.5 mm wide; orange | www.wago.com/209-192 |
|  | Nr. articol: 280-354 End and intermediate plate; 2.5 mm thick; light gray | www.wago.com/280-354 |
|  | Nr. articol: 280-355 Separator plate; 2.5 mm thick; oversized; light gray | www.wago.com/280-355 |
| Marking accessories | | |
|  | Nr. articol: 2009-115 WMB-Inline; for Smart Printer; 1500 pieces on roll; stretchable 5 - 5.2 mm; plain; snap-on type; white | www.wago.com/2009-115 |
|  | Nr. articol: 2009-115/000-002 WMB-Inline; for Smart Printer; 1500 pieces on roll; stretchable 5 - 5.2 mm; plain; snap-on type; yellow | www.wago.com/2009-115/000-002 |
|  | Nr. articol: 2009-115/000-006 WMB-Inline; for Smart Printer; 1500 pieces on roll; stretchable 5 - 5.2 mm; plain; snap-on type; blue | www.wago.com/2009-115/000-006 |
|  | Nr. articol: 2009-115/000-007 WMB-Inline; for Smart Printer; 1500 pieces on roll; stretchable 5 - 5.2 mm; plain; snap-on type; gray | www.wago.com/2009-115/000-007 |
|  | Nr. articol: 2009-115/000-012 WMB-Inline; for Smart Printer; 1500 pieces on roll; stretchable 5 - 5.2 mm; plain; snap-on type; orange | www.wago.com/2009-115/000-012 |
|  | Nr. articol: 2009-115/000-017 WMB-Inline; for Smart Printer; 1500 pieces on roll; stretchable 5 - 5.2 mm; plain; snap-on type; light green | www.wago.com/2009-115/000-017 |
|  | Nr. articol: 2009-115/000-023 WMB-Inline; for Smart Printer; 1500 pieces on roll; stretchable 5 - 5.2 mm; plain; snap-on type; green | www.wago.com/2009-115/000-023 |
|  | Nr. articol: 2009-115/000-024 WMB-Inline; for Smart Printer; 1500 pieces on roll; stretchable 5 - 5.2 mm; plain; snap-on type; violet | www.wago.com/2009-115/000-024 |
|  | Nr. articol: 209-128 Adaptor; gray | www.wago.com/209-128 |
|  | Nr. articol: 209-140 Group marker carrier; gray | www.wago.com/209-140 |
|  | Nr. articol: 209-141 Group marker carrier; gray | www.wago.com/209-141 |
|  | Nr. articol: 209-142 Group marker carrier; gray | www.wago.com/209-142 |

Supus modificărilor.



Nr. articol: 209-185
Adaptor; gray

www.wago.com/209-185



Nr. articol: 210-612
Marking strips; for self-marking; plain; Self-adhesive; transparent

www.wago.com/210-612



Nr. articol: 249-105
Group marker carrier; gray

www.wago.com/249-105



Nr. articol: 793-501
WMB marking card; as card; not stretchable; plain; snap-on type; white

www.wago.com/793-501



Nr. articol: 793-501/000-002
WMB marking card; as card; not stretchable; plain; snap-on type; yellow

www.wago.com/793-501/000-002



Nr. articol: 793-501/000-005
WMB marking card; as card; not stretchable; plain; snap-on type; red

www.wago.com/793-501/000-005



Nr. articol: 793-501/000-006
WMB marking card; as card; not stretchable; plain; snap-on type; blue

www.wago.com/793-501/000-006



Nr. articol: 793-501/000-007
WMB marking card; as card; not stretchable; plain; snap-on type; gray

www.wago.com/793-501/000-007



Nr. articol: 793-501/000-012
WMB marking card; as card; not stretchable; plain; snap-on type; orange

www.wago.com/793-501/000-012



Nr. articol: 793-501/000-017
WMB marking card; as card; not stretchable; plain; snap-on type; light green

www.wago.com/793-501/000-017



Nr. articol: 793-501/000-023
WMB marking card; as card; not stretchable; plain; snap-on type; green

www.wago.com/793-501/000-023



Nr. articol: 793-501/000-024
WMB marking card; as card; not stretchable; plain; snap-on type; violet

www.wago.com/793-501/000-024



Nr. articol: 793-5501
WMB marking card; as card; for terminal block width 5 - 17.5 mm; stretchable 5 - 5.2 mm; plain; snap-on type; white

www.wago.com/793-5501



Nr. articol: 793-5501/000-002
WMB marking card; as card; for terminal block width 5 - 17.5 mm; stretchable 5 - 5.2 mm; plain; snap-on type; yellow

www.wago.com/793-5501/000-002

Nr. articol: 793-5501/000-005
WMB marking card; as card; for terminal block width 5 - 17.5 mm; stretchable 5 - 5.2 mm; plain; snap-

Supus modificărilor.



on type; red

www.wago.com/793-5501/000-005
**Nr. articol: 793-5501/000-006**

WMB marking card; as card; for terminal block width 5 - 17.5 mm; stretchable 5 - 5.2 mm; plain; snap-on type; blue

www.wago.com/793-5501/000-006
**Nr. articol: 793-5501/000-007**

WMB marking card; as card; for terminal block width 5 - 17.5 mm; stretchable 5 - 5.2 mm; plain; snap-on type; gray

www.wago.com/793-5501/000-007
**Nr. articol: 793-5501/000-012**

WMB marking card; as card; for terminal block width 5 - 17.5 mm; stretchable 5 - 5.2 mm; plain; snap-on type; orange

www.wago.com/793-5501/000-012
**Nr. articol: 793-5501/000-017**

WMB marking card; as card; for terminal block width 5 - 17.5 mm; stretchable 5 - 5.2 mm; plain; snap-on type; green

www.wago.com/793-5501/000-017
**Nr. articol: 793-5501/000-023**

WMB marking card; as card; for terminal block width 5 - 17.5 mm; stretchable 5 - 5.2 mm; plain; snap-on type; light green

www.wago.com/793-5501/000-023
**Nr. articol: 793-5501/000-024**













WMB marking card; as card; for terminal block width 5 - 17.5 mm; stretchable 5 - 5.2 mm; plain; snap-on type; violet

www.wago.com/793-5501/000-024















ferrule

**Nr. articol: 216-101**Ferrule; Sleeve for 0.5 mm² / AWG 22; uninsulated; electro-tin plated
www.wago.com/216-101
**Nr. articol: 216-102**Ferrule; Sleeve for 0.75 mm² / AWG 20; uninsulated; electro-tin plated
www.wago.com/216-102
**Nr. articol: 216-103**Ferrule; Sleeve for 1 mm² / AWG 18; uninsulated; electro-tin plated
www.wago.com/216-103
**Nr. articol: 216-104**Ferrule; Sleeve for 1.5 mm² / AWG 16; uninsulated; electro-tin plated
www.wago.com/216-104
**Nr. articol: 216-201**Ferrule; Sleeve for 0.5 mm² / 20 AWG; insulated; electro-tin plated; white
www.wago.com/216-201
**Nr. articol: 216-202**Ferrule; Sleeve for 0.75 mm² / 18 AWG; insulated; electro-tin plated; gray
www.wago.com/216-202
**Nr. articol: 216-203**Ferrule; Sleeve for 1 mm² / AWG 18; insulated; electro-tin plated; red
www.wago.com/216-203
**Nr. articol: 216-204**Ferrule; Sleeve for 1.5 mm² / AWG 16; insulated; electro-tin plated; black
www.wago.com/216-204

Supus modificărilor.

| | | |
|--|--|--|
| | Nr. articol: 216-301 Ferrule; Sleeve for 0.25 mm ² / AWG 24; insulated; electro-tin plated; yellow | www.wago.com/216-301 |
|  | Nr. articol: 216-302 Ferrule; Sleeve for 0.34 mm ² / 22 AWG; insulated; electro-tin plated; green | www.wago.com/216-302 |
| assembling | | |
|  | Nr. articol: 209-106 Mounting carrier; for isolated mounting on DIN 35 rails; gray | www.wago.com/209-106 |
| General accessories | | |
|  | Nr. articol: 231-162/003-000 Male connector for rail-mount terminal blocks; 1.2 x 1.2 mm pins; straight; Pin spacing 5 mm; 2-pole; gray | www.wago.com/231-162/003-000 |
|  | Nr. articol: 231-163/003-000 Male connector for rail-mount terminal blocks; 1.2 x 1.2 mm pins; straight; Pin spacing 5 mm; 3-pole; gray | www.wago.com/231-163/003-000 |
|  | Nr. articol: 231-164/003-000 Male connector for rail-mount terminal blocks; 1.2 x 1.2 mm pins; straight; Pin spacing 5 mm; 4-pole; gray | www.wago.com/231-164/003-000 |
|  | Nr. articol: 231-165/003-000 Male connector for rail-mount terminal blocks; 1.2 x 1.2 mm pins; straight; Pin spacing 5 mm; 5-pole; gray | www.wago.com/231-165/003-000 |
|  | Nr. articol: 231-166/003-000 Male connector for rail-mount terminal blocks; 1.2 x 1.2 mm pins; straight; Pin spacing 5 mm; 6-pole; gray | www.wago.com/231-166/003-000 |
|  | Nr. articol: 231-167/003-000 Male connector for rail-mount terminal blocks; 1.2 x 1.2 mm pins; straight; Pin spacing 5 mm; 7-pole; gray | www.wago.com/231-167/003-000 |
|  | Nr. articol: 231-168/003-000 Male connector for rail-mount terminal blocks; 1.2 x 1.2 mm pins; straight; Pin spacing 5 mm; 8-pole; gray | www.wago.com/231-168/003-000 |
|  | Nr. articol: 231-169/003-000 Male connector for rail-mount terminal blocks; 1.2 x 1.2 mm pins; straight; Pin spacing 5 mm; 9-pole; gray | www.wago.com/231-169/003-000 |
|  | Nr. articol: 231-170/003-000 Male connector for rail-mount terminal blocks; 1.2 x 1.2 mm pins; straight; Pin spacing 5 mm; 10-pole; gray | www.wago.com/231-170/003-000 |
|  | Nr. articol: 231-171/003-000 Male connector for rail-mount terminal blocks; 1.2 x 1.2 mm pins; straight; Pin spacing 5 mm; 11-pole; gray | www.wago.com/231-171/003-000 |
| | Nr. articol: 231-172/003-000 Male connector for rail-mount terminal blocks; 1.2 x 1.2 mm pins; straight; Pin spacing 5 mm; 12-pole; | |

Supus modificărilor.

| | | |
|--|--|--|
|  | gray | www.wago.com/231-172/003-000 |
|  | Nr. articol: 231-176/003-000 Male connector for rail-mount terminal blocks; 1.2 x 1.2 mm pins; straight; Pin spacing 5 mm; 16-pole; gray | www.wago.com/231-176/003-000 |
|  | Nr. articol: 231-180/003-000 Male connector for rail-mount terminal blocks; 1.2 x 1.2 mm pins; straight; Pin spacing 5 mm; 20-pole; gray | www.wago.com/231-180/003-000 |
|  | Nr. articol: 231-668 Lockout caps; for covering unused clamping units; gray | www.wago.com/231-668 |
|  | Nr. articol: 231-669 Lockout caps; for covering unused clamping units; orange | www.wago.com/231-669 |
|  | Nr. articol: 721-162/003-000 Male connector for rail-mount terminal blocks; 1.2 x 1.2 mm pins; straight; 100% protected against mismatching; Pin spacing 5 mm; 2-pole; light gray | www.wago.com/721-162/003-000 |
|  | Nr. articol: 721-163/003-000 Male connector for rail-mount terminal blocks; 1.2 x 1.2 mm pins; straight; 100% protected against mismatching; Pin spacing 5 mm; 3-pole; light gray | www.wago.com/721-163/003-000 |
|  | Nr. articol: 721-164/003-000 Male connector for rail-mount terminal blocks; 1.2 x 1.2 mm pins; straight; 100% protected against mismatching; Pin spacing 5 mm; 4-pole; light gray | www.wago.com/721-164/003-000 |
|  | Nr. articol: 721-165/003-000 Male connector for rail-mount terminal blocks; 1.2 x 1.2 mm pins; straight; 100% protected against mismatching; Pin spacing 5 mm; 5-pole; light gray | www.wago.com/721-165/003-000 |
|  | Nr. articol: 721-166/003-000 Male connector for rail-mount terminal blocks; 1.2 x 1.2 mm pins; straight; 100% protected against mismatching; Pin spacing 5 mm; 6-pole; light gray | www.wago.com/721-166/003-000 |
|  | Nr. articol: 721-167/003-000 Male connector for rail-mount terminal blocks; 1.2 x 1.2 mm pins; straight; 100% protected against mismatching; Pin spacing 5 mm; 7-pole; light gray | www.wago.com/721-167/003-000 |
|  | Nr. articol: 721-168/003-000 Male connector for rail-mount terminal blocks; 1.2 x 1.2 mm pins; straight; 100% protected against mismatching; Pin spacing 5 mm; 8-pole; light gray | www.wago.com/721-168/003-000 |
|  | Nr. articol: 721-169/003-000 Male connector for rail-mount terminal blocks; 1.2 x 1.2 mm pins; straight; 100% protected against mismatching; Pin spacing 5 mm; 9-pole; light gray | www.wago.com/721-169/003-000 |
|  | Nr. articol: 721-170/003-000 Male connector for rail-mount terminal blocks; 1.2 x 1.2 mm pins; straight; 100% protected against mismatching; Pin spacing 5 mm; 10-pole; light gray | www.wago.com/721-170/003-000 |

Supus modificărilor.

WAGO Kontakttechnik GmbH & Co. KG
/Representative Office Romania
Sos. Pipera-Tunari nr. 1/1
building 1, 2nd floor | 077190 Voluntari, Ilfov
Tel.: +40-(0)31 421 85 68 | Email: info-RO@wago.com

Aveți întrebări despre produsele noastre?
Vă stăm la dispoziție pentru preluarea apelului la +40 (0) 31 421 85 68.

**Nr. articol: 721-171/003-000**

Male connector for rail-mount terminal blocks; 1.2 x 1.2 mm pins; straight; 100% protected against mismatching; Pin spacing 5 mm; 11-pole; light gray

www.wago.com/721-171/003-000

**Nr. articol: 721-172/003-000**

Male connector for rail-mount terminal blocks; 1.2 x 1.2 mm pins; straight; 100% protected against mismatching; Pin spacing 5 mm; 12-pole; light gray

www.wago.com/721-172/003-000

**Nr. articol: 721-173/003-000**

Male connector for rail-mount terminal blocks; 1.2 x 1.2 mm pins; straight; 100% protected against mismatching; Pin spacing 5 mm; 13-pole; light gray

www.wago.com/721-173/003-000

**Nr. articol: 721-174/003-000**

Male connector for rail-mount terminal blocks; 1.2 x 1.2 mm pins; straight; 100% protected against mismatching; Pin spacing 5 mm; 14-pole; light gray

www.wago.com/721-174/003-000

**Nr. articol: 721-175/003-000**

Male connector for rail-mount terminal blocks; 1.2 x 1.2 mm pins; straight; 100% protected against mismatching; Pin spacing 5 mm; 15-pole; light gray

www.wago.com/721-175/003-000

**Nr. articol: 721-176/003-000**

Male connector for rail-mount terminal blocks; 1.2 x 1.2 mm pins; straight; 100% protected against mismatching; Pin spacing 5 mm; 16-pole; light gray

www.wago.com/721-176/003-000

**Nr. articol: 721-180/003-000**

Male connector for rail-mount terminal blocks; 1.2 x 1.2 mm pins; straight; 100% protected against mismatching; Pin spacing 5 mm; 20-pole; light gray

www.wago.com/721-180/003-000

Insulation stop**Nr. articol: 280-470**

Insulation stop; 0.08 - 0.2 mm² "s" (0.14 mm² "f-st"); 5 pieces/strip; white

www.wago.com/280-470

**Nr. articol: 280-471**

Insulation stop; 0.25 - 0.5 mm²; 5 pieces/strip; light gray

www.wago.com/280-471

**Nr. articol: 280-472**

Insulation stop; 0.75 - 1 mm²; 5 pieces/strip

www.wago.com/280-472

tools**Nr. articol: 210-657**

Operating tool; Blade: 3.5 x 0.5 mm; with a partially insulated shaft; short

www.wago.com/210-657

**Nr. articol: 210-658**

Operating tool; Blade: 3.5 x 0.5 mm; with a partially insulated shaft; angled; short

www.wago.com/210-658

**Nr. articol: 210-720**

Operating tool; Blade: 3.5 x 0.5 mm; with a partially insulated shaft

www.wago.com/210-720

Supus modificărilor.



Descărcări Documentation

Additional Information

| | | | |
|------------------------|-------------|---------------|------------|
| Technical explanations | Apr 3, 2019 | pdf 2,1 MB | Descărcare |
|------------------------|-------------|---------------|------------|

CAD/CAE-Data

CAD data

| | | |
|----------------------|-----|------------|
| 2D/3D Models 280-998 | URL | Descărcare |
|----------------------|-----|------------|

CAE data

| | | |
|---------------------------|-----|------------|
| EPLAN Data Portal 280-998 | URL | Descărcare |
|---------------------------|-----|------------|

| | | |
|------------------------|-----|------------|
| WSCAD Universe 280-998 | URL | Descărcare |
|------------------------|-----|------------|

Installation Notes

Assembly

Supus modificărilor.

WAGO Kontakttechnik GmbH & Co. KG
/Representative Office Romania
Sos. Pipera-Tunari nr. 1/1
building 1, 2nd floor | 077190 Voluntari, Ilfov
Tel.: +40-(0)31 421 85 68 | Email: info-RO@wago.com

Aveți întrebări despre produsele noastre?
Vă stăm la dispoziție pentru preluarea apelului la +40 (0) 31 421 85 68.

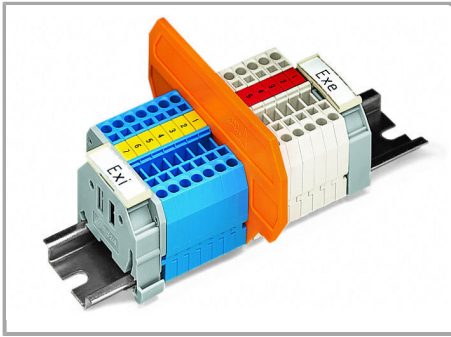

Separator for Ex e/Ex i applications

According to EN 50020, a minimum distance of 50 mm must be kept between live parts of Ex e and Ex i circuits. The use of Ex e/Ex i separators is a space-saving solution when Ex e and Ex i terminal blocks are mounted on a common carrier rail.

Compatible with 279 to 282 Series:

209-190 for 2-conductor terminal blocks

209-191 for 2-, 3-, 4-conductor terminal blocks

Inserting a conductor

Supus modificărilor.

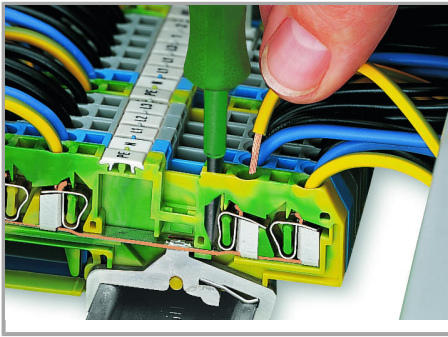

CAGE CLAMP® connection

Inserting a conductor.



CAGE CLAMP® connection

Inserting a conductor.

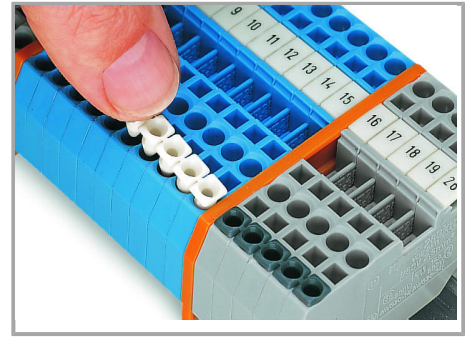

Inserting insulation stops.

With ferruled conductors, it is necessary to use a terminal block one size larger than the conductor's nominal cross-section.

Commoning

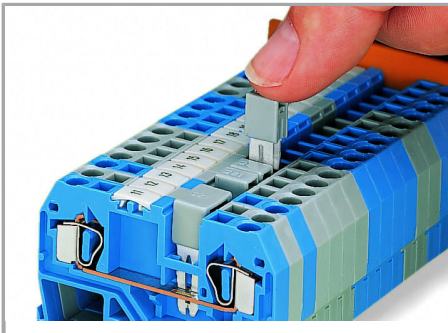

Commoning using an adjacent jumper (280-402).

Push jumper down until fully inserted.

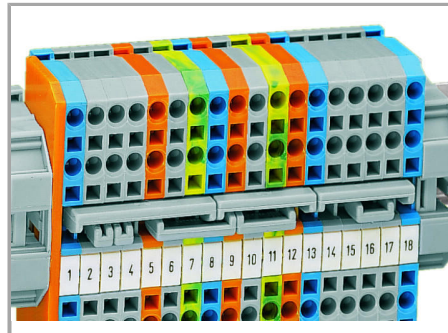

Staggered jumpers for sophisticated circuit requirements – push jumpers down until fully inserted.

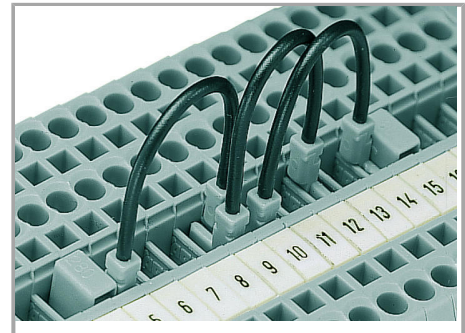

Wire jumpers

When installing machines or control systems, it is often necessary to make an additional connection between two terminal blocks that are not next to each other on the rail. In such cases, WAGO's touch-proof, push-in type wire jumpers are the ideal solution.

Supus modificărilor.



These jumpers are compatible with the following rail-mount terminal blocks:

- 279 Series (1.5 mm²/16 AWG),
-
- 280/775/780 Series (2.5 mm²/14 AWG)
-
- 281/769/776/777/781 and 880 Series (4 mm²/12 AWG)
-

They are available in three conductor lengths (60, 110 and 250 mm), allowing up to 60 terminal blocks to be commoned depending on their width (see table on the right).

Compared with the 279 Series, the 280/775/780 and 281/776/777/781 Series can also accommodate two wire jumpers, allowing the use of commoning chains. Furthermore, the 280/769/775/780/880 and 281/776/777/781 Series allow both wire jumper and adjacent jumper to be simultaneously plugged into a same terminal block.

Supus modificărilor.