

Fișă tehnică | Număr articol: 721-139/001-000

THT male header; 1.0 x 1.0 mm solder pin; straight; 100% protected against mismatching; Pin spacing 5 mm; 9-pole; light gray

www.wago.com/721-139/001-000

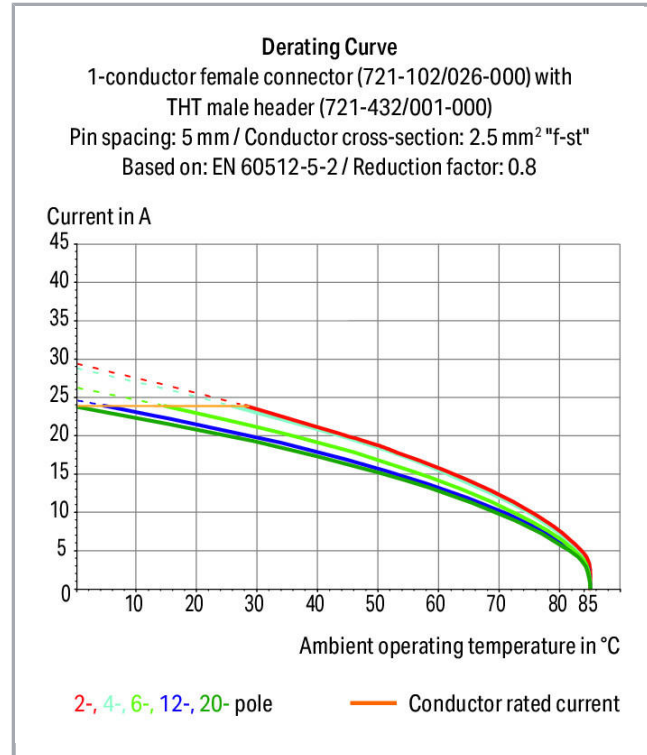

Supus modificărilor.

WAGO Kontakttechnik GmbH & Co. KG
/Representative Office Romania
Sos. Pipera-Tunari nr. 1/1
building 1, 2nd floor | 077190 Voluntari, Ilfov
Tel.: +40-(0)31 421 85 68 | Email: info-RO@wago.com

Aveți întrebări despre produsele noastre?
Vă stăm la dispoziție pentru preluarea apelului la +40 (0) 31 421 85 68.

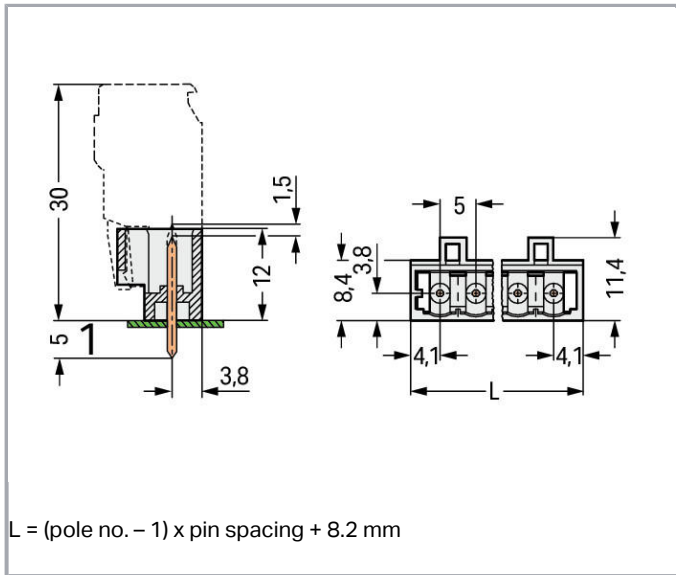

Descriere articol

- Horizontal or vertical PCB mounting via straight or angled solder pins
- Pin cross-section: 1 x 1 mm
- 100 % protected against mismatching
- With coding fingers

Safety information 1:

The *MULTI CONNECTION SYSTEM (MCS)* is designed without breaking capacity for compliance with DIN EN 61984. When used as intended, MCS Connectors shall not be connected/disconnected when live or under load. The circuit design should ensure header pins, which can be touched, are not live when unmated.

Date

Electrical data

Ratings per IEC/EN 60664-1

Ratings per	IEC/EN 60664-1
Nominal voltage (III/3)	320 V
Rated surge voltage (III/3)	4 kV
Rated voltage (III/2)	320 V
Rated surge voltage (III/2)	4 kV
Nominal voltage (II/2)	630 V
Rated surge voltage (II/2)	4 kV

Supus modificărilor.

WAGO Kontakttechnik GmbH & Co. KG
 /Representative Office Romania
 Sos. Pipera-Tunari nr. 1/1
 building 1, 2nd floor | 077190 Voluntari, Ilfov
 Tel.: +40-(0)31 421 85 68 | Email: info-RO@wago.com

Aveți întrebări despre produsele noastre?
 Vă stăm la dispoziție pentru preluarea apelului la +40 (0) 31 421 85 68.



Rated current	12 A
Legend (ratings)	(III / 2) $\hat{=}$ Overvoltage category III / Pollution degree 2

Approvals per UL 1059

Rated voltage UL (Use Group B)	300 V
Rated current UL (Use Group B)	10 A
Rated voltage UL (Use Group D)	300 V
Rated current UL (Use Group D)	10 A
Approvals per	UL 1059

Approvals per UL 1977

Rated voltage UL 1977	600 V
Rated current UL 1977	10 A

Approvals per CSA

Rated voltage CSA (Use Group B)	300 V
Rated current CSA (Use Group B)	10 A
Rated voltage CSA (Use Group D)	300 V
Rated current CSA (Use Group D)	10 A

Connection data

Pole No.	9
Total number of potentials	9
Number of connection types	1
Number of levels	1

Geometrical Data

Pin spacing	5 mm / 0.197 inch
Width	48.2 mm / 1.898 inch
Height	17 mm / 0.669 inch
Height from the surface	12 mm / 0.472 inch
Depth	11.4 mm / 0.449 inch
Solder pin length	5 mm
Solder pin dimensions	1 x 1 mm
Drilled hole diameter with tolerance	1.4 ^(+0.1) mm

Supus modificărilor.

WAGO Kontakttechnik GmbH & Co. KG
 /Representative Office Romania
 Sos. Pipera-Tunari nr. 1/1
 building 1, 2nd floor | 077190 Voluntari, Ilfov
 Tel.: +40-(0)31 421 85 68 | Email: info-RO@wago.com

Aveți întrebări despre produsele noastre?
 Vă stăm la dispoziție pentru preluarea apelului la +40 (0) 31 421 85 68.



Plug connection

Contact type (pluggable connector)	Male connector/plug
Connector (connection type)	for PCBs
Mismating protection	Yes
Mating direction to the PCB	90°

PCB contact

PCB contact	THT
Solder pin arrangement	over the entire male connector, in line
Number of solder pins per potential	1

Material Data

Color	light gray
Material group	I
Insulation material	Polyamide 66 (PA 66)
Flammability class per UL94	V0
Contact material	Electrolytic copper (E _{Cu})
Contact plating	tin-plated
Fire load	0,053 MJ
Weight	2,9 g

Environmental Requirements

Limit temperature range	-60 ... +100 °C
-------------------------	-----------------

Commercial data

Product Group	3 (Multi Conn. System)
Packaging type	BOX
Country of origin	PL
GTIN	4044918869027
Customs tariff number	85366990990

Aprobări / certificate

Country specific Approvals

Emblemă	Aprobare	Text de aprobare suplimentar	Nume certificat
	CSA	C22.2	1466354

Supus modificărilor.

WAGO Kontakttechnik GmbH & Co. KG
 /Representative Office Romania
 Sos. Pipera-Tunari nr. 1/1
 building 1, 2nd floor | 077190 Voluntari, Ilfov
 Tel.: +40-(0)31 421 85 68 | Email: info-RO@wago.com

Aveți întrebări despre produsele noastre?
 Vă stăm la dispoziție pentru preluarea apelului la +40 (0) 31 421 85 68.



DEKRA Certification B.V.





KEMA/KEUR

DEKRA Certification B.V.



EN 61984

2190761.01

Ship Approvals

Emblemă	Aprobare	Text de aprobare suplimentar	Nume certificat
	ABS American Bureau of Shipping	-	19- HG1869876- PDA
	DNV GL Det Norske Veritas, Germanischer Lloyd	-	TAE000016Z

UL-Approvals

Emblemă	Aprobare	Text de aprobare suplimentar	Nume certificat
	UL Underwriters Laboratories Inc.	UL 1059	20190731- E45172
	UR UL International Germany GmbH	UL 1977	E45171

Counterpart



Nr. articol 721-109/026-000

1-conductor female plug; 100% protected against mismatching; 2.5 mm²; Pin spacing 5 mm; 9-pole; 2,50 mm²; light graywww.wago.com/721-109/026-000

Nr. articol 2721-109/026-000

1-conductor female plug; 100% protected against mismatching; push-button; 2.5 mm²; Pin spacing 5 mm; 9-pole; 2,50 mm²; light graywww.wago.com/2721-109/026-000











Nr. articol 2721-109/031-000

www.wago.com/2721-109/031-000

Supus modificărilor.

WAGO Kontakttechnik GmbH & Co. KG
/Representative Office Romania
Sos. Pipera-Tunari nr. 1/1
building 1, 2nd floor | 077190 Voluntari, Ilfov
Tel.: +40-(0)31 421 85 68 | Email: info-RO@wago.com

Aveți întrebări despre produsele noastre?
Vă stăm la dispoziție pentru preluarea apelului la +40 (0) 31 421 85 68.

	1-conductor female plug; 100% protected against mismatching; push-button; clamping collar; 2.5 mm ² ; Pin spacing 5 mm; 9-pole; 2,50 mm ² ; light gray	109/031-000
	Nr. articol 721-109/037-000 1-conductor female plug; 100% protected against mismatching; push-button; Locking lever; 2.5 mm ² ; Pin spacing 5 mm; 9-pole; 2,50 mm ² ; light gray	www.wago.com/721-109/037-000
	Nr. articol 721-109/031-000 1-conductor female plug; 100% protected against mismatching; clamping collar; 2.5 mm ² ; Pin spacing 5 mm; 9-pole; 2,50 mm ² ; light gray	www.wago.com/721-109/031-000
	Nr. articol 721-109/027-000 1-conductor female plug; 100% protected against mismatching; clamping collar; 2.5 mm ² ; Pin spacing 5 mm; 9-pole; 2,50 mm ² ; light gray	www.wago.com/721-109/027-000
	Nr. articol 721-309/008-000 1-conductor female plug; angled; 100% protected against mismatching; Snap-in mounting feet; 2.5 mm ² ; Pin spacing 5 mm; 9-pole; 2,50 mm ² ; light gray	www.wago.com/721-309/008-000
	Nr. articol 721-109/037-000 1-conductor female plug; 100% protected against mismatching; Locking lever; 2.5 mm ² ; Pin spacing 5 mm; 9-pole; 2,50 mm ² ; light gray	www.wago.com/721-109/037-000
	Nr. articol 721-2109/026-000 2-conductor female connector; 100% protected against mismatching; 2.5 mm ² ; Pin spacing 5 mm; 9-pole; 2,50 mm ² ; light gray	www.wago.com/721-2109/026-000
	Nr. articol 721-2109/037-000 2-conductor female connector; 100% protected against mismatching; Locking lever; 2.5 mm ² ; Pin spacing 5 mm; 9-pole; 2,50 mm ² ; light gray	www.wago.com/721-2109/037-000
	Nr. articol 722-109/026-000 1-conductor female plug; angled; 100% protected against mismatching; 2,50 mm ² ; light gray	www.wago.com/722-109/026-000
	Nr. articol 721-309/031-000 1-conductor female plug; angled; 100% protected against mismatching; clamping collar; 2.5 mm ² ; Pin spacing 5 mm; 9-pole; 2,50 mm ² ; light gray	www.wago.com/721-309/031-000
	Nr. articol 722-209/026-000 1-conductor female plug; angled; 100% protected against mismatching; 2.5 mm ² ; Pin spacing 5 mm; 9-pole; 2,50 mm ² ; light gray	www.wago.com/722-209/026-000

Produse compatibile

Coding



	Nr. articol: 231-129 Coding key; snap-on type; light gray	www.wago.com/231-129
--	---	--

Supus modificărilor.

WAGO Kontakttechnik GmbH & Co. KG
/Representative Office Romania
Sos. Pipera-Tunari nr. 1/1
building 1, 2nd floor | 077190 Voluntari, Ilfov
Tel.: +40-(0)31 421 85 68 | Email: info-RO@wago.com

Aveți întrebări despre produsele noastre?
Vă stăm la dispoziție pentru preluarea apelului la +40 (0) 31 421 85 68.

Marking accessories

	Nr. articol: 210-833 Marking strips; on reel; 6 mm wide; plain; Self-adhesive; white	www.wago.com/210-833
	Nr. articol: 210-834 Marking strips; on reel; 5 mm wide; plain; Self-adhesive; white	www.wago.com/210-834

Descărcări

Documentation

Additional Information

Technical explanations	Apr 3, 2019	pdf 3,6 MB	Descărcare
------------------------	-------------	---------------	------------

CAD/CAE-Data

CAD data

2D/3D Models 721-139/001-000	URL	Descărcare
------------------------------	-----	------------

CAE data

EPLAN Data Portal 721-139/001-000	URL	Descărcare
-----------------------------------	-----	------------

PCB Design

Symbol and Footprint 721-139/001-000	URL	Descărcare
--------------------------------------	-----	------------

CAX data for your PCB design, consisting of "schematic symbols and PCB footprints", allow easy integration of the WAGO component into your development environment.

Supported formats:

- Accel EDA 14 & 15
- Altium 6 to current version
- Cadence Allegro
- DesignSpark
- Eagle Libraries
- KiCad
- Mentor Graphics BoardStation
- Mentor Graphics Design Architect
- Mentor Graphics Design Expedition 99 and 2000
- OrCAD 9.X PCB and Capture
- PADS PowerPCB 3, 3.5, 4.X, and 5.X

Supus modificărilor.

WAGO Kontakttechnik GmbH & Co. KG
 /Representative Office Romania
 Sos. Pipera-Tunari nr. 1/1
 building 1, 2nd floor | 077190 Voluntari, Ilfov
 Tel.: +40-(0)31 421 85 68 | Email: info-RO@wago.com

Aveți întrebări despre produsele noastre?

Vă stăm la dispoziție pentru preluarea apelului la +40 (0) 31 421 85 68.

- PADS PowerPCB and PowerLogic 3.0
- PCAD 2000, 2001, 2002, 2004, and 2006
- Pulsonix 8.5 or newer
- STL
- 3D STEP
- TARGET 3001!
- View Logic ViewDraw
- Quadcept
- Zuken CadStar 3 and 4
- Zuken CR-5000 and CR-8000

PCB Component Libraries (EDA), PCB CAD Library Ultra Librarian

Installation Notes

Coding

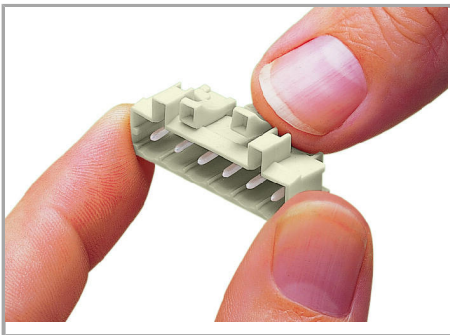

Coding a male header – fitting coding key(s).

Familie de produse

MCS MIDI

Afișare globală produse din familie.

Supus modificărilor.