

## Fișă tehnică | Număr articol: 282-126

2-conductor fuse terminal block; without blown fuse indication; for DIN-rail  
35 x 15 and 35 x 7.5; 6 mm<sup>2</sup>; CAGE CLAMP®; 6,00 mm<sup>2</sup>; gray

[www.wago.com/282-126](http://www.wago.com/282-126)

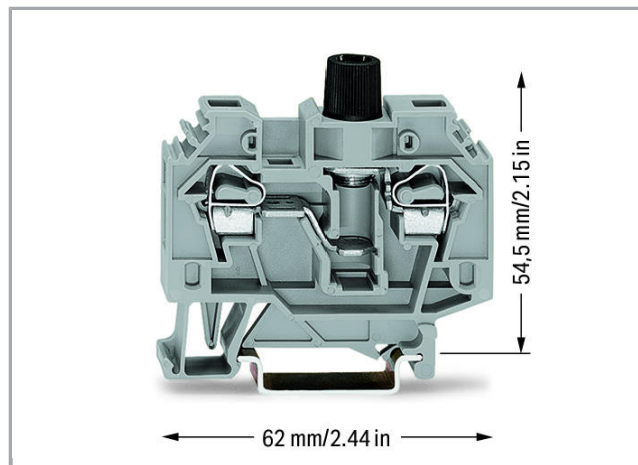
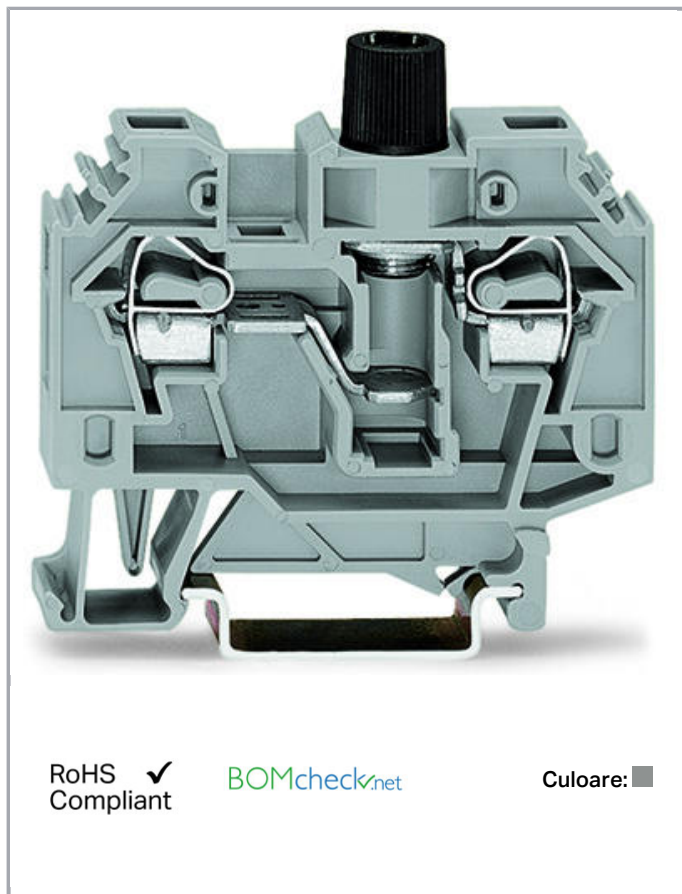

Supus modificărilor.

WAGO Kontakttechnik GmbH & Co. KG  
/Representative Office Romania  
Sos. Pipera-Tunari nr. 1/1  
building 1, 2nd floor | 077190 Voluntari, Ilfov  
Tel.: +40-(0)31 421 85 68 | Email: info-RO@wago.com

Aveți întrebări despre produsele noastre?  
Vă stăm la dispoziție pentru preluarea apelului la +40 (0) 31 421 85 68.

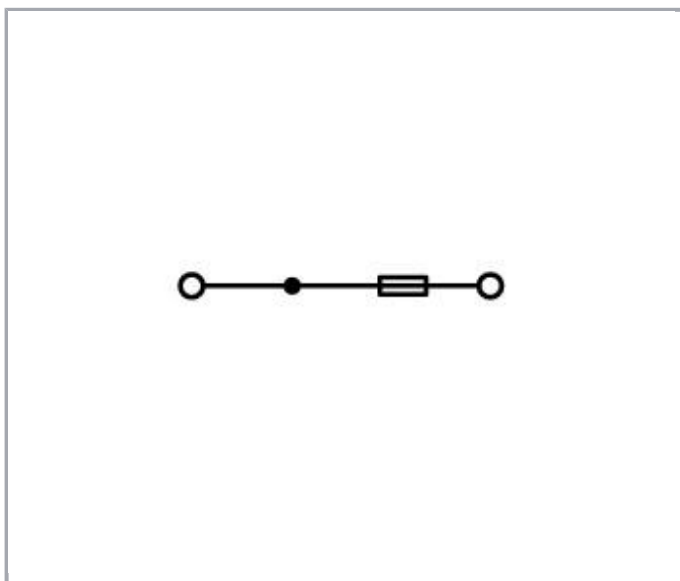
**Date****Electrical data****Ratings per IEC/EN 60664-1**

Nominal voltage (III/3)	500 V
Rated surge voltage (III/3)	6 kV
Rated current	10 A
Legend (ratings)	(III / 3) $\hat{=}$ Overvoltage category III / Pollution degree 3

**Connection data**

Connection technology	CAGE CLAMP®
Actuation type	Operating tool
Connectable conductor materials	Copper
Solid conductor	0,2 ... 6 mm <sup>2</sup> / 24 ... 10 AWG
Fine-stranded conductor	0,2 ... 6 mm <sup>2</sup> / 24 ... 10 AWG
Strip length	12 ... 13 mm / 0.47 ... 0.51 inch
Total number of connection points	2
Total number of potentials	2
Number of levels	1
Wiring type	Side-entry wiring

Supus modificărilor.

WAGO Kontakttechnik GmbH & Co. KG  
 /Representative Office Romania  
 Sos. Pipera-Tunari nr. 1/1  
 building 1, 2nd floor | 077190 Voluntari, Ilfov  
 Tel.: +40-(0)31 421 85 68 | Email: info-RO@wago.com

Aveți întrebări despre produsele noastre?  
 Vă stăm la dispoziție pentru preluarea apelului la +40 (0) 31 421 85 68.

## Geometrical Data

Width	13 mm / 0.512 inch
Height from upper-edge of DIN-rail	54,5 mm / 2.146 inch
Depth	62 mm / 2.441 inch

## Mechanical data

Design	horizontal type
Mounting type	DIN-35 rail
Marking level	Side marking

## Material Data



Color	gray
Fire load	0,429 MJ
Weight	26,4 g

## Commercial data

Product Group	1 (Rail Mounted Terminal Blocks)
Packaging type	BOX
Country of origin	CN
GTIN	4044918558518
Customs tariff number	85369095990

## Aprobări / certificate



### Country specific Approvals

Emblemă	Aprobare	Text de aprobare suplimentar	Nume certificat
	KEMA/KEUR DEKRA Certification B.V.	EN 60947	NTR NL-7135
	KEMA/KEUR DEKRA Certification B.V.	EN 60947	2160584.31

### Ship Approvals

Nume

Supus modificărilor.

Emblemă	Aprobare	Text de aprobare suplimentar	certificat
	<b>ABS</b> American Bureau of Shipping	EN 60947	20- HG1941090- PDA
	<b>DNV GL</b> Det Norske Veritas, Germanischer Lloyd	-	TAE00001V2





#### UL-Approvals

Emblemă	Aprobare	Text de aprobare suplimentar	Nume certificat
	<b>UR</b> Underwriters Laboratories Inc.	UL 1059	E45172

#### Counterpart

#### Produse compatibile









#### Carrier rail

	<b>Nr. articol: 210-112</b> Steel carrier rail; 35 x 7.5 mm; 1 mm thick; 2 m long; slotted; according to EN 60715; "Hole width 25 mm	<a href="http://www.wago.com/210-112">www.wago.com/210-112</a>
	<b>Nr. articol: 210-113</b> Steel carrier rail; 35 x 7.5 mm; 1 mm thick; 2 m long; unslotted; according to EN 60715	<a href="http://www.wago.com/210-113">www.wago.com/210-113</a>
	<b>Nr. articol: 210-114</b> Steel carrier rail; 35 x 15 mm; 1.5 mm thick; 2 m long; unslotted; similar to EN 60715	<a href="http://www.wago.com/210-114">www.wago.com/210-114</a>
	<b>Nr. articol: 210-115</b> Steel carrier rail; 35 x 7.5 mm; 1 mm thick; 2 m long; slotted; according to EN 60715; "Hole width 18 mm	<a href="http://www.wago.com/210-115">www.wago.com/210-115</a>







Supus modificărilor.

WAGO Kontakttechnik GmbH & Co. KG  
/Representative Office Romania  
Sos. Pipera-Tunari nr. 1/1  
building 1, 2nd floor | 077190 Voluntari, Ilfov  
Tel.: +40-(0)31 421 85 68 | Email: info-RO@wago.com

Aveți întrebări despre produsele noastre?  
Vă stăm la dispoziție pentru preluarea apelului la +40 (0) 31 421 85 68.

	<b>Nr. articol: 210-118</b> Steel carrier rail; 35 x 15 mm; 2.3 mm thick; 2 m long; unslotted; according to EN 60715	<a href="http://www.wago.com/210-118">www.wago.com/210-118</a>
	<b>Nr. articol: 210-196</b> Aluminum carrier rail; 35 x 8.2 mm; 1.6 mm thick; 2 m long; unslotted; similar to EN 60715; silver-colored	<a href="http://www.wago.com/210-196">www.wago.com/210-196</a>
	<b>Nr. articol: 210-197</b> Steel carrier rail; 35 x 15 mm; 1.5 mm thick; 2 m long; slotted; similar to EN 60715	<a href="http://www.wago.com/210-197">www.wago.com/210-197</a>
	<b>Nr. articol: 210-198</b> Copper carrier rail; 35 x 15 mm; 2.3 mm thick; 2 m long; unslotted; according to EN 60715; copper-colored	<a href="http://www.wago.com/210-198">www.wago.com/210-198</a>
	<b>Nr. articol: 210-504</b> Steel carrier rail; 35 x 7.5 mm; 1 mm thick; 2 m long; slotted; galvanized; according to EN 60715	<a href="http://www.wago.com/210-504">www.wago.com/210-504</a>
	<b>Nr. articol: 210-505</b> Steel carrier rail; 35 x 7.5 mm; 1 mm thick; 2 m long; unslotted; galvanized; according to EN 60715	<a href="http://www.wago.com/210-505">www.wago.com/210-505</a>
	<b>Nr. articol: 210-506</b> Steel carrier rail; 35 x 15 mm; 1.5 mm thick; 2 m long; unslotted; galvanized; similar to EN 60715	<a href="http://www.wago.com/210-506">www.wago.com/210-506</a>
	<b>Nr. articol: 210-508</b> Steel carrier rail; 35 x 15 mm; 1.5 mm thick; 2 m long; slotted; galvanized; similar to EN 60715	<a href="http://www.wago.com/210-508">www.wago.com/210-508</a>















**Marking accessories**

	<b>Nr. articol: 2009-115</b> WMB-Inline; for Smart Printer; 1500 pieces on roll; stretchable 5 - 5.2 mm; plain; snap-on type; white	<a href="http://www.wago.com/2009-115">www.wago.com/2009-115</a>
	<b>Nr. articol: 2009-115/000-002</b> WMB-Inline; for Smart Printer; 1500 pieces on roll; stretchable 5 - 5.2 mm; plain; snap-on type; yellow	<a href="http://www.wago.com/2009-115/000-002">www.wago.com/2009-115/000-002</a>
	<b>Nr. articol: 2009-115/000-006</b> WMB-Inline; for Smart Printer; 1500 pieces on roll; stretchable 5 - 5.2 mm; plain; snap-on type; blue	<a href="http://www.wago.com/2009-115/000-006">www.wago.com/2009-115/000-006</a>
	<b>Nr. articol: 2009-115/000-007</b> WMB-Inline; for Smart Printer; 1500 pieces on roll; stretchable 5 - 5.2 mm; plain; snap-on type; gray	<a href="http://www.wago.com/2009-115/000-007">www.wago.com/2009-115/000-007</a>
	<b>Nr. articol: 2009-115/000-012</b> WMB-Inline; for Smart Printer; 1500 pieces on roll; stretchable 5 - 5.2 mm; plain; snap-on type; orange	<a href="http://www.wago.com/2009-115/000-012">www.wago.com/2009-115/000-012</a>
	<b>Nr. articol: 2009-115/000-017</b> WMB-Inline; for Smart Printer; 1500 pieces on roll; stretchable 5 - 5.2 mm; plain; snap-on type; light green	<a href="http://www.wago.com/2009-115/000-017">www.wago.com/2009-115/000-017</a>
	<b>Nr. articol: 2009-115/000-023</b> WMB-Inline; for Smart Printer; 1500 pieces on roll; stretchable 5 - 5.2 mm; plain; snap-on type; green	<a href="http://www.wago.com/2009-115/000-023">www.wago.com/2009-115/000-023</a>

Supus modificărilor.

WAGO Kontakttechnik GmbH & Co. KG  
/Representative Office Romania  
Sos. Pipera-Tunari nr. 1/1  
building 1, 2nd floor | 077190 Voluntari, Ilfov  
Tel.: +40-(0)31 421 85 68 | Email: info-RO@wago.com

Aveți întrebări despre produsele noastre?  
Vă stăm la dispoziție pentru preluarea apelului la +40 (0) 31 421 85 68.

	<b>Nr. articol: 2009-115/000-024</b> WMB-Inline; for Smart Printer; 1500 pieces on roll; stretchable 5 - 5.2 mm; plain; snap-on type; violet	<a href="http://www.wago.com/2009-115/000-024">www.wago.com/2009-115/000-024</a>
	<b>Nr. articol: 249-105</b> Group marker carrier; gray	<a href="http://www.wago.com/249-105">www.wago.com/249-105</a>
	<b>Nr. articol: 793-501</b> WMB marking card; as card; not stretchable; plain; snap-on type; white	<a href="http://www.wago.com/793-501">www.wago.com/793-501</a>
	<b>Nr. articol: 793-501/000-002</b> WMB marking card; as card; not stretchable; plain; snap-on type; yellow	<a href="http://www.wago.com/793-501/000-002">www.wago.com/793-501/000-002</a>
	<b>Nr. articol: 793-501/000-005</b> WMB marking card; as card; not stretchable; plain; snap-on type; red	<a href="http://www.wago.com/793-501/000-005">www.wago.com/793-501/000-005</a>
	<b>Nr. articol: 793-501/000-006</b> WMB marking card; as card; not stretchable; plain; snap-on type; blue	<a href="http://www.wago.com/793-501/000-006">www.wago.com/793-501/000-006</a>
	<b>Nr. articol: 793-501/000-007</b> WMB marking card; as card; not stretchable; plain; snap-on type; gray	<a href="http://www.wago.com/793-501/000-007">www.wago.com/793-501/000-007</a>
	<b>Nr. articol: 793-501/000-012</b> WMB marking card; as card; not stretchable; plain; snap-on type; orange	<a href="http://www.wago.com/793-501/000-012">www.wago.com/793-501/000-012</a>
	<b>Nr. articol: 793-501/000-017</b> WMB marking card; as card; not stretchable; plain; snap-on type; light green	<a href="http://www.wago.com/793-501/000-017">www.wago.com/793-501/000-017</a>
	<b>Nr. articol: 793-501/000-023</b> WMB marking card; as card; not stretchable; plain; snap-on type; green	<a href="http://www.wago.com/793-501/000-023">www.wago.com/793-501/000-023</a>
	<b>Nr. articol: 793-501/000-024</b> WMB marking card; as card; not stretchable; plain; snap-on type; violet	<a href="http://www.wago.com/793-501/000-024">www.wago.com/793-501/000-024</a>
	<b>Nr. articol: 793-5501</b> WMB marking card; as card; for terminal block width 5 - 17.5 mm; stretchable 5 - 5.2 mm; plain; snap-on type; white	<a href="http://www.wago.com/793-5501">www.wago.com/793-5501</a>
	<b>Nr. articol: 793-5501/000-002</b> WMB marking card; as card; for terminal block width 5 - 17.5 mm; stretchable 5 - 5.2 mm; plain; snap-on type; yellow	<a href="http://www.wago.com/793-5501/000-002">www.wago.com/793-5501/000-002</a>
	<b>Nr. articol: 793-5501/000-005</b> WMB marking card; as card; for terminal block width 5 - 17.5 mm; stretchable 5 - 5.2 mm; plain; snap-on type; red	<a href="http://www.wago.com/793-5501/000-005">www.wago.com/793-5501/000-005</a>

Supus modificărilor.

**Nr. articol:** 793-5501/000-006

WMB marking card; as card; for terminal block width 5 - 17.5 mm; stretchable 5 - 5.2 mm; plain; snap-on type; blue

[www.wago.com/793-5501/000-006](http://www.wago.com/793-5501/000-006)**Nr. articol:** 793-5501/000-007

WMB marking card; as card; for terminal block width 5 - 17.5 mm; stretchable 5 - 5.2 mm; plain; snap-on type; gray

[www.wago.com/793-5501/000-007](http://www.wago.com/793-5501/000-007)**Nr. articol:** 793-5501/000-012

WMB marking card; as card; for terminal block width 5 - 17.5 mm; stretchable 5 - 5.2 mm; plain; snap-on type; orange

[www.wago.com/793-5501/000-012](http://www.wago.com/793-5501/000-012)**Nr. articol:** 793-5501/000-014

WMB marking card; as card; for terminal block width 5 - 17.5 mm; stretchable 5 - 5.2 mm; plain; snap-on type; brown

[www.wago.com/793-5501/000-014](http://www.wago.com/793-5501/000-014)**Nr. articol:** 793-5501/000-017

WMB marking card; as card; for terminal block width 5 - 17.5 mm; stretchable 5 - 5.2 mm; plain; snap-on type; green

[www.wago.com/793-5501/000-017](http://www.wago.com/793-5501/000-017)**Nr. articol:** 793-5501/000-023

WMB marking card; as card; for terminal block width 5 - 17.5 mm; stretchable 5 - 5.2 mm; plain; snap-on type; light green

[www.wago.com/793-5501/000-023](http://www.wago.com/793-5501/000-023)**Nr. articol:** 793-5501/000-024

WMB marking card; as card; for terminal block width 5 - 17.5 mm; stretchable 5 - 5.2 mm; plain; snap-on type; violet

[www.wago.com/793-5501/000-024](http://www.wago.com/793-5501/000-024)**tools****Nr. articol:** 210-721

Operating tool; Blade: 5.5 x 0.8 mm; with a partially insulated shaft

[www.wago.com/210-721](http://www.wago.com/210-721)**Protective Warning Marker****Nr. articol:** 282-405

Protective warning marker; with high-voltage symbol, black; for 5 terminal blocks; yellow

[www.wago.com/282-405](http://www.wago.com/282-405)**End plate****Nr. articol:** 282-311

End and intermediate plate; 4 mm thick; gray

[www.wago.com/282-311](http://www.wago.com/282-311)**Nr. articol:** 282-312

End and intermediate plate; 4 mm thick; orange

[www.wago.com/282-312](http://www.wago.com/282-312)**check****Nr. articol:** 209-170Test plug adapter; 8.3 mm wide; for 4 mm Ø test plugs; suitable for 1.5 mm<sup>2</sup> - 10 mm<sup>2</sup> tbs; gray[www.wago.com/209-170](http://www.wago.com/209-170)**Jumper****Nr. articol:** 210-103



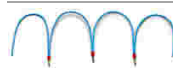













Wire commoning chain; insulated; 50 connections; black

[www.wago.com/210-103](http://www.wago.com/210-103)**Nr. articol:** 210-123

Wire commoning chain; insulated; 50 connections



[www.wago.com/210-123](http://www.wago.com/210-123)

Supus modificărilor.

	<b>Nr. articol: 282-402</b> Adjacent jumper; insulated; Nominal current 41 A	<a href="http://www.wago.com/282-402">www.wago.com/282-402</a>
	<b>Nr. articol: 282-409</b> Alternate jumper; insulated; Nominal current 41 A; gray	<a href="http://www.wago.com/282-409">www.wago.com/282-409</a>
	<b>Nr. articol: 282-422</b> Adjacent jumper; insulated; Nominal current 41 A; yellow-green	<a href="http://www.wago.com/282-422">www.wago.com/282-422</a>
	<b>Nr. articol: 282-424</b> Adjacent jumper; insulated; Nominal current 41 A; orange	<a href="http://www.wago.com/282-424">www.wago.com/282-424</a>
	<b>Nr. articol: 709-110</b> Wire commoning chain; insulated; 4 connections; 3 x 110 mm; black	<a href="http://www.wago.com/709-110">www.wago.com/709-110</a>
	<b>Nr. articol: 709-111</b> Wire commoning chain; insulated; 3 connections; 2 x 120 mm; black	<a href="http://www.wago.com/709-111">www.wago.com/709-111</a>
	<b>Nr. articol: 709-112</b> Wire commoning chain; insulated; 3 connections; 2 x 170 mm; black	<a href="http://www.wago.com/709-112">www.wago.com/709-112</a>
<b>General accessories</b>		
	<b>Nr. articol: 209-143</b> Group marker carrier; gray	<a href="http://www.wago.com/209-143">www.wago.com/209-143</a>
	<b>Nr. articol: 209-144</b> Group marker carrier; gray	<a href="http://www.wago.com/209-144">www.wago.com/209-144</a>
	<b>Nr. articol: 281-407</b> Test plug; 6 mm wide; Nominal current 24 A; for 0.08 mm <sup>2</sup> - 2.5 mm <sup>2</sup> ; 2,50 mm <sup>2</sup> ; gray	<a href="http://www.wago.com/281-407">www.wago.com/281-407</a>
	<b>Nr. articol: 282-452</b> Miniature metric fuse; with indicator; 5 x 25 mm; medium-slow	<a href="http://www.wago.com/282-452">www.wago.com/282-452</a>
	<b>Nr. articol: 282-453</b> Miniature metric fuse; with indicator; 5 x 25 mm; quick acting	<a href="http://www.wago.com/282-453">www.wago.com/282-453</a>
<b>assembling</b>		
	<b>Nr. articol: 209-106</b> Mounting carrier; for isolated mounting on DIN 35 rails; gray	<a href="http://www.wago.com/209-106">www.wago.com/209-106</a>
	<b>Nr. articol: 709-153</b> Cover; Type 1; suitable for cover carrier, type 1; 1 m long; transparent	<a href="http://www.wago.com/709-153">www.wago.com/709-153</a>
<b>ferrule</b>		
	<b>Nr. articol: 216-262</b> Ferrule; Sleeve for 0.75 mm <sup>2</sup> / 18 AWG; insulated; electro-tin plated; electrolytic copper; gastight crimped; acc. to DIN 46228, Part 4/09.90; gray	<a href="http://www.wago.com/216-262">www.wago.com/216-262</a>
	<b>Nr. articol: 216-263</b> Ferrule; Sleeve for 1 mm <sup>2</sup> / AWG 18; insulated; electro-tin plated; electrolytic copper; gastight crimped; acc. to DIN 46228, Part 4/09.90; red	<a href="http://www.wago.com/216-263">www.wago.com/216-263</a>
	<b>Nr. articol: 216-264</b>	

Supus modificărilor.



	Ferrule; Sleeve for 1.5 mm <sup>2</sup> / AWG 16; insulated; electro-tin plated; electrolytic copper; gastight crimped; acc. to DIN 46228, Part 4/09.90; black	<a href="http://www.wago.com/216-264">www.wago.com/216-264</a>
	<b>Nr. articol: 216-266</b> Ferrule; Sleeve for 2.5 mm <sup>2</sup> / AWG 14; insulated; electro-tin plated; electrolytic copper; gastight crimped; acc. to DIN 46228, Part 4/09.90; blue	<a href="http://www.wago.com/216-266">www.wago.com/216-266</a>
	<b>Nr. articol: 216-267</b> Ferrule; Sleeve for 4 mm <sup>2</sup> / AWG 12; insulated; electro-tin plated; electrolytic copper; gastight crimped; acc. to DIN 46228, Part 4/09.90; gray	<a href="http://www.wago.com/216-267">www.wago.com/216-267</a>

## Descărcări

### Documentation

#### Additional Information

Technical explanations	Apr 3, 2019	pdf 2,1 MB	Descărcare
------------------------	-------------	---------------	------------

## CAD/CAE-Data

### CAD data

2D/3D Models 282-126	URL	Descărcare
----------------------	-----	------------

### CAE data

EPLAN Data Portal 282-126	URL	Descărcare
WSCAD Universe 282-126	URL	Descărcare

## Installation Notes

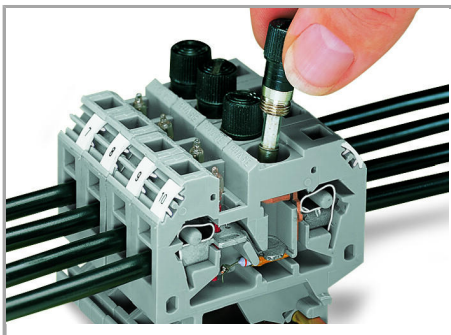

Replacing a fuse.

Supus modificărilor.

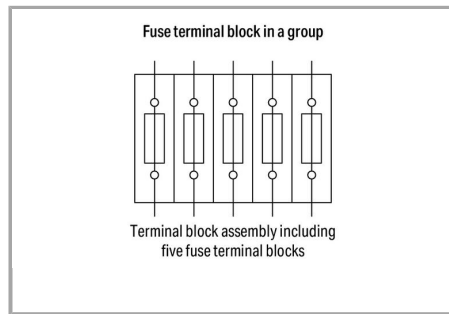
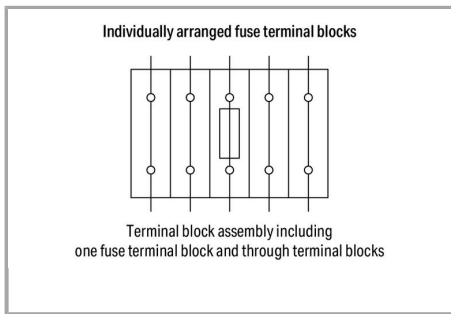

Individually arranged fuse terminal blocks

Fuse terminal blocks in a group

Supus modificărilor.