

Fișă tehnică | Număr articol: 2000-2202

Double-deck terminal block; Through/through terminal block; N/L; without marker carrier; Blue conductor entry lower deck; for DIN-rail 35 x 15 and 35 x 7.5; 1 mm²; Push-in CAGE CLAMP®; 1,00 mm²; gray

www.wago.com/2000-2202

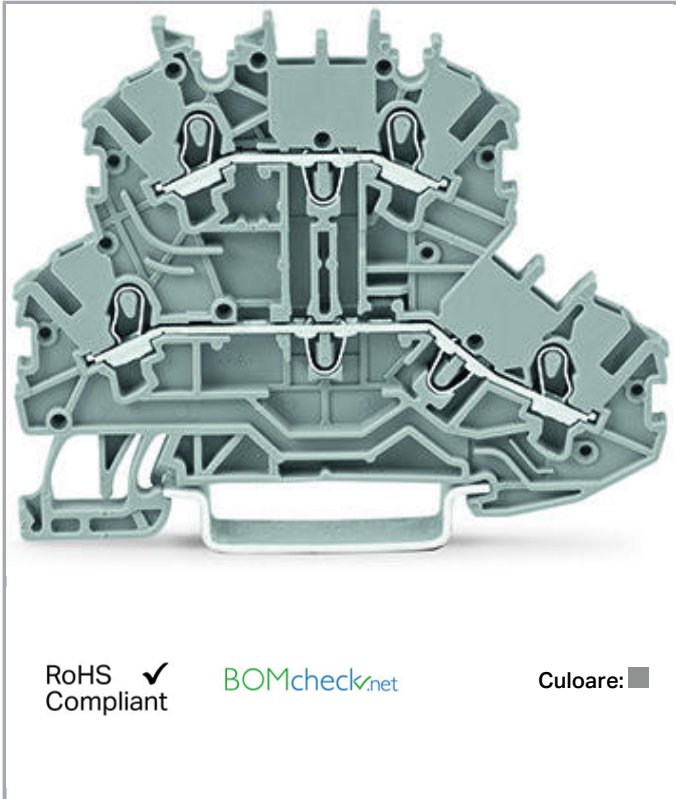

RoHS Compliant

[BOMcheck.net](https://www.bomcheck.net)

Culoare: ■

Date

Electrical data

Ratings per IEC/EN 60664-1

Ratings per	IEC/EN 60947-7-1
Nominal voltage (III/3)	500 V
Rated surge voltage (III/3)	6 kV
Rated current	13,5 A
Rated current 2	16 A
Legend (ratings)	(III / 3) ≙ Overvoltage category III / Pollution degree 3

Approvals per UL 1059

Rated voltage UL (Use Group B)	300 V
--------------------------------	-------

Supus modificărilor.

WAGO Kontakttechnik GmbH & Co. KG
/Representative Office Romania
Sos. Pipera-Tunari nr. 1/1
building 1, 2nd floor | 077190 Voluntari, Ilfov
Tel.: +40-(0)31 421 85 68 | Email: info-RO@wago.com

Aveți întrebări despre produsele noastre?
Vă stăm la dispoziție pentru preluarea apelului la +40 (0) 31 421 85 68.



Rated current UL (Use Group B)	15 A
Rated voltage UL (Use Group C)	300 V
Rated current UL (Use Group C)	15 A
Approvals per	UL 1059

Approvals per CSA

Rated voltage CSA (Use Group B)	600 V
Rated current CSA (Use Group B)	10 A
Rated voltage CSA (Use Group C)	600 V
Rated current CSA (Use Group C)	10 A

Connection data

Connection technology	Push-in CAGE CLAMP®
Number of connection points (connection type)	2
Actuation type	Push-in Open Tool Slot
Connectable conductor materials	Copper
Nominal cross-section	1 mm ²
Solid conductor	0,14 ... 1,5 mm ² / 24 ... 16 AWG
Solid conductor; push-in termination	0,5 ... 1,5 mm ² / 20 ... 16 AWG
Fine-stranded conductor	0,14 ... 1,5 mm ² / 24 ... 16 AWG
Fine-stranded conductor; with insulated ferrule	0,5 ... 0,75 mm ² / 20 ... 18 AWG
Fine-stranded conductor; with ferrule; push-in termination	0,5 ... 0,75 mm ² / 20 ... 18 AWG
Strip length	9 ... 11 mm / 0.35 ... 0.43 inch
Number of connection points	2
Total number of connection points	4
Total number of potentials	2
Number of levels	2
Wiring type	Front-entry wiring
Note (conductor cross-section)	Depending on the conductor characteristic, a conductor with a smaller cross-section can also be inserted via push-in termination.

Geometrical Data

Width	3,5 mm / 0.138 inch
Height from upper-edge of DIN-rail	51,7 mm / 2.035 inch
Depth	69,7 mm / 2.744 inch

Supus modificărilor.

WAGO Kontakttechnik GmbH & Co. KG
/Representative Office Romania
Sos. Pipera-Tunari nr. 1/1
building 1, 2nd floor | 077190 Voluntari, Ilfov
Tel.: +40-(0)31 421 85 68 | Email: info-RO@wago.com

Aveți întrebări despre produsele noastre?
Vă stăm la dispoziție pentru preluarea apelului la +40 (0) 31 421 85 68.

Mechanical data

Design	horizontal type
Mounting type	DIN-35 rail
Potential marking	N/L
Marking level	Center/side marking

Material Data

Color	gray
Insulation material	Polyamide 66 (PA 66)
Fire load	0,152 MJ
Weight	7,3 g

Commercial data

Product Group	22 (TOPJOB S)
Packaging type	BOX
Country of origin	CN
GTIN	4055143267731
Customs tariff number	85369010000

Aprobări / certificate

Ex-Approvals



Emblemă	Aprobare	Text de aprobare suplimentar	Nume certificat
	AEx Underwriters Laboratories Inc.	UL 60079	E185892
	ATEX Physikalisch Technische Bundesanstalt	EN 60079	PTB 11 ATEX 1041 U (II 2 G Ex e IIC GB / I M 2 Ex e I Mb)

Country specific Approvals

Emblemă	Aprobare	Text de aprobare suplimentar	Nume certificat
	CCA DEKRA Certification B.V.	EN 60947	71- 102841

Supus modificărilor.









	CCA DEKRA Certification B.V.	EN 60947	NTR NL 7671
	CSA DEKRA Certification B.V.	C22.2 No. 158	2130762

Counterpart

Produse compatibile

















check

	Nr. articol: 2000-510 TOPJOB®S L-type test plug module; modular; for jumper contact slot; 1,00 mm ² ; gray	www.wago.com/2000-510
	Nr. articol: 2000-511 TOPJOB®S L-type test plug module; modular; for jumper contact slot; 1-pole; 1,00 mm ² ; gray	www.wago.com/2000-511
	Nr. articol: 2000-549 Spacer module; modular; e.g., for bridging commoned terminal blocks; gray	www.wago.com/2000-549
	Nr. articol: 2000-552 Modular TOPJOB®S connector; modular; for jumper contact slot; 2-pole; 1,00 mm ² ; gray	www.wago.com/2000-552
	Nr. articol: 2000-553 Modular TOPJOB®S connector; modular; for jumper contact slot; 3-pole; 1,00 mm ² ; gray	www.wago.com/2000-553
	Nr. articol: 2000-554 Modular TOPJOB®S connector; modular; for jumper contact slot; 4-pole; 1,00 mm ² ; gray	www.wago.com/2000-554
	Nr. articol: 2000-555 Modular TOPJOB®S connector; modular; for jumper contact slot; 5-pole; 1,00 mm ² ; gray	www.wago.com/2000-555















Supus modificărilor.

WAGO Kontakttechnik GmbH & Co. KG
/Representative Office Romania
Sos. Pipera-Tunari nr. 1/1
building 1, 2nd floor | 077190 Voluntari, Ilfov
Tel.: +40-(0)31 421 85 68 | Email: info-RO@wago.com















Aveți întrebări despre produsele noastre?
Vă stăm la dispoziție pentru preluarea apelului la +40 (0) 31 421 85 68.

	Nr. articol: 2000-556 Modular TOPJOB®S connector; modular; for jumper contact slot; 6-pole; 1,00 mm ² ; gray	www.wago.com/2000-556
	Nr. articol: 2000-557 Modular TOPJOB®S connector; modular; for jumper contact slot; 7-pole; 1,00 mm ² ; gray	www.wago.com/2000-557
	Nr. articol: 2000-558 Modular TOPJOB®S connector; modular; for jumper contact slot; 8-pole; 1,00 mm ² ; gray	www.wago.com/2000-558
	Nr. articol: 2000-559 Modular TOPJOB®S connector; modular; for jumper contact slot; 9-pole; 1,00 mm ² ; gray	www.wago.com/2000-559
	Nr. articol: 2000-560 Modular TOPJOB®S connector; modular; for jumper contact slot; 10-pole; 1,00 mm ² ; gray	www.wago.com/2000-560
	Nr. articol: 2009-174 Test plug adapter; for 4 mm Ø test plugs; for testing TOPJOB®S rail-mounted terminal blocks; gray	www.wago.com/2009-174
	Nr. articol: 2009-182 Testing tap; for max. 2.5 mm ² ; tool-free connection for individual test wires 0.08 - 2.5 mm; gray	www.wago.com/2009-182
	Nr. articol: 210-136 Test plug; 2 mm Ø; with 500 mm cable; red	www.wago.com/210-136
	Nr. articol: 210-137 Test plug; 2.3 mm Ø; with 500 mm cable; yellow	www.wago.com/210-137
Protective Warning Marker		
	Nr. articol: 2000-115 Protective warning marker; with high-voltage symbol, black; for 5 terminal blocks; yellow	www.wago.com/2000-115
Marking accessories		
	Nr. articol: 2000-121 Adaptor	www.wago.com/2000-121
	Nr. articol: 2009-110 Marking strips; on reel; not stretchable; plain; snap-on type; white	www.wago.com/2009-110
	Nr. articol: 2009-113 WMB-Inline; for Smart Printer; 2300 pieces on roll; plain; snap-on type; white	www.wago.com/2009-113
	Nr. articol: 2009-113/000-002 WMB-Inline; for Smart Printer; 2300 pieces on roll; plain; snap-on type; yellow	www.wago.com/2009-113/000-002
	Nr. articol: 2009-113/000-005 WMB-Inline; for Smart Printer; 2300 pieces on roll; plain; snap-on type; red	www.wago.com/2009-113/000-005
	Nr. articol: 2009-113/000-006 WMB-Inline; for Smart Printer; 2300 pieces on roll; plain; snap-on type; blue	www.wago.com/2009-113/000-006

















Supus modificărilor.

	Nr. articol: 2009-113/000-007 WMB-Inline; for Smart Printer; 2300 pieces on roll; plain; snap-on type; gray	www.wago.com/2009-113/000-007
	Nr. articol: 2009-113/000-012 WMB-Inline; for Smart Printer; 2300 pieces on roll; plain; snap-on type; orange	www.wago.com/2009-113/000-012
	Nr. articol: 2009-113/000-017 WMB-Inline; for Smart Printer; 2300 pieces on roll; plain; snap-on type; light green	www.wago.com/2009-113/000-017
	Nr. articol: 2009-113/000-023 WMB-Inline; for Smart Printer; 2300 pieces on roll; plain; snap-on type; green	www.wago.com/2009-113/000-023
	Nr. articol: 2009-113/000-024 WMB-Inline; for Smart Printer; 2300 pieces on roll; plain; snap-on type; violet	www.wago.com/2009-113/000-024
	Nr. articol: 793-3501 WMB marking card; as card; plain; snap-on type; white	www.wago.com/793-3501
Jumper		
	Nr. articol: 2000-402 Push-in type jumper bar; insulated; 2-way; Nominal current 14 A; light gray	www.wago.com/2000-402
	Nr. articol: 2000-402/000-005 Push-in type jumper bar; insulated; 2-way; Nominal current 14 A; red	www.wago.com/2000-402/000-005
	Nr. articol: 2000-402/000-006 Push-in type jumper bar; insulated; 2-way; Nominal current 14 A; blue	www.wago.com/2000-402/000-006
	Nr. articol: 2000-402/000-018 Push-in type jumper bar; insulated; 2-way; Nominal current 14 A; yellow-green	www.wago.com/2000-402/000-018
	Nr. articol: 2000-403 Push-in type jumper bar; insulated; 3-way; Nominal current 14 A; light gray	www.wago.com/2000-403
	Nr. articol: 2000-403/000-005 Push-in type jumper bar; insulated; 3-way; Nominal current 14 A; red	www.wago.com/2000-403/000-005
	Nr. articol: 2000-403/000-006 Push-in type jumper bar; insulated; 3-way; Nominal current 14 A; blue	www.wago.com/2000-403/000-006
	Nr. articol: 2000-404 Push-in type jumper bar; insulated; 4-way; Nominal current 14 A; light gray	www.wago.com/2000-404

















Supus modificărilor.

	Nr. articol: 2000-404/000-005 Push-in type jumper bar; insulated; 4-way; Nominal current 14 A; red	www.wago.com/2000-404/000-005
	Nr. articol: 2000-404/000-006 Push-in type jumper bar; insulated; 4-way; Nominal current 14 A; blue	www.wago.com/2000-404/000-006
	Nr. articol: 2000-405 Push-in type jumper bar; insulated; 5-way; Nominal current 14 A; light gray	www.wago.com/2000-405
	Nr. articol: 2000-405/000-005 Push-in type jumper bar; insulated; 5-way; Nominal current 14 A; red	www.wago.com/2000-405/000-005
	Nr. articol: 2000-405/000-006 Push-in type jumper bar; insulated; 5-way; Nominal current 14 A; blue	www.wago.com/2000-405/000-006
	Nr. articol: 2000-405/011-000 Star point jumper; insulated; 3-way (1-3-5); IN = IN terminal block; light gray	www.wago.com/2000-405/011-000
	Nr. articol: 2000-406 Push-in type jumper bar; insulated; 6-way; Nominal current 14 A; light gray	www.wago.com/2000-406
	Nr. articol: 2000-406/000-005 Push-in type jumper bar; insulated; 6-way; Nominal current 14 A; red	www.wago.com/2000-406/000-005
	Nr. articol: 2000-406/000-006 Push-in type jumper bar; insulated; 6-way; Nominal current 14 A; blue	www.wago.com/2000-406/000-006
	Nr. articol: 2000-406/020-000 Delta jumper; insulated; 1-2 3-4 5-6; IN = IN terminal block; light gray	www.wago.com/2000-406/020-000
	Nr. articol: 2000-407 Push-in type jumper bar; insulated; 7-way; Nominal current 14 A; light gray	www.wago.com/2000-407
	Nr. articol: 2000-407/000-005 Push-in type jumper bar; insulated; 7-way; Nominal current 14 A; red	www.wago.com/2000-407/000-005
	Nr. articol: 2000-407/000-006 Push-in type jumper bar; insulated; 7-way; Nominal current 14 A; blue	www.wago.com/2000-407/000-006
	Nr. articol: 2000-408 Push-in type jumper bar; insulated; 8-way; Nominal current 14 A; light gray	www.wago.com/2000-408
	Nr. articol: 2000-408/000-005 Push-in type jumper bar; insulated; 8-way; Nominal current 14 A; red	www.wago.com/2000-408/000-005

Supus modificărilor.

		
	Nr. articol: 2000-408/000-006 Push-in type jumper bar; insulated; 8-way; Nominal current 14 A; blue	www.wago.com/2000-408/000-006
	Nr. articol: 2000-409 Push-in type jumper bar; insulated; 9-way; Nominal current 14 A; light gray	www.wago.com/2000-409
	Nr. articol: 2000-409/000-005 Push-in type jumper bar; insulated; 9-way; Nominal current 14 A; red	www.wago.com/2000-409/000-005
	Nr. articol: 2000-409/000-006 Push-in type jumper bar; insulated; 9-way; Nominal current 14 A; blue	www.wago.com/2000-409/000-006
	Nr. articol: 2000-410 Push-in type jumper bar; insulated; 10-way; Nominal current 14 A; light gray	www.wago.com/2000-410
	Nr. articol: 2000-410/000-005 Push-in type jumper bar; insulated; 10-way; Nominal current 14 A; red	www.wago.com/2000-410/000-005
	Nr. articol: 2000-410/000-006 Push-in type jumper bar; insulated; 10-way; Nominal current 14 A; blue	www.wago.com/2000-410/000-006
	Nr. articol: 2000-433 Push-in type jumper bar; insulated; from 1 to 3; Nominal current 14 A; light gray	www.wago.com/2000-433
	Nr. articol: 2000-433/000-005 Push-in type jumper bar; insulated; from 1 to 3; Nominal current 14 A; red	www.wago.com/2000-433/000-005
	Nr. articol: 2000-433/000-006 Push-in type jumper bar; insulated; from 1 to 3; Nominal current 14 A; blue	www.wago.com/2000-433/000-006
	Nr. articol: 2000-434 Push-in type jumper bar; insulated; from 1 to 4; Nominal current 14 A; light gray	www.wago.com/2000-434
	Nr. articol: 2000-435 Push-in type jumper bar; insulated; from 1 to 5; Nominal current 14 A; light gray	www.wago.com/2000-435
	Nr. articol: 2000-436 Push-in type jumper bar; insulated; from 1 to 6; Nominal current 14 A; light gray	www.wago.com/2000-436
	Nr. articol: 2000-437 Push-in type jumper bar; insulated; from 1 to 7; Nominal current 14 A; light gray	www.wago.com/2000-437
	Nr. articol: 2000-438 Push-in type jumper bar; insulated; from 1 to 8; Nominal current 14 A; light gray	www.wago.com/2000-438









Supus modificărilor.

	Nr. articol: 2000-439 Push-in type jumper bar; insulated; from 1 to 9; Nominal current 14 A; light gray	www.wago.com/2000-439
	Nr. articol: 2000-440 Push-in type jumper bar; insulated; from 1 to 10; Nominal current 14 A; light gray	www.wago.com/2000-440
	Nr. articol: 2000-492 Double-deck vertical jumper; insulated; light gray	www.wago.com/2000-492
	Nr. articol: 210-103 Wire commoning chain; insulated; 50 connections; black	www.wago.com/210-103
	Nr. articol: 210-123 Wire commoning chain; insulated; 50 connections	www.wago.com/210-123
tools		
	Nr. articol: 210-647 Operating tool; Blade: 2.5 x 0.4 mm; with a partially insulated shaft	www.wago.com/210-647
	Nr. articol: 210-648 Operating tool; Blade: 2.5 x 0.4 mm; with a partially insulated shaft; angled; short	www.wago.com/210-648
	Nr. articol: 210-719 Operating tool; Blade: 2.5 x 0.4 mm; with a partially insulated shaft	www.wago.com/210-719
Carrier rail		
	Nr. articol: 210-112 Steel carrier rail; 35 x 7.5 mm; 1 mm thick; 2 m long; slotted; according to EN 60715; "Hole width 25 mm	www.wago.com/210-112
	Nr. articol: 210-113 Steel carrier rail; 35 x 7.5 mm; 1 mm thick; 2 m long; unslotted; according to EN 60715	www.wago.com/210-113
	Nr. articol: 210-114 Steel carrier rail; 35 x 15 mm; 1.5 mm thick; 2 m long; unslotted; similar to EN 60715	www.wago.com/210-114
	Nr. articol: 210-115 Steel carrier rail; 35 x 7.5 mm; 1 mm thick; 2 m long; slotted; according to EN 60715; "Hole width 18 mm	www.wago.com/210-115
	Nr. articol: 210-118 Steel carrier rail; 35 x 15 mm; 2.3 mm thick; 2 m long; unslotted; according to EN 60715	www.wago.com/210-118
	Nr. articol: 210-196 Aluminum carrier rail; 35 x 8.2 mm; 1.6 mm thick; 2 m long; unslotted; similar to EN 60715; silver-colored	www.wago.com/210-196
	Nr. articol: 210-197 Steel carrier rail; 35 x 15 mm; 1.5 mm thick; 2 m long; slotted; similar to EN 60715	www.wago.com/210-197
	Nr. articol: 210-198 Copper carrier rail; 35 x 15 mm; 2.3 mm thick; 2 m long; unslotted; according to EN 60715; copper-colored	www.wago.com/210-198
Push-In type wire jumper		

Supus modificărilor.

WAGO Kontakttechnik GmbH & Co. KG
/Representative Office Romania
Sos. Pipera-Tunari nr. 1/1
building 1, 2nd floor | 077190 Voluntari, Ilfov
Tel.: +40-(0)31 421 85 68 | Email: info-RO@wago.com

Aveți întrebări despre produsele noastre?
Vă stăm la dispoziție pentru preluarea apelului la +40 (0) 31 421 85 68.

	Nr. articol: 2009-402 Push-in type wire jumper; insulated; wire length 60 mm; Conductor cross section 0.75 mm ² ; suitable for 2000 and 2020 Series rail-mounted terminal blocks; gray	www.wago.com/2009-402
	Nr. articol: 2009-404 Push-in type wire jumper; insulated; wire length 110 mm; Conductor cross section 0.75 mm ² ; suitable for 2000 and 2020 Series rail-mounted terminal blocks; gray	www.wago.com/2009-404
	Nr. articol: 2009-406 Push-in type wire jumper; insulated; wire length 250 mm; Conductor cross section 0.75 mm ² ; suitable for 2000 and 2020 Series rail-mounted terminal blocks; gray	www.wago.com/2009-406
ferrule		
	Nr. articol: 216-241 Ferrule; Sleeve for 0.5 mm ² / 20 AWG; insulated; electro-tin plated; electrolytic copper; gastight crimped; acc. to DIN 46228, Part 4/09.90; white	www.wago.com/216-241
	Nr. articol: 216-242 Ferrule; Sleeve for 0.75 mm ² / 18 AWG; insulated; electro-tin plated; electrolytic copper; gastight crimped; acc. to DIN 46228, Part 4/09.90; gray	www.wago.com/216-242
	Nr. articol: 216-243 Ferrule; Sleeve for 1 mm ² / AWG 18; insulated; electro-tin plated; electrolytic copper; gastight crimped; acc. to DIN 46228, Part 4/09.90; red	www.wago.com/216-243
End plate		
	Nr. articol: 2000-2291 End and intermediate plate; 0.7 mm thick; gray	www.wago.com/2000-2291
	Nr. articol: 2000-2292 End and intermediate plate; 0.7 mm thick; orange	www.wago.com/2000-2292

Descărcări Documentation

Additional Information

Technical explanations	Apr 3, 2019	pdf 2,1 MB	Descărcare
------------------------	-------------	---------------	------------

CAD/CAE-Data

CAD data

2D/3D Models 2000-2202	URL	Descărcare
------------------------	-----	------------

CAE data

EPLAN Data Portal 2000-2202	URL	Descărcare
-----------------------------	-----	------------

WSCAD Universe 2000-2202

Supus modificărilor.

WAGO Kontakttechnik GmbH & Co. KG
/Representative Office Romania
Sos. Pipera-Tunari nr. 1/1
building 1, 2nd floor | 077190 Voluntari, Ilfov
Tel.: +40-(0)31 421 85 68 | Email: info-RO@wago.com

Aveți întrebări despre produsele noastre?
Vă stăm la dispoziție pentru preluarea apelului la +40 (0) 31 421 85 68.

Installation Notes

Conductor termination

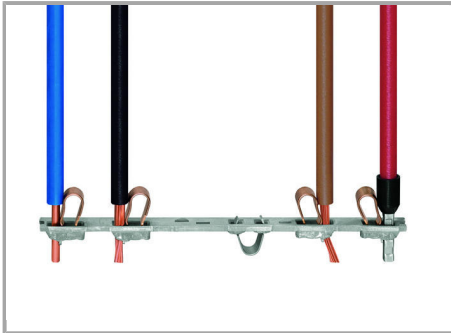

All conductor types at a glance

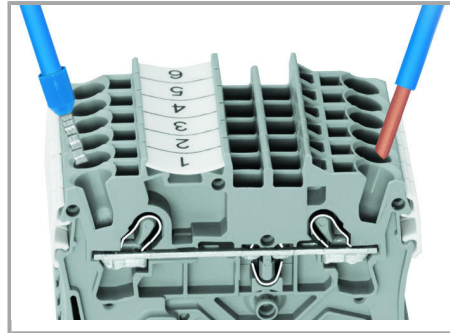

Terminating solid and ferruled conductors via push-in connection.

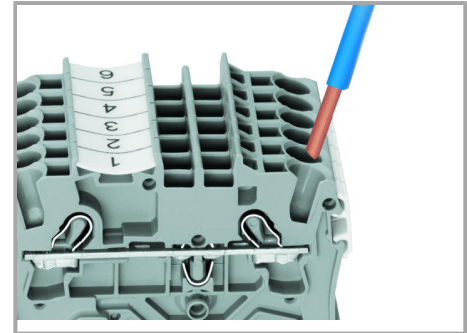

Inserting conductors via push-in termination.

Solid conductors with cross-sections from either one size above, or up to two sizes below, the rated cross-section can be simply pushed in – no tools needed.

Supus modificărilor.



Inserting a conductor via operating tool.

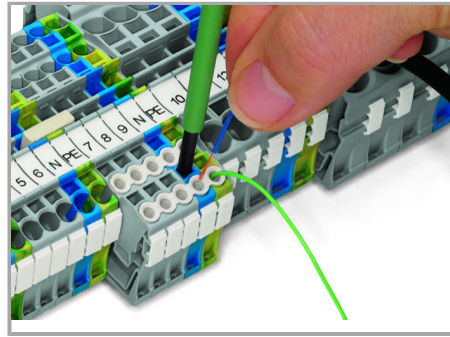

Conductor termination – Insulation stop.

Connecting fine-stranded conductors without ferrules, or small cross-sectional conductors that cannot be pushed in, is performed similarly to the original CAGE CLAMP® – just use an operating tool.

The smart feature:

To open the clamp, the operating tool is inserted vertically. The conductor entry is less than 15 degrees for easier wiring.

Marking

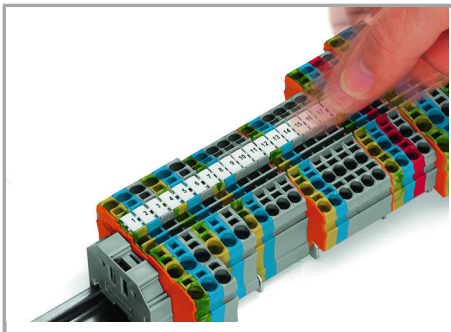

Snapping WMB Inline markers into marker slots.

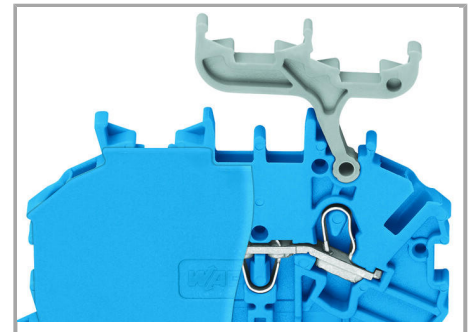
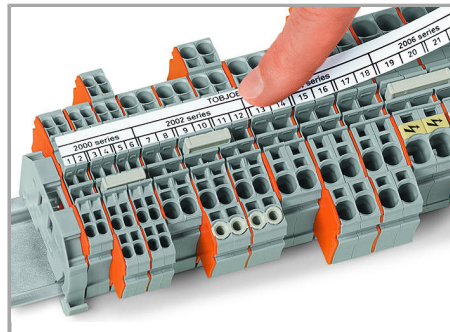

Double-Deck Terminal Blocks

A double-deck marker carrier (2000-121) can be retrofitted to double-deck terminal blocks without a marker carrier.

Supus modificărilor.



Familie de produse

TOPJOB® S

TOPJOB® S: In various industrial applications and modern building installations, WAGO's wide and versatile range of rail-mount terminal blocks provides more than just reliable electrical connections.

[Afișare globală produse din familie.](#)

Supus modificărilor.