

Descriere articol

- Protected against mismatching and maintenance-free
- Push-in CAGE CLAMP® spring pressure connection technology allows solid conductors to be simply pushed into a unit
- Compact design with 4.4 mm pole spacing
- Components can be clearly printed on and color-coded to meet custom requirements
- When assembled, the installation connectors complies with IP40 and are suitable for easily accessible areas

Note:

All connectors for mounted installations (snap-in versions for lighting fixtures or devices, all types of PCB and distribution connectors) are factory-equipped with locking levers to ensure plugs and sockets are securely locked. Additional locking levers are only required for flying leads (plug /socket).

Note on mismatching protection:

All WINSTA® components are 100% protected against mismatching when:

- a.) plugging different numbers of poles
- b.) plugging while rotated 180
- c.) plugging while laterally staggered
- d.) plugging one pole

Safety information 1:

Supus modificărilor.



Application note for the U.S. market (USR): Some versions may also be used for current interruption in accordance with the UL certificate in select applications with currents below 5 A and voltages up to 600 V. For further information, please contact your local sales office.

Date

Electrical data

Note on Contact Resistance	approx. 1 mΩ of contact resistance approx. 0.25 mΩ contact transition plug/socket
----------------------------	---

Ratings per IEC/EN 60664-1

Ratings per	IEC/EN 60664-1
Nominal voltage (III/3)	250 V
Rated surge voltage (III/3)	4 kV
Rated current	16 A
Note on rated current	13 A for 3-pole load
Legend (ratings)	(III / 3) ≙ Overvoltage category III / Pollution degree 3

Approvals per UL 1977

Rated voltage UL 1977	600 V
Rated current UL 1977	14 A

Connection data

Connection technology	Push-in CAGE CLAMP®
Actuation type	Operating tool Push-in
Nominal cross-section	1,5 mm ²
Solid conductor	0,25 ... 1,5 mm ² / 22 ... 16 AWG
Solid conductor; push-in termination	0,75 ... 1,5 mm ² / 20 ... 16 AWG
Stranded conductor	0,25 ... 1 mm ² / 22 ... 18 AWG
Fine-stranded conductor	0,25 ... 1,5 mm ² / 22 ... 16 AWG
Fine-stranded conductor; with insulated ferrule	0,25 ... 0,75 mm ² / 22 ... 20 AWG
Fine-stranded conductor; with uninsulated ferrule	0,25 ... 0,75 mm ² / 22 ... 20 AWG
Fine-stranded conductor; with ferrule; push-in termination	0,75 mm ² / 20 AWG
Strip length	9 mm / 0.35 inch
Note (strip length)	see also packaging or instructions
Pole No.	3
Total number of connection points	3
Total number of potentials	3

Supus modificărilor.

WAGO Kontakttechnik GmbH & Co. KG
/Representative Office Romania
Sos. Pipera-Tunari nr. 1/1
building 1, 2nd floor | 077190 Voluntari, Ilfov
Tel.: +40-(0)31 421 85 68 | Email: info-RO@wago.com

Aveți întrebări despre produsele noastre?
Vă stăm la dispoziție pentru preluarea apelului la +40 (0) 31 421 85 68.



Conductor entry direction to mating direction	0°
---	----

Geometrical Data

Pin spacing	4,4 mm / 0.173 inch
Width	15 mm / 0.591 inch
Height	11,7 mm / 0.461 inch
Depth	34,1 mm / 1.343 inch

Mechanical data

Coding	B
Mating force of a plug-in connection	approx. 20 ... 70 N (depending on pole number)
Retention force of a plug-in connection	Locked: > 80 N
Unmating force of a plug-in connection	Unlocked: approx. 20 ... 70 N (depending on pole number)
Number of mating cycles	200, without resistive load 100, with resistive load $I_N = 16$ A, tested (1.5 mm ² /16 AWG)
Marking	1 2 3
Protection type	IP20
Note on protection type	IP40 when mated with strain relief housing
Potential marking	1 2 3

Plug connection

Contact type (pluggable connector)	Male connector/plug
Connector (connection type)	for conductor
Mismating protection	Yes
Locking of plug-in connection	locking lever
Locking lever	retrofitable

Material Data

Color	light green
Insulation material	Polyamide 66 (PA 66)
Clamping spring material	Chrome nickel spring steel (CrNi)
Contact material	Copper or copper alloy (surface-treated)
Fire load	0,077 MJ
Weight	3,4 g

Supus modificărilor.

WAGO Kontakttechnik GmbH & Co. KG
/Representative Office Romania
Sos. Pipera-Tunari nr. 1/1
building 1, 2nd floor | 077190 Voluntari, Ilfov
Tel.: +40-(0)31 421 85 68 | Email: info-RO@wago.com

Aveți întrebări despre produsele noastre?
Vă stăm la dispoziție pentru preluarea apelului la +40 (0) 31 421 85 68.

Environmental Requirements



Processing temperature	-5 ... +40 °C
Continuous operating temperature	-35 ... +85 °C
Note on continuous operating temperature	Insulating parts for temperatures ≤ 105 °C

Commercial data



Product Group	20 (WINSTA)
Packaging type	BOX
Country of origin	PL
GTIN	4055143499996
Customs tariff number	85366990990

Aprobări / certificate

Country specific Approvals

Emblemă	Aprobare	Text de aprobare suplimentar	Nume certificat
	CB DEKRA Certification B.V.	EN 61984	71-100413
	CCA DEKRA Certification B.V.	EN 60320	2148952.04

Ship Approvals

Emblemă	Aprobare	Text de aprobare suplimentar	Nume certificat
	DNV GL Det Norske Veritas, Germanischer Lloyd	-	TAE00001Z6
	LR Lloyds Register	EN 61535	08/20047 (E2)

UL-Approvals

Emblemă	Aprobare	Text de aprobare suplimentar	Nume certificat

Supus modificărilor.



cURus
Underwriters Laboratories Inc.

UL 1977

E45171

Counterpart



Nr. articol 890-1662

h-distribution connector; 3-pole; Cod. B; 1 input; 2 outputs; outputs on one side; 2 locking levers; light green www.wago.com/890-1662



Nr. articol 890-1762

h-distribution connector; 3-pole; Cod. B; 1 input; 2 outputs; outputs on one side; 3 locking levers; for flying leads; light green www.wago.com/890-1762



Nr. articol 890-263

Socket; 3-pole; Cod. B; 1,50 mm²; light green

www.wago.com/890-263



Nr. articol 890-763

Snap-in socket; 3-pole; Cod. B; 1,50 mm²; light green

www.wago.com/890-763



Nr. articol 890-863

Socket for PCBs; straight; 3-pole; Cod. B

www.wago.com/890-863



Nr. articol 890-863/011-000

Socket for PCBs; angled; 3-pole; Cod. B

www.wago.com/890-863/011-000



Nr. articol 891-8993/005-105

pre-assembled interconnecting cable; Socket/plug; 3-pole; Cod. B; 1 m; 1,00 mm²; light green

www.wago.com/891-8993/005-105



Nr. articol 891-8993/105-105

pre-assembled connecting cable; Eca; Socket/open-ended; 3-pole; Cod. B; 1 m; 1,00 mm²; light green

www.wago.com/891-8993/105-105

Produse compatibile

tools



Nr. articol: 210-719

Operating tool; Blade: 2.5 x 0.4 mm; with a partially insulated shaft

www.wago.com/210-719

Descărcări

CAD/CAE-Data

Supus modificărilor.

WAGO Kontakttechnik GmbH & Co. KG
/Representative Office Romania
Sos. Pipera-Tunari nr. 1/1
building 1, 2nd floor | 077190 Voluntari, Ilfov
Tel.: +40-(0)31 421 85 68 | Email: info-RO@wago.com

Aveți întrebări despre produsele noastre?
Vă stăm la dispoziție pentru preluarea apelului la +40 (0) 31 421 85 68.

CAD data

2D/3D Models 890-273

[URL](#)

[Descărcare](#)

CAE data

WSCAD Universe 890-273

[URL](#)

[Descărcare](#)

Installation Notes

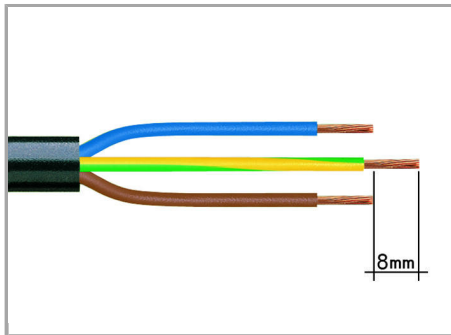

1. Strip length, outer insulation = 30 mm (2-pole), 37 mm (3-pole), 45 mm (4- and 5-pole)

2. Strip length = 9 mm

3. Extended ground conductor = 8 mm

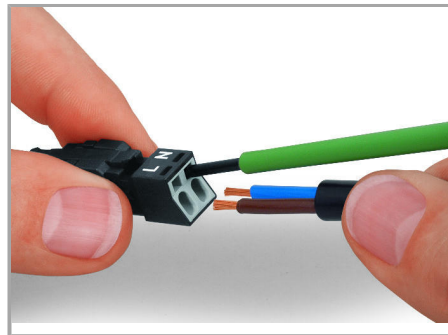

To terminate fine-stranded conductors, open the clamping unit via screwdriver (2.5 mm blade width) and insert a stripped conductor until it hits backstop. Terminate solid conductors by simply pushing them in.

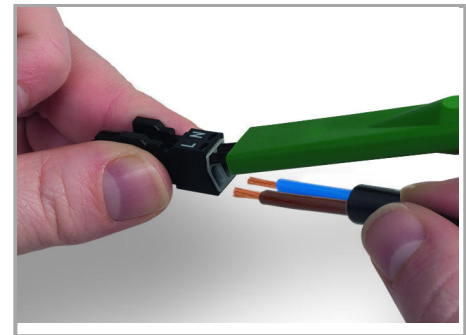

To terminate fine-stranded conductors, open clamping units via operating tool (890-382) and insert stripped conductors until they hit backstop.

Terminate solid conductors by simply pushing them in.

Supus modificărilor.



To terminate fine-stranded conductors, open clamping units via operating tool (890-383) and insert stripped conductors until they hit backstop.

Terminate solid conductors by simply pushing them in.

Installation

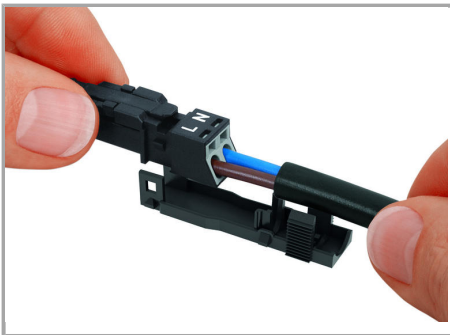

Latch wired connector onto the base of the strain relief housing.

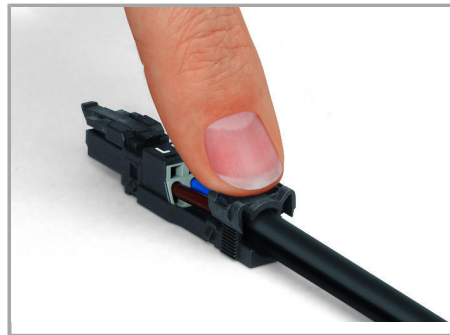

Push down strain relief clamp by hand.



Push down strain relief clamp via 2.5 mm screwdriver alternately on both sides.

Supus modificărilor.



Latch the top of the strain relief housing.



The printed marking of the connector is clearly visible in the openings of the strain relief housing.

Mismatching protection

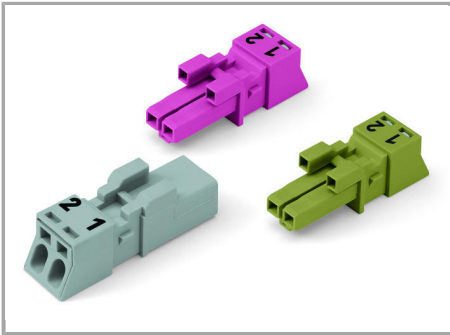

B-coded connectors with different colors can be plugged together.

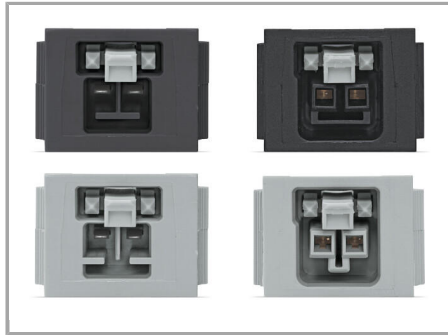

B-coded connectors (shown in gray) not only differ in color, but also in their design, making them incompatible with other coded connectors.



Important note:

Different colors and/or pole marking are used for circuit identification. Only connectors of the same color and same pole marking must be plugged together.

Familie de produse

<i>WINSTA</i>® MINI special
Afișare globală produse din familie.

Supus modificărilor.