

## Fișă tehnică | Număr articol: 2022-1204

1-conductor/1-pin carrier terminal block; for DIN-rail 35 x 15 and 35 x 7.5;  
2.5 mm<sup>2</sup>; Push-in CAGE CLAMP®; 2,50 mm<sup>2</sup>; blue

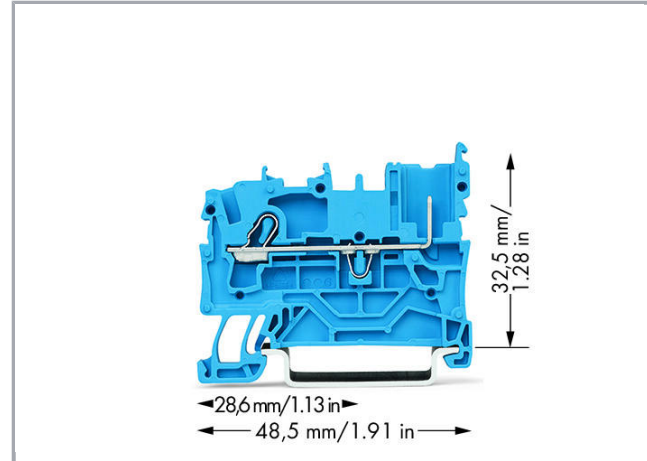

[www.wago.com/2022-1204](http://www.wago.com/2022-1204)



RoHS  Compliant

BOMcheck.net

Culoare: ■

### Date

### Electrical data

### Ratings per IEC/EN 60664-1

| Ratings per                 | IEC/EN 60947-7-1  |
|-----------------------------|---|
| Nominal voltage (III/3)     | 690 V   |
| Rated surge voltage (III/3) | 6 kV  |
| Rated current               | 24 A  |
| Rated current 2             | 32 A  |
| Legend (ratings)            | (III / 3) ≙ Overvoltage category III / Pollution degree 3 |

Supus modificărilor.

WAGO Kontakttechnik GmbH & Co. KG  
/Representative Office Romania  
Sos. Pipera-Tunari nr. 1/1  
building 1, 2nd floor | 077190 Voluntari, Ilfov  
Tel.: +40-(0)31 421 85 68 | Email: info-RO@wago.com

Aveți întrebări despre produsele noastre?  
Vă stăm la dispoziție pentru preluarea apelului la +40 (0) 31 421 85 68.



## Connection data

|  |   |
|--|---|
| Connection technology                                      | Push-in CAGE CLAMP®   |
| Actuation type   | Open Tool Slot<br>Push-in   |
| Connectable conductor materials                            | Copper  |
| Nominal cross-section                                      | 2.5 mm <sup>2</sup>   |
| Solid conductor  | 0.25 ... 4 mm <sup>2</sup> / 22 ... 12 AWG  |
| Solid conductor; push-in termination                       | 0.75 ... 4 mm <sup>2</sup> / 18 ... 12 AWG  |
| Fine-stranded conductor                                    | 0.25 ... 4 mm <sup>2</sup> / 22 ... 12 AWG  |
| Fine-stranded conductor; with insulated ferrule            | 1 ... 2.5 mm <sup>2</sup> / 18 ... 12 AWG   |
| Fine-stranded conductor; with ferrule; push-in termination | 1 ... 2.5 mm <sup>2</sup> / 18 ... 12 AWG   |
| Strip length   | 10 ... 12 mm / 0.39 ... 0.47 inch   |
| Total number of connection points                          | 1   |
| Total number of potentials                                 | 1   |
| Number of levels   | 1   |
| Wiring type  | Front-entry wiring  |
| Note (conductor cross-section)                             | Depending on the conductor characteristic, a conductor with a smaller cross section can also be inserted via push-in termination. |

## Geometrical Data

|                                    |                      |
|------------------------------------|----------------------|
| Width                              | 5.2 mm / 0.205 inch  |
| Height from upper-edge of DIN-rail | 32.5 mm / 1.28 inch  |
| Depth                              | 48.5 mm / 1.909 inch |

## Mechanical data

|               |                     |
|---------------|---------------------|
| Design        | horizontal          |
| Mounting type | DIN-35 rail         |
| Marking level | Center/side marking |

## Material Data

|                     |                      |
|---------------------|----------------------|
| Color               | blue                 |
| Insulation material | Polyamide 66 (PA 66) |
| Fire load           | 0,112 MJ             |
| Weight              | 5 g                  |

Supus modificărilor.



WAGO Kontakttechnik GmbH & Co. KG  
/Representative Office Romania  
Sos. Pipera-Tunari nr. 1/1  
building 1, 2nd floor | 077190 Voluntari, Ilfov  
Tel.: +40-(0)31 421 85 68 | Email: info-RO@wago.com

Aveți întrebări despre produsele noastre?  
Vă stăm la dispoziție pentru preluarea apelului la +40 (0) 31 421 85 68.

**Commercial data**

|                       |                   |
|-----------------------|-------------------|
| Product Group         | 18 (X-COM-System) |
| Packaging type        | BOX               |
| Country of origin     | CN                |
| GTIN                  | 4050821145073     |
| Customs tariff number | 85366990990       |

**Aprobări / certificate****Country specific Approvals**

| Emblemă  | Aprobare                               | Text de aprobare suplimentar | Nume certificat |
|--|--|------------------------------|-----------------|
|  | <b>CCA</b><br>DEKRA Certification B.V. | EN 60947                     | NTR NL<br>7628  |
|  | <b>CSA</b><br>DEKRA Certification B.V. | C22.2 No. 158                | 2437422         |

**UL-Approvals**

| Emblemă  | Aprobare                                    | Text de aprobare suplimentar | Nume certificat |
|--|---|------------------------------|-----------------|
|  | <b>UR</b><br>Underwriters Laboratories Inc. | UL 1059                      | E45172          |

**Counterpart****Produse compatibile**

Supus modificărilor.

WAGO Kontakttechnik GmbH & Co. KG  
/Representative Office Romania  
Sos. Pipera-Tunari nr. 1/1  
building 1, 2nd floor | 077190 Voluntari, Ilfov  
Tel.: +40-(0)31 421 85 68 | Email: info-RO@wago.com

Aveți întrebări despre produsele noastre?  
Vă stăm la dispoziție pentru preluarea apelului la +40 (0) 31 421 85 68.

## Coding

**Nr. articol: 2022-100**

Carrier with 6 coding pins; for coding of female plugs; orange

[www.wago.com/2022-100](http://www.wago.com/2022-100)

## Insulation stop

**Nr. articol: 2002-171**Insulation stop; 0.25 - 0.5 mm<sup>2</sup>; 5 pieces/strip; light gray[www.wago.com/2002-171](http://www.wago.com/2002-171)**Nr. articol: 2002-172**Insulation stop; 0.75 - 1 mm<sup>2</sup>; 5 pieces/strip; dark gray[www.wago.com/2002-172](http://www.wago.com/2002-172)

## ferrule

**Nr. articol: 216-241**Ferrule; Sleeve for 0.5 mm<sup>2</sup> / 20 AWG; insulated; electro-tin plated; electrolytic copper; gastight crimped; acc. to DIN 46228, Part 4/09.90; white[www.wago.com/216-241](http://www.wago.com/216-241)**Nr. articol: 216-242**Ferrule; Sleeve for 0.75 mm<sup>2</sup> / 18 AWG; insulated; electro-tin plated; electrolytic copper; gastight crimped; acc. to DIN 46228, Part 4/09.90; gray[www.wago.com/216-242](http://www.wago.com/216-242)**Nr. articol: 216-243**Ferrule; Sleeve for 1 mm<sup>2</sup> / AWG 18; insulated; electro-tin plated; electrolytic copper; gastight crimped; acc. to DIN 46228, Part 4/09.90; red[www.wago.com/216-243](http://www.wago.com/216-243)**Nr. articol: 216-244**Ferrule; Sleeve for 1.5 mm<sup>2</sup> / AWG 16; insulated; electro-tin plated; electrolytic copper; gastight crimped; acc. to DIN 46228, Part 4/09.90; black[www.wago.com/216-244](http://www.wago.com/216-244)**Nr. articol: 216-246**Ferrule; Sleeve for 2.5 mm<sup>2</sup> / AWG 14; insulated; electro-tin plated; electrolytic copper; gastight crimped; acc. to DIN 46228, Part 4/09.90; blue[www.wago.com/216-246](http://www.wago.com/216-246)**Nr. articol: 216-262**Ferrule; Sleeve for 0.75 mm<sup>2</sup> / 18 AWG; insulated; electro-tin plated; electrolytic copper; gastight crimped; acc. to DIN 46228, Part 4/09.90; gray[www.wago.com/216-262](http://www.wago.com/216-262)**Nr. articol: 216-263**Ferrule; Sleeve for 1 mm<sup>2</sup> / AWG 18; insulated; electro-tin plated; electrolytic copper; gastight crimped; acc. to DIN 46228, Part 4/09.90; red[www.wago.com/216-263](http://www.wago.com/216-263)**Nr. articol: 216-264**Ferrule; Sleeve for 1.5 mm<sup>2</sup> / AWG 16; insulated; electro-tin plated; electrolytic copper; gastight crimped; acc. to DIN 46228, Part 4/09.90; black[www.wago.com/216-264](http://www.wago.com/216-264)**Nr. articol: 216-266**Ferrule; Sleeve for 2.5 mm<sup>2</sup> / AWG 14; insulated; electro-tin plated; electrolytic copper; gastight crimped; acc. to DIN 46228, Part 4/09.90; blue[www.wago.com/216-266](http://www.wago.com/216-266)**Nr. articol: 216-284**Ferrule; Sleeve for 1.5 mm<sup>2</sup> / AWG 16; insulated; electro-tin plated; electrolytic copper; gastight crimped; acc. to DIN 46228, Part 4/09.90; black[www.wago.com/216-284](http://www.wago.com/216-284)**Nr. articol: 216-286**Ferrule; Sleeve for 2.5 mm<sup>2</sup> / AWG 14; insulated; electro-tin plated; electrolytic copper; gastight crimped; acc. to DIN 46228, Part 4/09.90; blue[www.wago.com/216-286](http://www.wago.com/216-286)

Supus modificărilor.

## tools

**Nr. articol: 210-720**

Operating tool; Blade: 3.5 x 0.5 mm; with a partially insulated shaft

[www.wago.com/210-720](http://www.wago.com/210-720)

## Protective Warning Marker

**Nr. articol: 2002-115**

Protective warning marker; with high-voltage symbol, black; for 5 terminal blocks; yellow

[www.wago.com/2002-115](http://www.wago.com/2002-115)

## Marking accessories

**Nr. articol: 2002-161**

Adaptor

[www.wago.com/2002-161](http://www.wago.com/2002-161)**Nr. articol: 2009-110**

Marking strips; on reel; not stretchable; plain; snap-on type; white

[www.wago.com/2009-110](http://www.wago.com/2009-110)**Nr. articol: 2009-115**

WMB-Inline; for Smart Printer; 1500 pieces on roll; stretchable 5 - 5.2 mm; plain; snap-on type; white

[www.wago.com/2009-115](http://www.wago.com/2009-115)**Nr. articol: 2009-115/000-002**

WMB-Inline; for Smart Printer; 1500 pieces on roll; stretchable 5 - 5.2 mm; plain; snap-on type; yellow

[www.wago.com/2009-115](http://www.wago.com/2009-115)

/000-002

**Nr. articol: 2009-115/000-005**

WMB-Inline; for Smart Printer; 1500 pieces on roll; stretchable 5 - 5.2 mm; plain; snap-on type; red

[www.wago.com/2009-115](http://www.wago.com/2009-115)

/000-005

**Nr. articol: 2009-115/000-006**

WMB-Inline; for Smart Printer; 1500 pieces on roll; stretchable 5 - 5.2 mm; plain; snap-on type; blue

[www.wago.com/2009-115](http://www.wago.com/2009-115)

/000-006

**Nr. articol: 2009-115/000-007**

WMB-Inline; for Smart Printer; 1500 pieces on roll; stretchable 5 - 5.2 mm; plain; snap-on type; gray

[www.wago.com/2009-115](http://www.wago.com/2009-115)

/000-007

**Nr. articol: 2009-115/000-012**

WMB-Inline; for Smart Printer; 1500 pieces on roll; stretchable 5 - 5.2 mm; plain; snap-on type; orange

[www.wago.com/2009-115](http://www.wago.com/2009-115)

/000-012

**Nr. articol: 2009-115/000-017**

WMB-Inline; for Smart Printer; 1500 pieces on roll; stretchable 5 - 5.2 mm; plain; snap-on type; light green

[www.wago.com/2009-115](http://www.wago.com/2009-115)

/000-017

**Nr. articol: 2009-115/000-023**

WMB-Inline; for Smart Printer; 1500 pieces on roll; stretchable 5 - 5.2 mm; plain; snap-on type; green

[www.wago.com/2009-115](http://www.wago.com/2009-115)

/000-023

**Nr. articol: 2009-115/000-024**

WMB-Inline; for Smart Printer; 1500 pieces on roll; stretchable 5 - 5.2 mm; plain; snap-on type; violet

[www.wago.com/2009-115](http://www.wago.com/2009-115)

/000-024

**Nr. articol: 2009-145**

Mini-WSB Inline; for Smart Printer; 1700 pieces on roll; stretchable 5 - 5.2 mm; plain; snap-on type; white

[www.wago.com/2009-145](http://www.wago.com/2009-145)

Supus modificărilor.

WAGO Kontakttechnik GmbH &amp; Co. KG

/Representative Office Romania















Sos. Pipera-Tunari nr. 1/1

building 1, 2nd floor | 077190 Voluntari, Ilfov













Tel.: +40-(0)31 421 85 68 | Email: info-RO@wago.com

Aveți întrebări despre produsele noastre?

Vă stăm la dispoziție pentru preluarea apelului la +40 (0) 31 421 85 68.

|  |  |  |
|--|--|--|
|    | <b>Nr. articol: 2009-145/000-002</b><br>Mini-WSB Inline; for Smart Printer; 1700 pieces on roll; stretchable 5 - 5.2 mm; plain; snap-on type; yellow | <a href="http://www.wago.com/2009-145/000-002">www.wago.com/2009-145/000-002</a> |
|    | <b>Nr. articol: 2009-145/000-005</b><br>Mini-WSB Inline; for Smart Printer; 1700 pieces on roll; stretchable 5 - 5.2 mm; plain; snap-on type; red    | <a href="http://www.wago.com/2009-145/000-005">www.wago.com/2009-145/000-005</a> |
|    | <b>Nr. articol: 2009-145/000-006</b><br>Mini-WSB Inline; for Smart Printer; 1700 pieces on roll; stretchable 5 - 5.2 mm; plain; snap-on type; blue   | <a href="http://www.wago.com/2009-145/000-006">www.wago.com/2009-145/000-006</a> |
|    | <b>Nr. articol: 2009-145/000-007</b><br>Mini-WSB Inline; for Smart Printer; 1700 pieces on roll; stretchable 5 - 5.2 mm; plain; snap-on type; gray   | <a href="http://www.wago.com/2009-145/000-007">www.wago.com/2009-145/000-007</a> |
|    | <b>Nr. articol: 2009-145/000-012</b><br>Mini-WSB Inline; for Smart Printer; 1700 pieces on roll; stretchable 5 - 5.2 mm; plain; snap-on type; orange | <a href="http://www.wago.com/2009-145/000-012">www.wago.com/2009-145/000-012</a> |
|    | <b>Nr. articol: 2009-145/000-023</b><br>Mini-WSB Inline; for Smart Printer; 1700 pieces on roll; stretchable 5 - 5.2 mm; plain; snap-on type; green  | <a href="http://www.wago.com/2009-145/000-023">www.wago.com/2009-145/000-023</a> |
|   | <b>Nr. articol: 2009-145/000-024</b><br>Mini-WSB Inline; for Smart Printer; 1700 pieces on roll; stretchable 5 - 5.2 mm; plain; snap-on type; violet | <a href="http://www.wago.com/2009-145/000-024">www.wago.com/2009-145/000-024</a> |
|  | <b>Nr. articol: 2009-191</b><br>Group marker carrier   | <a href="http://www.wago.com/2009-191">www.wago.com/2009-191</a>                 |
|  | <b>Nr. articol: 2009-192</b><br>Group marker carrier   | <a href="http://www.wago.com/2009-192">www.wago.com/2009-192</a>                 |
|  | <b>Nr. articol: 2009-193</b><br>Group marker carrier   | <a href="http://www.wago.com/2009-193">www.wago.com/2009-193</a>                 |
|  | <b>Nr. articol: 2009-198</b><br>Adaptor  | <a href="http://www.wago.com/2009-198">www.wago.com/2009-198</a>                 |
|  | <b>Nr. articol: 248-501</b><br>Miniature WSB Quick marking system; plain; Marker width 5 mm; 10 strips with 10 markers per card                      | <a href="http://www.wago.com/248-501">www.wago.com/248-501</a>                   |
|  | <b>Nr. articol: 248-501/000-002</b><br>Mini-WSB marking card; as card; not stretchable; plain; snap-on type; yellow                                  | <a href="http://www.wago.com/248-501/000-002">www.wago.com/248-501/000-002</a>   |
|  | <b>Nr. articol: 248-501/000-005</b><br>Mini-WSB marking card; as card; not stretchable; plain; snap-on type; red                                     | <a href="http://www.wago.com/248-501/000-005">www.wago.com/248-501/000-005</a>   |
|  | <b>Nr. articol: 248-501/000-006</b><br>Mini-WSB marking card; as card; not stretchable; plain; snap-on type; blue                                    | <a href="http://www.wago.com/248-501/000-006">www.wago.com/248-501/000-006</a>   |

Supus modificărilor.

|  |  |  |
|--|--|--|
|    | <b>Nr. articol: 248-501/000-007</b><br>Mini-WSB marking card; as card; not stretchable; plain; snap-on type; gray        | <a href="http://www.wago.com/248-501/000-007">www.wago.com/248-501/000-007</a> |
|    | <b>Nr. articol: 248-501/000-012</b><br>Mini-WSB marking card; as card; not stretchable; plain; snap-on type; orange      | <a href="http://www.wago.com/248-501/000-012">www.wago.com/248-501/000-012</a> |
|    | <b>Nr. articol: 248-501/000-017</b><br>Mini-WSB marking card; as card; not stretchable; plain; snap-on type; light green | <a href="http://www.wago.com/248-501/000-017">www.wago.com/248-501/000-017</a> |
|    | <b>Nr. articol: 248-501/000-023</b><br>Mini-WSB marking card; as card; not stretchable; plain; snap-on type; green       | <a href="http://www.wago.com/248-501/000-023">www.wago.com/248-501/000-023</a> |
|    | <b>Nr. articol: 248-501/000-024</b><br>Mini-WSB marking card; as card; not stretchable; plain; snap-on type; violet      | <a href="http://www.wago.com/248-501/000-024">www.wago.com/248-501/000-024</a> |
|    | <b>Nr. articol: 793-501</b><br>WMB marking card; as card; not stretchable; plain; snap-on type; white                    | <a href="http://www.wago.com/793-501">www.wago.com/793-501</a>                 |
|   | <b>Nr. articol: 793-501/000-002</b><br>WMB marking card; as card; not stretchable; plain; snap-on type; yellow           | <a href="http://www.wago.com/793-501/000-002">www.wago.com/793-501/000-002</a> |
|  | <b>Nr. articol: 793-501/000-005</b><br>WMB marking card; as card; not stretchable; plain; snap-on type; red              | <a href="http://www.wago.com/793-501/000-005">www.wago.com/793-501/000-005</a> |
|  | <b>Nr. articol: 793-501/000-006</b><br>WMB marking card; as card; not stretchable; plain; snap-on type; blue             | <a href="http://www.wago.com/793-501/000-006">www.wago.com/793-501/000-006</a> |
|  | <b>Nr. articol: 793-501/000-007</b><br>WMB marking card; as card; not stretchable; plain; snap-on type; gray             | <a href="http://www.wago.com/793-501/000-007">www.wago.com/793-501/000-007</a> |
|  | <b>Nr. articol: 793-501/000-012</b><br>WMB marking card; as card; not stretchable; plain; snap-on type; orange           | <a href="http://www.wago.com/793-501/000-012">www.wago.com/793-501/000-012</a> |
|  | <b>Nr. articol: 793-501/000-017</b><br>WMB marking card; as card; not stretchable; plain; snap-on type; light green      | <a href="http://www.wago.com/793-501/000-017">www.wago.com/793-501/000-017</a> |
|  | <b>Nr. articol: 793-501/000-023</b><br>WMB marking card; as card; not stretchable; plain; snap-on type; green            | <a href="http://www.wago.com/793-501/000-023">www.wago.com/793-501/000-023</a> |

Supus modificărilor.

WAGO Kontakttechnik GmbH & Co. KG  
/Representative Office Romania  
Sos. Pipera-Tunari nr. 1/1  
building 1, 2nd floor | 077190 Voluntari, Ilfov  
Tel.: +40-(0)31 421 85 68 | Email: info-RO@wago.com

Aveți întrebări despre produsele noastre?  
Vă stăm la dispoziție pentru preluarea apelului la +40 (0) 31 421 85 68.

**Nr. articol:** 793-501/000-024

WMB marking card; as card; not stretchable; plain; snap-on type; violet

[www.wago.com/793-501/000-024](http://www.wago.com/793-501/000-024)**Nr. articol:** 793-5501

WMB marking card; as card; for terminal block width 5 - 17.5 mm; stretchable 5 - 5.2 mm; plain; snap-on type; white

[www.wago.com/793-5501](http://www.wago.com/793-5501)**Nr. articol:** 793-5501/000-002

WMB marking card; as card; for terminal block width 5 - 17.5 mm; stretchable 5 - 5.2 mm; plain; snap-on type; yellow

[www.wago.com/793-5501/000-002](http://www.wago.com/793-5501/000-002)**Nr. articol:** 793-5501/000-005

WMB marking card; as card; for terminal block width 5 - 17.5 mm; stretchable 5 - 5.2 mm; plain; snap-on type; red

[www.wago.com/793-5501/000-005](http://www.wago.com/793-5501/000-005)**Nr. articol:** 793-5501/000-006

WMB marking card; as card; for terminal block width 5 - 17.5 mm; stretchable 5 - 5.2 mm; plain; snap-on type; blue

[www.wago.com/793-5501/000-006](http://www.wago.com/793-5501/000-006)**Nr. articol:** 793-5501/000-007

WMB marking card; as card; for terminal block width 5 - 17.5 mm; stretchable 5 - 5.2 mm; plain; snap-on type; gray

[www.wago.com/793-5501/000-007](http://www.wago.com/793-5501/000-007)**Nr. articol:** 793-5501/000-012

WMB marking card; as card; for terminal block width 5 - 17.5 mm; stretchable 5 - 5.2 mm; plain; snap-on type; orange

[www.wago.com/793-5501/000-012](http://www.wago.com/793-5501/000-012)**Nr. articol:** 793-5501/000-014

WMB marking card; as card; for terminal block width 5 - 17.5 mm; stretchable 5 - 5.2 mm; plain; snap-on type; brown

[www.wago.com/793-5501/000-014](http://www.wago.com/793-5501/000-014)**Nr. articol:** 793-5501/000-017

WMB marking card; as card; for terminal block width 5 - 17.5 mm; stretchable 5 - 5.2 mm; plain; snap-on type; green

[www.wago.com/793-5501/000-017](http://www.wago.com/793-5501/000-017)**Nr. articol:** 793-5501/000-023

WMB marking card; as card; for terminal block width 5 - 17.5 mm; stretchable 5 - 5.2 mm; plain; snap-on type; light green

[www.wago.com/793-5501/000-023](http://www.wago.com/793-5501/000-023)**Nr. articol:** 793-5501/000-024

WMB marking card; as card; for terminal block width 5 - 17.5 mm; stretchable 5 - 5.2 mm; plain; snap-on type; violet

[www.wago.com/793-5501/000-024](http://www.wago.com/793-5501/000-024)**Carrier rail****Nr. articol:** 210-112

Steel carrier rail; 35 x 7.5 mm; 1 mm thick; 2 m long; slotted; according to EN 60715; "Hole width 25 mm

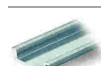
[www.wago.com/210-112](http://www.wago.com/210-112)**Nr. articol:** 210-113

Steel carrier rail; 35 x 7.5 mm; 1 mm thick; 2 m long; unslotted; according to EN 60715

















[www.wago.com/210-113](http://www.wago.com/210-113)**Nr. articol:** 210-114

Steel carrier rail; 35 x 15 mm; 1.5 mm thick; 2 m long; unslotted; similar to EN 60715

[www.wago.com/210-114](http://www.wago.com/210-114)

Supus modificărilor.







|  |   |  |
|--|---|--|
|    | <b>Nr. articol: 210-115</b><br>Steel carrier rail; 35 x 7.5 mm; 1 mm thick; 2 m long; slotted; according to EN 60715; "Hole width 18 mm                                     | <a href="http://www.wago.com/210-115">www.wago.com/210-115</a>   |
|    | <b>Nr. articol: 210-118</b><br>Steel carrier rail; 35 x 15 mm; 2.3 mm thick; 2 m long; unslotted; according to EN 60715   | <a href="http://www.wago.com/210-118">www.wago.com/210-118</a>   |
|    | <b>Nr. articol: 210-196</b><br>Aluminum carrier rail; 35 x 8.2 mm; 1.6 mm thick; 2 m long; unslotted; similar to EN 60715; silver-colored                                   | <a href="http://www.wago.com/210-196">www.wago.com/210-196</a>   |
|    | <b>Nr. articol: 210-197</b><br>Steel carrier rail; 35 x 15 mm; 1.5 mm thick; 2 m long; slotted; similar to EN 60715   | <a href="http://www.wago.com/210-197">www.wago.com/210-197</a>   |
|    | <b>Nr. articol: 210-198</b><br>Copper carrier rail; 35 x 15 mm; 2.3 mm thick; 2 m long; unslotted; according to EN 60715; copper-colored                                    | <a href="http://www.wago.com/210-198">www.wago.com/210-198</a>   |
| <b>General accessories</b>   |   |  |
|    | <b>Nr. articol: 2022-161</b><br>Start module for 1-conductor female connector; with integrated end plate; 2.5 mm <sup>2</sup> ; 1-pole; 2,50 mm <sup>2</sup> ; gray         | <a href="http://www.wago.com/2022-161">www.wago.com/2022-161</a> |
|    | <b>Nr. articol: 2022-162</b><br>Start module for 1-conductor female connector; with integrated end plate; 2.5 mm <sup>2</sup> ; 1-pole; 2,50 mm <sup>2</sup> ; orange       | <a href="http://www.wago.com/2022-162">www.wago.com/2022-162</a> |
|   | <b>Nr. articol: 2022-164</b><br>Start module for 1-conductor female connector; with integrated end plate; 2.5 mm <sup>2</sup> ; 1-pole; 2,50 mm <sup>2</sup> ; blue         | <a href="http://www.wago.com/2022-164">www.wago.com/2022-164</a> |
|  | <b>Nr. articol: 2022-167</b><br>Start module for 1-conductor female connector; with integrated end plate; 2.5 mm <sup>2</sup> ; 1-pole; 2,50 mm <sup>2</sup> ; green-yellow | <a href="http://www.wago.com/2022-167">www.wago.com/2022-167</a> |
|  | <b>Nr. articol: 2022-171</b><br>Center module for 1-conductor female connector; 2.5 mm <sup>2</sup> ; 1-pole; 2,50 mm <sup>2</sup> ; gray                                   | <a href="http://www.wago.com/2022-171">www.wago.com/2022-171</a> |
|  | <b>Nr. articol: 2022-172</b><br>Center module for 1-conductor female connector; 2.5 mm <sup>2</sup> ; 1-pole; 2,50 mm <sup>2</sup> ; orange                                 | <a href="http://www.wago.com/2022-172">www.wago.com/2022-172</a> |
|  | <b>Nr. articol: 2022-174</b><br>Center module for 1-conductor female connector; 2.5 mm <sup>2</sup> ; 1-pole; 2,50 mm <sup>2</sup> ; blue                                   | <a href="http://www.wago.com/2022-174">www.wago.com/2022-174</a> |
|  | <b>Nr. articol: 2022-177</b><br>Center module for 1-conductor female connector; 2.5 mm <sup>2</sup> ; 1-pole; 2,50 mm <sup>2</sup> ; green-yellow                           | <a href="http://www.wago.com/2022-177">www.wago.com/2022-177</a> |
|  | <b>Nr. articol: 2022-181</b><br>End module for 1-conductor female connector; 2.5 mm <sup>2</sup> ; 1-pole; 2,50 mm <sup>2</sup> ; gray                                      | <a href="http://www.wago.com/2022-181">www.wago.com/2022-181</a> |
|  | <b>Nr. articol: 2022-182</b><br>End module for 1-conductor female connector; 2.5 mm <sup>2</sup> ; 1-pole; 2,50 mm <sup>2</sup> ; orange                                    | <a href="http://www.wago.com/2022-182">www.wago.com/2022-182</a> |
|  | <b>Nr. articol: 2022-184</b><br>End module for 1-conductor female connector; 2.5 mm <sup>2</sup> ; 1-pole; 2,50 mm <sup>2</sup> ; blue                                      | <a href="http://www.wago.com/2022-184">www.wago.com/2022-184</a> |
|  | <b>Nr. articol: 2022-187</b><br>End module for 1-conductor female connector; 2.5 mm <sup>2</sup> ; 1-pole; 2,50 mm <sup>2</sup> ; green-yellow                              | <a href="http://www.wago.com/2022-187">www.wago.com/2022-187</a> |

Supus modificărilor.







## Push-In type wire jumper

|  |   |  |
|--|---|--|
|  | <b>Nr. articol: 2009-412</b><br>Push-in type wire jumper; insulated; wire length 60 mm; Conductor cross section 1.5 mm <sup>2</sup> ; suitable for 2001, 2002, 2003 and 2022 Series rail-mounted terminal blocks; black         | <a href="http://www.wago.com/2009-412">www.wago.com/2009-412</a>                 |
|  | <b>Nr. articol: 2009-414</b><br>Push-in type wire jumper; insulated; wire length 110 mm; Conductor cross section 1.5 mm <sup>2</sup> ; suitable for 2001, 2002, 2003 and 2022 Series rail-mounted terminal blocks; black        | <a href="http://www.wago.com/2009-414">www.wago.com/2009-414</a>                 |
|  | <b>Nr. articol: 2009-414/000-005</b><br>Push-in type wire jumper; insulated; wire length 110 mm; Conductor cross section 1.5 mm <sup>2</sup> ; suitable for 2001, 2002, 2003 and 2022 Series rail-mounted terminal blocks; red  | <a href="http://www.wago.com/2009-414/000-005">www.wago.com/2009-414/000-005</a> |
|  | <b>Nr. articol: 2009-414/000-006</b><br>Push-in type wire jumper; insulated; wire length 110 mm; Conductor cross section 1.5 mm <sup>2</sup> ; suitable for 2001, 2002, 2003 and 2022 Series rail-mounted terminal blocks; blue | <a href="http://www.wago.com/2009-414/000-006">www.wago.com/2009-414/000-006</a> |
|  | <b>Nr. articol: 2009-416</b><br>Push-in type wire jumper; insulated; wire length 250 mm; Conductor cross section 1.5 mm <sup>2</sup> ; suitable for 2001, 2002, 2003 and 2022 Series rail-mounted terminal blocks; black        | <a href="http://www.wago.com/2009-416">www.wago.com/2009-416</a>                 |

## End plate

|   |   |  |
|---|---|--|
|   | <b>Nr. articol: 2022-1291</b><br>End and intermediate plate; 1 mm thick; gray   | <a href="http://www.wago.com/2022-1291">www.wago.com/2022-1291</a> |
|  | <b>Nr. articol: 2022-1292</b><br>End and intermediate plate; 1 mm thick; orange | <a href="http://www.wago.com/2022-1292">www.wago.com/2022-1292</a> |





## Female plug

|   |  |  |
|---|--|--|
|  | <b>Nr. articol: 2022-101</b><br>1-conductor female plug; 2.5 mm <sup>2</sup> ; 1-pole; 2,50 mm <sup>2</sup> ; gray | <a href="http://www.wago.com/2022-101">www.wago.com/2022-101</a>                 |
|  | <b>Nr. articol: 2022-101/000-006</b><br>1-conductor female plug; 1-pole; 2,50 mm <sup>2</sup> ; blue               | <a href="http://www.wago.com/2022-101/000-006">www.wago.com/2022-101/000-006</a> |
|  | <b>Nr. articol: 2022-101/000-012</b><br>1-conductor female plug; 1-pole; 2,50 mm <sup>2</sup> ; orange             | <a href="http://www.wago.com/2022-101/000-012">www.wago.com/2022-101/000-012</a> |
|  | <b>Nr. articol: 2022-101/000-016</b><br>1-conductor female plug; 1-pole; 2,50 mm <sup>2</sup> ; green-yellow       | <a href="http://www.wago.com/2022-101/000-016">www.wago.com/2022-101/000-016</a> |
|   | <b>Nr. articol: 2022-101/122-000</b><br>1-conductor female plug; 1-pole; 2,50 mm <sup>2</sup> ; gray               | <a href="http://www.wago.com/2022-101/122-000">www.wago.com/2022-101/122-000</a> |
|   | <b>Nr. articol: 2022-101/122-006</b><br>1-conductor female plug; 1-pole; 2,50 mm <sup>2</sup> ; blue               | <a href="http://www.wago.com/2022-101/122-006">www.wago.com/2022-101/122-006</a> |











Supus modificărilor.

WAGO Kontakttechnik GmbH & Co. KG  
/Representative Office Romania  
Sos. Pipera-Tunari nr. 1/1  
building 1, 2nd floor | 077190 Voluntari, Ilfov  
Tel.: +40-(0)31 421 85 68 | Email: info-RO@wago.com











Aveți întrebări despre produsele noastre?  
Vă stăm la dispoziție pentru preluarea apelului la +40 (0) 31 421 85 68.

|  |   |  |
|--|---|--|
|  | <b>Nr. articol: 2022-101/122-016</b><br>1-conductor female plug; 1-pole; 2,50 mm <sup>2</sup> ; green-yellow                                    | <a href="http://www.wago.com/2022-101/122-016">www.wago.com/2022-101/122-016</a> |
|  | <b>Nr. articol: 2022-101/132-000</b><br>1-conductor female plug; Strain relief plate; 1-pole; 2,50 mm <sup>2</sup> ; gray                       | <a href="http://www.wago.com/2022-101/132-000">www.wago.com/2022-101/132-000</a> |
|  | <b>Nr. articol: 2022-101/132-006</b><br>1-conductor female plug; Strain relief plate; 1-pole; 2,50 mm <sup>2</sup> ; blue                       | <a href="http://www.wago.com/2022-101/132-006">www.wago.com/2022-101/132-006</a> |
|  | <b>Nr. articol: 2022-101/132-016</b><br>1-conductor female plug; Strain relief plate; 1-pole; 2,50 mm <sup>2</sup> ; green-yellow               | <a href="http://www.wago.com/2022-101/132-016">www.wago.com/2022-101/132-016</a> |
|  | <b>Nr. articol: 2022-101/142-000</b><br>1-conductor female plug; Strain relief plate; 1-pole; 2,50 mm <sup>2</sup> ; gray                       | <a href="http://www.wago.com/2022-101/142-000">www.wago.com/2022-101/142-000</a> |
|  | <b>Nr. articol: 2022-101/142-006</b><br>1-conductor female plug; Strain relief plate; 1-pole; 2,50 mm <sup>2</sup> ; blue                       | <a href="http://www.wago.com/2022-101/142-006">www.wago.com/2022-101/142-006</a> |
|  | <b>Nr. articol: 2022-101/142-016</b><br>1-conductor female plug; Strain relief plate; 1-pole; 2,50 mm <sup>2</sup> ; green-yellow               | <a href="http://www.wago.com/2022-101/142-016">www.wago.com/2022-101/142-016</a> |
|  | <b>Nr. articol: 2022-102</b><br>1-conductor female plug; 2.5 mm <sup>2</sup> ; 2-pole; 2,50 mm <sup>2</sup> ; gray                              | <a href="http://www.wago.com/2022-102">www.wago.com/2022-102</a>                 |
|  | <b>Nr. articol: 2022-102/000-006</b><br>1-conductor female plug; 2.5 mm <sup>2</sup> ; 2-pole; 2,50 mm <sup>2</sup> ; blue                      | <a href="http://www.wago.com/2022-102/000-006">www.wago.com/2022-102/000-006</a> |
|  | <b>Nr. articol: 2022-102/000-012</b><br>1-conductor female plug; 2.5 mm <sup>2</sup> ; 2-pole; 2,50 mm <sup>2</sup> ; orange                    | <a href="http://www.wago.com/2022-102/000-012">www.wago.com/2022-102/000-012</a> |
|  | <b>Nr. articol: 2022-102/000-016</b><br>1-conductor female plug; 2.5 mm <sup>2</sup> ; 2-pole; 2,50 mm <sup>2</sup> ; green-yellow              | <a href="http://www.wago.com/2022-102/000-016">www.wago.com/2022-102/000-016</a> |
|  | <b>Nr. articol: 2022-102/122-000</b><br>1-conductor female plug; Locking lever; 2.5 mm <sup>2</sup> ; 2-pole; 2,50 mm <sup>2</sup> ; gray       | <a href="http://www.wago.com/2022-102/122-000">www.wago.com/2022-102/122-000</a> |
|  | <b>Nr. articol: 2022-102/132-000</b><br>1-conductor female plug; Strain relief plate; 2.5 mm <sup>2</sup> ; 2-pole; 2,50 mm <sup>2</sup> ; gray | <a href="http://www.wago.com/2022-102/132-000">www.wago.com/2022-102/132-000</a> |
|  | <b>Nr. articol: 2022-102/142-000</b><br>1-conductor female plug; Strain relief plate; 2.5 mm <sup>2</sup> ; 2-pole; 2,50 mm <sup>2</sup> ; gray | <a href="http://www.wago.com/2022-102/142-000">www.wago.com/2022-102/142-000</a> |

Supus modificărilor.

|  |   |  |
|--|---|--|
|    | <b>Nr. articol: 2022-103</b><br>1-conductor female plug; 2.5 mm <sup>2</sup> ; 3-pole; 2,50 mm <sup>2</sup> ; gray                              | <a href="http://www.wago.com/2022-103">www.wago.com/2022-103</a>                 |
|    | <b>Nr. articol: 2022-103/000-006</b><br>1-conductor female plug; 2.5 mm <sup>2</sup> ; 3-pole; 2,50 mm <sup>2</sup> ; blue                      | <a href="http://www.wago.com/2022-103/000-006">www.wago.com/2022-103/000-006</a> |
|    | <b>Nr. articol: 2022-103/000-012</b><br>1-conductor female plug; 2.5 mm <sup>2</sup> ; 3-pole; 2,50 mm <sup>2</sup> ; orange                    | <a href="http://www.wago.com/2022-103/000-012">www.wago.com/2022-103/000-012</a> |
|    | <b>Nr. articol: 2022-103/000-016</b><br>1-conductor female plug; 2.5 mm <sup>2</sup> ; 3-pole; 2,50 mm <sup>2</sup> ; green-yellow              | <a href="http://www.wago.com/2022-103/000-016">www.wago.com/2022-103/000-016</a> |
|    | <b>Nr. articol: 2022-103/000-036</b><br>1-conductor female plug; 2.5 mm <sup>2</sup> ; 3-pole; 2,50 mm <sup>2</sup> ; gray, green-yellow        | <a href="http://www.wago.com/2022-103/000-036">www.wago.com/2022-103/000-036</a> |
|    | <b>Nr. articol: 2022-103/000-037</b><br>1-conductor female plug; 2.5 mm <sup>2</sup> ; 3-pole; 2,50 mm <sup>2</sup> ; green-yellow, gray        | <a href="http://www.wago.com/2022-103/000-037">www.wago.com/2022-103/000-037</a> |
|    | <b>Nr. articol: 2022-103/000-038</b><br>1-conductor female plug; 2.5 mm <sup>2</sup> ; 3-pole; 2,50 mm <sup>2</sup> ; gray, blue, green-yellow  | <a href="http://www.wago.com/2022-103/000-038">www.wago.com/2022-103/000-038</a> |
|  | <b>Nr. articol: 2022-103/000-039</b><br>1-conductor female plug; 2.5 mm <sup>2</sup> ; 3-pole; 2,50 mm <sup>2</sup> ; green-yellow, blue, gray  | <a href="http://www.wago.com/2022-103/000-039">www.wago.com/2022-103/000-039</a> |
|  | <b>Nr. articol: 2022-103/123-000</b><br>1-conductor female plug; Locking lever; 2.5 mm <sup>2</sup> ; 3-pole; 2,50 mm <sup>2</sup> ; gray       | <a href="http://www.wago.com/2022-103/123-000">www.wago.com/2022-103/123-000</a> |
|  | <b>Nr. articol: 2022-103/133-000</b><br>1-conductor female plug; Strain relief plate; 2.5 mm <sup>2</sup> ; 3-pole; 2,50 mm <sup>2</sup> ; gray | <a href="http://www.wago.com/2022-103/133-000">www.wago.com/2022-103/133-000</a> |
|  | <b>Nr. articol: 2022-103/143-000</b><br>1-conductor female plug; Strain relief plate; 2.5 mm <sup>2</sup> ; 3-pole; 2,50 mm <sup>2</sup> ; gray | <a href="http://www.wago.com/2022-103/143-000">www.wago.com/2022-103/143-000</a> |
|  | <b>Nr. articol: 2022-104</b><br>1-conductor female plug; 2.5 mm <sup>2</sup> ; 4-pole; 2,50 mm <sup>2</sup> ; gray                              | <a href="http://www.wago.com/2022-104">www.wago.com/2022-104</a>                 |
|  | <b>Nr. articol: 2022-104/000-006</b><br>1-conductor female plug; 2.5 mm <sup>2</sup> ; 4-pole; 2,50 mm <sup>2</sup> ; blue                      | <a href="http://www.wago.com/2022-104/000-006">www.wago.com/2022-104/000-006</a> |
|  | <b>Nr. articol: 2022-104/000-012</b><br>1-conductor female plug; 2.5 mm <sup>2</sup> ; 4-pole; 2,50 mm <sup>2</sup> ; orange                    | <a href="http://www.wago.com/2022-104/000-012">www.wago.com/2022-104/000-012</a> |

Supus modificărilor.

|   |   |  |
|---|---|--|
|    | <b>Nr. articol: 2022-104/000-016</b><br>1-conductor female plug; 2.5 mm <sup>2</sup> ; 4-pole; 2,50 mm <sup>2</sup> ; green-yellow              | <a href="http://www.wago.com/2022-104/000-016">www.wago.com/2022-104/000-016</a> |
|    | <b>Nr. articol: 2022-104/000-036</b><br>1-conductor female plug; 2.5 mm <sup>2</sup> ; 4-pole; 2,50 mm <sup>2</sup> ; gray, green-yellow        | <a href="http://www.wago.com/2022-104/000-036">www.wago.com/2022-104/000-036</a> |
|    | <b>Nr. articol: 2022-104/000-037</b><br>1-conductor female plug; 2.5 mm <sup>2</sup> ; 4-pole; 2,50 mm <sup>2</sup> ; green-yellow, gray        | <a href="http://www.wago.com/2022-104/000-037">www.wago.com/2022-104/000-037</a> |
|    | <b>Nr. articol: 2022-104/000-038</b><br>1-conductor female plug; 2.5 mm <sup>2</sup> ; 4-pole; 2,50 mm <sup>2</sup> ; gray, blue, green-yellow  | <a href="http://www.wago.com/2022-104/000-038">www.wago.com/2022-104/000-038</a> |
|    | <b>Nr. articol: 2022-104/000-039</b><br>1-conductor female plug; 2.5 mm <sup>2</sup> ; 4-pole; 2,50 mm <sup>2</sup> ; green-yellow, blue, gray  | <a href="http://www.wago.com/2022-104/000-039">www.wago.com/2022-104/000-039</a> |
|   | <b>Nr. articol: 2022-104/123-000</b><br>1-conductor female plug; Locking lever; 2.5 mm <sup>2</sup> ; 4-pole; 2,50 mm <sup>2</sup> ; gray       | <a href="http://www.wago.com/2022-104/123-000">www.wago.com/2022-104/123-000</a> |
|   | <b>Nr. articol: 2022-104/133-000</b><br>1-conductor female plug; Strain relief plate; 2.5 mm <sup>2</sup> ; 4-pole; 2,50 mm <sup>2</sup> ; gray | <a href="http://www.wago.com/2022-104/133-000">www.wago.com/2022-104/133-000</a> |
|   | <b>Nr. articol: 2022-104/143-000</b><br>1-conductor female plug; Strain relief plate; 2.5 mm <sup>2</sup> ; 4-pole; 2,50 mm <sup>2</sup> ; gray | <a href="http://www.wago.com/2022-104/143-000">www.wago.com/2022-104/143-000</a> |
|  | <b>Nr. articol: 2022-105</b><br>1-conductor female plug; 2.5 mm <sup>2</sup> ; 5-pole; 2,50 mm <sup>2</sup> ; gray                              | <a href="http://www.wago.com/2022-105">www.wago.com/2022-105</a>                 |
|  | <b>Nr. articol: 2022-105/000-006</b><br>1-conductor female plug; 2.5 mm <sup>2</sup> ; 5-pole; 2,50 mm <sup>2</sup> ; blue                      | <a href="http://www.wago.com/2022-105/000-006">www.wago.com/2022-105/000-006</a> |
|  | <b>Nr. articol: 2022-105/000-012</b><br>1-conductor female plug; 2.5 mm <sup>2</sup> ; 5-pole; 2,50 mm <sup>2</sup> ; orange                    | <a href="http://www.wago.com/2022-105/000-012">www.wago.com/2022-105/000-012</a> |
|  | <b>Nr. articol: 2022-105/000-016</b><br>1-conductor female plug; 2.5 mm <sup>2</sup> ; 5-pole; 2,50 mm <sup>2</sup> ; green-yellow              | <a href="http://www.wago.com/2022-105/000-016">www.wago.com/2022-105/000-016</a> |
|  | <b>Nr. articol: 2022-105/000-036</b><br>1-conductor female plug; 2.5 mm <sup>2</sup> ; 5-pole; 2,50 mm <sup>2</sup> ; gray, green-yellow        | <a href="http://www.wago.com/2022-105/000-036">www.wago.com/2022-105/000-036</a> |

Supus modificărilor.

**Nr. articol:** 2022-105/000-0371-conductor female plug; 2.5 mm<sup>2</sup>; 5-pole; 2,50 mm<sup>2</sup>; green-yellow, gray[www.wago.com/2022-105/000-037](http://www.wago.com/2022-105/000-037)**Nr. articol:** 2022-105/000-0381-conductor female plug; 2.5 mm<sup>2</sup>; 5-pole; 2,50 mm<sup>2</sup>; gray, blue, green-yellow[www.wago.com/2022-105/000-038](http://www.wago.com/2022-105/000-038)**Nr. articol:** 2022-105/000-0391-conductor female plug; 2.5 mm<sup>2</sup>; 5-pole; 2,50 mm<sup>2</sup>; green-yellow, blue, gray[www.wago.com/2022-105/000-039](http://www.wago.com/2022-105/000-039)**Nr. articol:** 2022-105/123-0001-conductor female plug; Locking lever; 2.5 mm<sup>2</sup>; 5-pole; 2,50 mm<sup>2</sup>; gray[www.wago.com/2022-105/123-000](http://www.wago.com/2022-105/123-000)**Nr. articol:** 2022-105/134-0001-conductor female plug; Strain relief plate; 2.5 mm<sup>2</sup>; 5-pole; 2,50 mm<sup>2</sup>; gray[www.wago.com/2022-105/134-000](http://www.wago.com/2022-105/134-000)**Nr. articol:** 2022-105/144-0001-conductor female plug; Strain relief plate; 2.5 mm<sup>2</sup>; 5-pole; 2,50 mm<sup>2</sup>; gray[www.wago.com/2022-105/144-000](http://www.wago.com/2022-105/144-000)**Nr. articol:** 2022-1061-conductor female plug; 2.5 mm<sup>2</sup>; 6-pole; 2,50 mm<sup>2</sup>; gray[www.wago.com/2022-106](http://www.wago.com/2022-106)**Nr. articol:** 2022-106/000-0061-conductor female plug; 2.5 mm<sup>2</sup>; 6-pole; 2,50 mm<sup>2</sup>; blue[www.wago.com/2022-106/000-006](http://www.wago.com/2022-106/000-006)**Nr. articol:** 2022-106/000-0121-conductor female plug; 2.5 mm<sup>2</sup>; 6-pole; 2,50 mm<sup>2</sup>; orange[www.wago.com/2022-106/000-012](http://www.wago.com/2022-106/000-012)**Nr. articol:** 2022-106/000-0161-conductor female plug; 2.5 mm<sup>2</sup>; 6-pole; 2,50 mm<sup>2</sup>; green-yellow[www.wago.com/2022-106/000-016](http://www.wago.com/2022-106/000-016)**Nr. articol:** 2022-106/000-0361-conductor female plug; 2.5 mm<sup>2</sup>; 6-pole; 2,50 mm<sup>2</sup>; gray, green-yellow[www.wago.com/2022-106/000-036](http://www.wago.com/2022-106/000-036)**Nr. articol:** 2022-106/000-0371-conductor female plug; 2.5 mm<sup>2</sup>; 6-pole; 2,50 mm<sup>2</sup>; green-yellow, gray[www.wago.com/2022-106/000-037](http://www.wago.com/2022-106/000-037)**Nr. articol:** 2022-106/000-0381-conductor female plug; 2.5 mm<sup>2</sup>; 6-pole; 2,50 mm<sup>2</sup>; gray, blue, green-yellow[www.wago.com/2022-106/000-038](http://www.wago.com/2022-106/000-038)

Supus modificărilor.



**Nr. articol: 2022-106/000-039**

1-conductor female plug; 2.5 mm<sup>2</sup>; 6-pole; 2,50 mm<sup>2</sup>; green-yellow, blue, gray

[www.wago.com/2022-106/000-039](http://www.wago.com/2022-106/000-039)

**Nr. articol: 2022-106/123-000**

1-conductor female plug; Locking lever; 2.5 mm<sup>2</sup>; 6-pole; 2,50 mm<sup>2</sup>; gray

[www.wago.com/2022-106/123-000](http://www.wago.com/2022-106/123-000)

**Nr. articol: 2022-106/134-000**

1-conductor female plug; Strain relief plate; 2.5 mm<sup>2</sup>; 6-pole; 2,50 mm<sup>2</sup>; gray

[www.wago.com/2022-106/134-000](http://www.wago.com/2022-106/134-000)

**Nr. articol: 2022-106/144-000**

1-conductor female plug; Strain relief plate; 2.5 mm<sup>2</sup>; 6-pole; 2,50 mm<sup>2</sup>; gray

[www.wago.com/2022-106/144-000](http://www.wago.com/2022-106/144-000)



**Nr. articol: 2022-107**

1-conductor female plug; 2.5 mm<sup>2</sup>; 7-pole; 2,50 mm<sup>2</sup>; gray

[www.wago.com/2022-107](http://www.wago.com/2022-107)



**Nr. articol: 2022-107/000-006**

1-conductor female plug; 2.5 mm<sup>2</sup>; 7-pole; 2,50 mm<sup>2</sup>; blue

[www.wago.com/2022-107/000-006](http://www.wago.com/2022-107/000-006)



**Nr. articol: 2022-107/000-012**

1-conductor female plug; 2.5 mm<sup>2</sup>; 7-pole; 2,50 mm<sup>2</sup>; orange

[www.wago.com/2022-107/000-012](http://www.wago.com/2022-107/000-012)



**Nr. articol: 2022-107/000-016**

1-conductor female plug; 2.5 mm<sup>2</sup>; 7-pole; 2,50 mm<sup>2</sup>; green-yellow

[www.wago.com/2022-107/000-016](http://www.wago.com/2022-107/000-016)



**Nr. articol: 2022-107/000-036**

1-conductor female plug; 2.5 mm<sup>2</sup>; 7-pole; 2,50 mm<sup>2</sup>; gray, green-yellow

[www.wago.com/2022-107/000-036](http://www.wago.com/2022-107/000-036)



**Nr. articol: 2022-107/000-037**

1-conductor female plug; 2.5 mm<sup>2</sup>; 7-pole; 2,50 mm<sup>2</sup>; green-yellow, gray

[www.wago.com/2022-107/000-037](http://www.wago.com/2022-107/000-037)



**Nr. articol: 2022-107/000-038**

1-conductor female plug; 2.5 mm<sup>2</sup>; 7-pole; 2,50 mm<sup>2</sup>; gray, blue, green-yellow

[www.wago.com/2022-107/000-038](http://www.wago.com/2022-107/000-038)



**Nr. articol: 2022-107/000-039**

1-conductor female plug; 2.5 mm<sup>2</sup>; 7-pole; 2,50 mm<sup>2</sup>; green-yellow, blue, gray









[www.wago.com/2022-107/000-039](http://www.wago.com/2022-107/000-039)

**Nr. articol: 2022-107/123-000**

1-conductor female plug; Locking lever; 2.5 mm<sup>2</sup>; 7-pole; 2,50 mm<sup>2</sup>; gray











[www.wago.com/2022-107/123-000](http://www.wago.com/2022-107/123-000)

Supus modificărilor.











|  |   |  |
|--|---|--|
|  | <b>Nr. articol: 2022-107/135-000</b><br>1-conductor female plug; Strain relief plate; 2.5 mm <sup>2</sup> ; 7-pole; 2,50 mm <sup>2</sup> ; gray | <a href="http://www.wago.com/2022-107/135-000">www.wago.com/2022-107/135-000</a> |
|  | <b>Nr. articol: 2022-107/145-000</b><br>1-conductor female plug; Strain relief plate; 2.5 mm <sup>2</sup> ; 7-pole; 2,50 mm <sup>2</sup> ; gray | <a href="http://www.wago.com/2022-107/145-000">www.wago.com/2022-107/145-000</a> |
|    | <b>Nr. articol: 2022-108</b><br>1-conductor female plug; 2.5 mm <sup>2</sup> ; 8-pole; 2,50 mm <sup>2</sup> ; gray                              | <a href="http://www.wago.com/2022-108">www.wago.com/2022-108</a>                 |
|     | <b>Nr. articol: 2022-108/000-006</b><br>1-conductor female plug; 2.5 mm <sup>2</sup> ; 8-pole; 2,50 mm <sup>2</sup> ; blue                      | <a href="http://www.wago.com/2022-108/000-006">www.wago.com/2022-108/000-006</a> |
|    | <b>Nr. articol: 2022-108/000-012</b><br>1-conductor female plug; 2.5 mm <sup>2</sup> ; 8-pole; 2,50 mm <sup>2</sup> ; orange                    | <a href="http://www.wago.com/2022-108/000-012">www.wago.com/2022-108/000-012</a> |
|     | <b>Nr. articol: 2022-108/000-016</b><br>1-conductor female plug; 2.5 mm <sup>2</sup> ; 8-pole; 2,50 mm <sup>2</sup> ; green-yellow              | <a href="http://www.wago.com/2022-108/000-016">www.wago.com/2022-108/000-016</a> |
|    | <b>Nr. articol: 2022-108/000-036</b><br>1-conductor female plug; 2.5 mm <sup>2</sup> ; 8-pole; 2,50 mm <sup>2</sup> ; gray, green-yellow        | <a href="http://www.wago.com/2022-108/000-036">www.wago.com/2022-108/000-036</a> |
|  | <b>Nr. articol: 2022-108/000-037</b><br>1-conductor female plug; 2.5 mm <sup>2</sup> ; 8-pole; 2,50 mm <sup>2</sup> ; green-yellow, gray        | <a href="http://www.wago.com/2022-108/000-037">www.wago.com/2022-108/000-037</a> |
|  | <b>Nr. articol: 2022-108/000-038</b><br>1-conductor female plug; 2.5 mm <sup>2</sup> ; 8-pole; 2,50 mm <sup>2</sup> ; gray, blue, green-yellow  | <a href="http://www.wago.com/2022-108/000-038">www.wago.com/2022-108/000-038</a> |
|  | <b>Nr. articol: 2022-108/000-039</b><br>1-conductor female plug; 2.5 mm <sup>2</sup> ; 8-pole; 2,50 mm <sup>2</sup> ; green-yellow, blue, gray  | <a href="http://www.wago.com/2022-108/000-039">www.wago.com/2022-108/000-039</a> |
|  | <b>Nr. articol: 2022-108/123-000</b><br>1-conductor female plug; Locking lever; 2.5 mm <sup>2</sup> ; 8-pole; 2,50 mm <sup>2</sup> ; gray       | <a href="http://www.wago.com/2022-108/123-000">www.wago.com/2022-108/123-000</a> |
|  | <b>Nr. articol: 2022-108/135-000</b><br>1-conductor female plug; Strain relief plate; 2.5 mm <sup>2</sup> ; 8-pole; 2,50 mm <sup>2</sup> ; gray | <a href="http://www.wago.com/2022-108/135-000">www.wago.com/2022-108/135-000</a> |
|  | <b>Nr. articol: 2022-108/145-000</b><br>1-conductor female plug; Strain relief plate; 2.5 mm <sup>2</sup> ; 8-pole; 2,50 mm <sup>2</sup> ; gray | <a href="http://www.wago.com/2022-108/145-000">www.wago.com/2022-108/145-000</a> |
|  | <b>Nr. articol: 2022-109</b><br>1-conductor female plug; 2.5 mm <sup>2</sup> ; 9-pole; 2,50 mm <sup>2</sup> ; gray                              | <a href="http://www.wago.com/2022-109">www.wago.com/2022-109</a>                 |

Supus modificărilor.



|  |   |  |
|--|---|--|
|    | <b>Nr. articol:</b> 2022-109/000-006<br>1-conductor female plug; 2.5 mm <sup>2</sup> ; 9-pole; 2,50 mm <sup>2</sup> ; blue                      | <a href="http://www.wago.com/2022-109/000-006">www.wago.com/2022-109/000-006</a> |
|    | <b>Nr. articol:</b> 2022-109/000-012<br>1-conductor female plug; 2.5 mm <sup>2</sup> ; 9-pole; 2,50 mm <sup>2</sup> ; orange                    | <a href="http://www.wago.com/2022-109/000-012">www.wago.com/2022-109/000-012</a> |
|    | <b>Nr. articol:</b> 2022-109/000-016<br>1-conductor female plug; 2.5 mm <sup>2</sup> ; 9-pole; 2,50 mm <sup>2</sup> ; green-yellow              | <a href="http://www.wago.com/2022-109/000-016">www.wago.com/2022-109/000-016</a> |
|    | <b>Nr. articol:</b> 2022-109/000-036<br>1-conductor female plug; 2.5 mm <sup>2</sup> ; 9-pole; 2,50 mm <sup>2</sup> ; gray, green-yellow        | <a href="http://www.wago.com/2022-109/000-036">www.wago.com/2022-109/000-036</a> |
|    | <b>Nr. articol:</b> 2022-109/000-037<br>1-conductor female plug; 2.5 mm <sup>2</sup> ; 9-pole; 2,50 mm <sup>2</sup> ; green-yellow, gray        | <a href="http://www.wago.com/2022-109/000-037">www.wago.com/2022-109/000-037</a> |
|    | <b>Nr. articol:</b> 2022-109/000-038<br>1-conductor female plug; 2.5 mm <sup>2</sup> ; 9-pole; 2,50 mm <sup>2</sup> ; gray, blue, green-yellow  | <a href="http://www.wago.com/2022-109/000-038">www.wago.com/2022-109/000-038</a> |
|   | <b>Nr. articol:</b> 2022-109/000-039<br>1-conductor female plug; 2.5 mm <sup>2</sup> ; 9-pole; 2,50 mm <sup>2</sup> ; green-yellow, blue, gray  | <a href="http://www.wago.com/2022-109/000-039">www.wago.com/2022-109/000-039</a> |
|  | <b>Nr. articol:</b> 2022-109/123-000<br>1-conductor female plug; Locking lever; 2.5 mm <sup>2</sup> ; 9-pole; 2,50 mm <sup>2</sup> ; gray       | <a href="http://www.wago.com/2022-109/123-000">www.wago.com/2022-109/123-000</a> |
|  | <b>Nr. articol:</b> 2022-109/135-000<br>1-conductor female plug; Strain relief plate; 2.5 mm <sup>2</sup> ; 9-pole; 2,50 mm <sup>2</sup> ; gray | <a href="http://www.wago.com/2022-109/135-000">www.wago.com/2022-109/135-000</a> |
|  | <b>Nr. articol:</b> 2022-109/145-000<br>1-conductor female plug; Strain relief plate; 2.5 mm <sup>2</sup> ; 9-pole; 2,50 mm <sup>2</sup> ; gray | <a href="http://www.wago.com/2022-109/145-000">www.wago.com/2022-109/145-000</a> |
|  | <b>Nr. articol:</b> 2022-110<br>1-conductor female plug; 2.5 mm <sup>2</sup> ; 10-pole; 2,50 mm <sup>2</sup> ; gray                             | <a href="http://www.wago.com/2022-110">www.wago.com/2022-110</a>                 |
|  | <b>Nr. articol:</b> 2022-110/000-006<br>1-conductor female plug; 2.5 mm <sup>2</sup> ; 10-pole; 2,50 mm <sup>2</sup> ; blue                     | <a href="http://www.wago.com/2022-110/000-006">www.wago.com/2022-110/000-006</a> |
|  | <b>Nr. articol:</b> 2022-110/000-012<br>1-conductor female plug; 2.5 mm <sup>2</sup> ; 10-pole; 2,50 mm <sup>2</sup> ; orange                   | <a href="http://www.wago.com/2022-110/000-012">www.wago.com/2022-110/000-012</a> |

Supus modificărilor.

|  |  |  |
|--|--|--|
|     | <p><b>Nr. articol: 2022-110/000-016</b><br/>1-conductor female plug; 2.5 mm<sup>2</sup>; 10-pole; 2,50 mm<sup>2</sup>; green-yellow</p>              | <a href="http://www.wago.com/2022-110/000-016">www.wago.com/2022-110/000-016</a> |
|    | <p><b>Nr. articol: 2022-110/000-036</b><br/>1-conductor female plug; 2.5 mm<sup>2</sup>; 10-pole; 2,50 mm<sup>2</sup>; gray, green-yellow</p>        | <a href="http://www.wago.com/2022-110/000-036">www.wago.com/2022-110/000-036</a> |
|    | <p><b>Nr. articol: 2022-110/000-037</b><br/>1-conductor female plug; 2.5 mm<sup>2</sup>; 10-pole; 2,50 mm<sup>2</sup>; green-yellow, gray</p>        | <a href="http://www.wago.com/2022-110/000-037">www.wago.com/2022-110/000-037</a> |
|    | <p><b>Nr. articol: 2022-110/000-038</b><br/>1-conductor female plug; 2.5 mm<sup>2</sup>; 10-pole; 2,50 mm<sup>2</sup>; gray, blue, green-yellow</p>  | <a href="http://www.wago.com/2022-110/000-038">www.wago.com/2022-110/000-038</a> |
|    | <p><b>Nr. articol: 2022-110/000-039</b><br/>1-conductor female plug; 2.5 mm<sup>2</sup>; 10-pole; 2,50 mm<sup>2</sup>; green-yellow, blue, gray</p>  | <a href="http://www.wago.com/2022-110/000-039">www.wago.com/2022-110/000-039</a> |
|  | <p><b>Nr. articol: 2022-110/123-000</b><br/>1-conductor female plug; Locking lever; 2.5 mm<sup>2</sup>; 10-pole; 2,50 mm<sup>2</sup>; gray</p>       | <a href="http://www.wago.com/2022-110/123-000">www.wago.com/2022-110/123-000</a> |
|  | <p><b>Nr. articol: 2022-110/135-000</b><br/>1-conductor female plug; Strain relief plate; 2.5 mm<sup>2</sup>; 10-pole; 2,50 mm<sup>2</sup>; gray</p> | <a href="http://www.wago.com/2022-110/135-000">www.wago.com/2022-110/135-000</a> |
|  | <p><b>Nr. articol: 2022-110/145-000</b><br/>1-conductor female plug; Strain relief plate; 2.5 mm<sup>2</sup>; 10-pole; 2,50 mm<sup>2</sup>; gray</p> | <a href="http://www.wago.com/2022-110/145-000">www.wago.com/2022-110/145-000</a> |
|  | <p><b>Nr. articol: 2022-111</b><br/>1-conductor female plug; 2.5 mm<sup>2</sup>; 11-pole; 2,50 mm<sup>2</sup>; gray</p>                              | <a href="http://www.wago.com/2022-111">www.wago.com/2022-111</a>                 |
|   | <p><b>Nr. articol: 2022-111/000-006</b><br/>1-conductor female plug; 2.5 mm<sup>2</sup>; 11-pole; 2,50 mm<sup>2</sup>; blue</p>                      | <a href="http://www.wago.com/2022-111/000-006">www.wago.com/2022-111/000-006</a> |
|  | <p><b>Nr. articol: 2022-111/000-012</b><br/>1-conductor female plug; 2.5 mm<sup>2</sup>; 11-pole; 2,50 mm<sup>2</sup>; orange</p>                    | <a href="http://www.wago.com/2022-111/000-012">www.wago.com/2022-111/000-012</a> |
|   | <p><b>Nr. articol: 2022-111/000-016</b><br/>1-conductor female plug; 2.5 mm<sup>2</sup>; 11-pole; 2,50 mm<sup>2</sup>; green-yellow</p>              | <a href="http://www.wago.com/2022-111/000-016">www.wago.com/2022-111/000-016</a> |
|  | <p><b>Nr. articol: 2022-111/000-036</b><br/>1-conductor female plug; 2.5 mm<sup>2</sup>; 11-pole; 2,50 mm<sup>2</sup>; gray, green-yellow</p>        | <a href="http://www.wago.com/2022-111/000-036">www.wago.com/2022-111/000-036</a> |

Supus modificărilor.



**Nr. articol:** 2022-111/000-037

1-conductor female plug; 2.5 mm<sup>2</sup>; 11-pole; 2,50 mm<sup>2</sup>; green-yellow, gray

[www.wago.com/2022-111/000-037](http://www.wago.com/2022-111/000-037)



**Nr. articol:** 2022-111/000-038

1-conductor female plug; 2.5 mm<sup>2</sup>; 11-pole; 2,50 mm<sup>2</sup>; gray, blue, green-yellow

[www.wago.com/2022-111/000-038](http://www.wago.com/2022-111/000-038)



**Nr. articol:** 2022-111/000-039

1-conductor female plug; 2.5 mm<sup>2</sup>; 11-pole; 2,50 mm<sup>2</sup>; green-yellow, blue, gray

[www.wago.com/2022-111/000-039](http://www.wago.com/2022-111/000-039)

**Nr. articol:** 2022-111/126-000

1-conductor female plug; Locking lever; 2.5 mm<sup>2</sup>; 11-pole; 2,50 mm<sup>2</sup>; gray

[www.wago.com/2022-111/126-000](http://www.wago.com/2022-111/126-000)

**Nr. articol:** 2022-111/136-000

1-conductor female plug; Strain relief plate; 2.5 mm<sup>2</sup>; 11-pole; 2,50 mm<sup>2</sup>; gray

[www.wago.com/2022-111/136-000](http://www.wago.com/2022-111/136-000)

**Nr. articol:** 2022-111/146-000

1-conductor female plug; Strain relief plate; 2.5 mm<sup>2</sup>; 11-pole; 2,50 mm<sup>2</sup>; gray

[www.wago.com/2022-111/146-000](http://www.wago.com/2022-111/146-000)



**Nr. articol:** 2022-112

1-conductor female plug; 2.5 mm<sup>2</sup>; 12-pole; 2,50 mm<sup>2</sup>; gray

[www.wago.com/2022-112](http://www.wago.com/2022-112)



**Nr. articol:** 2022-112/000-006

1-conductor female plug; 2.5 mm<sup>2</sup>; 12-pole; 2,50 mm<sup>2</sup>; blue

[www.wago.com/2022-112/000-006](http://www.wago.com/2022-112/000-006)



**Nr. articol:** 2022-112/000-012

1-conductor female plug; 2.5 mm<sup>2</sup>; 12-pole; 2,50 mm<sup>2</sup>; orange

[www.wago.com/2022-112/000-012](http://www.wago.com/2022-112/000-012)



**Nr. articol:** 2022-112/000-016

1-conductor female plug; 2.5 mm<sup>2</sup>; 12-pole; 2,50 mm<sup>2</sup>; green-yellow

[www.wago.com/2022-112/000-016](http://www.wago.com/2022-112/000-016)



**Nr. articol:** 2022-112/000-036

1-conductor female plug; 2.5 mm<sup>2</sup>; 12-pole; 2,50 mm<sup>2</sup>; gray, green-yellow

[www.wago.com/2022-112/000-036](http://www.wago.com/2022-112/000-036)



**Nr. articol:** 2022-112/000-037

1-conductor female plug; 2.5 mm<sup>2</sup>; 12-pole; 2,50 mm<sup>2</sup>; green-yellow, gray

[www.wago.com/2022-112/000-037](http://www.wago.com/2022-112/000-037)



**Nr. articol:** 2022-112/000-038

1-conductor female plug; 2.5 mm<sup>2</sup>; 12-pole; 2,50 mm<sup>2</sup>; gray, blue, green-yellow

[www.wago.com/2022-112/000-038](http://www.wago.com/2022-112/000-038)

Supus modificărilor.



**Nr. articol:** 2022-112/000-039

1-conductor female plug; 2.5 mm<sup>2</sup>; 12-pole; 2,50 mm<sup>2</sup>; green-yellow, blue, gray

[www.wago.com/2022-112/000-039](http://www.wago.com/2022-112/000-039)

**Nr. articol:** 2022-112/126-000

1-conductor female plug; Locking lever; 2.5 mm<sup>2</sup>; 12-pole; 2,50 mm<sup>2</sup>; gray

[www.wago.com/2022-112/126-000](http://www.wago.com/2022-112/126-000)

**Nr. articol:** 2022-112/136-000

1-conductor female plug; Strain relief plate; 2.5 mm<sup>2</sup>; 12-pole; 2,50 mm<sup>2</sup>; gray

[www.wago.com/2022-112/136-000](http://www.wago.com/2022-112/136-000)

**Nr. articol:** 2022-112/146-000

1-conductor female plug; Strain relief plate; 2.5 mm<sup>2</sup>; 12-pole; 2,50 mm<sup>2</sup>; gray

[www.wago.com/2022-112/146-000](http://www.wago.com/2022-112/146-000)



**Nr. articol:** 2022-113

1-conductor female plug; 2.5 mm<sup>2</sup>; 13-pole; 2,50 mm<sup>2</sup>; gray

[www.wago.com/2022-113](http://www.wago.com/2022-113)



**Nr. articol:** 2022-113/000-006

1-conductor female plug; 2.5 mm<sup>2</sup>; 13-pole; 2,50 mm<sup>2</sup>; blue

[www.wago.com/2022-113/000-006](http://www.wago.com/2022-113/000-006)



**Nr. articol:** 2022-113/000-012

1-conductor female plug; 2.5 mm<sup>2</sup>; 13-pole; 2,50 mm<sup>2</sup>; orange

[www.wago.com/2022-113/000-012](http://www.wago.com/2022-113/000-012)



**Nr. articol:** 2022-113/000-016

1-conductor female plug; 2.5 mm<sup>2</sup>; 13-pole; 2,50 mm<sup>2</sup>; green-yellow

[www.wago.com/2022-113/000-016](http://www.wago.com/2022-113/000-016)



**Nr. articol:** 2022-113/000-036

1-conductor female plug; 2.5 mm<sup>2</sup>; 13-pole; 2,50 mm<sup>2</sup>; gray, green-yellow

[www.wago.com/2022-113/000-036](http://www.wago.com/2022-113/000-036)



**Nr. articol:** 2022-113/000-037

1-conductor female plug; 2.5 mm<sup>2</sup>; 13-pole; 2,50 mm<sup>2</sup>; green-yellow, gray

[www.wago.com/2022-113/000-037](http://www.wago.com/2022-113/000-037)



**Nr. articol:** 2022-113/000-038

1-conductor female plug; 2.5 mm<sup>2</sup>; 13-pole; 2,50 mm<sup>2</sup>; gray, blue, green-yellow

[www.wago.com/2022-113/000-038](http://www.wago.com/2022-113/000-038)



**Nr. articol:** 2022-113/000-039

1-conductor female plug; 2.5 mm<sup>2</sup>; 13-pole; 2,50 mm<sup>2</sup>; green-yellow, blue, gray









[www.wago.com/2022-113/000-039](http://www.wago.com/2022-113/000-039)

**Nr. articol:** 2022-113/126-000











1-conductor female plug; Locking lever; 2.5 mm<sup>2</sup>; 13-pole; 2,50 mm<sup>2</sup>; gray

[www.wago.com/2022-113/126-000](http://www.wago.com/2022-113/126-000)

















Supus modificărilor.

|  |  |  |
|--|--|--|
|  | <b>Nr. articol: 2022-113/136-000</b><br>1-conductor female plug; Strain relief plate; 2.5 mm <sup>2</sup> ; 13-pole; 2,50 mm <sup>2</sup> ; gray | <a href="http://www.wago.com/2022-113/136-000">www.wago.com/2022-113/136-000</a> |
|  | <b>Nr. articol: 2022-113/146-000</b><br>1-conductor female plug; Strain relief plate; 2.5 mm <sup>2</sup> ; 13-pole; 2,50 mm <sup>2</sup> ; gray | <a href="http://www.wago.com/2022-113/146-000">www.wago.com/2022-113/146-000</a> |
|    | <b>Nr. articol: 2022-114</b><br>1-conductor female plug; 2.5 mm <sup>2</sup> ; 14-pole; 2,50 mm <sup>2</sup> ; gray                              | <a href="http://www.wago.com/2022-114">www.wago.com/2022-114</a>                 |
|    | <b>Nr. articol: 2022-114/000-006</b><br>1-conductor female plug; 2.5 mm <sup>2</sup> ; 14-pole; 2,50 mm <sup>2</sup> ; blue                      | <a href="http://www.wago.com/2022-114/000-006">www.wago.com/2022-114/000-006</a> |
|    | <b>Nr. articol: 2022-114/000-012</b><br>1-conductor female plug; 2.5 mm <sup>2</sup> ; 14-pole; 2,50 mm <sup>2</sup> ; orange                    | <a href="http://www.wago.com/2022-114/000-012">www.wago.com/2022-114/000-012</a> |
|    | <b>Nr. articol: 2022-114/000-016</b><br>1-conductor female plug; 2.5 mm <sup>2</sup> ; 14-pole; 2,50 mm <sup>2</sup> ; green-yellow              | <a href="http://www.wago.com/2022-114/000-016">www.wago.com/2022-114/000-016</a> |
|    | <b>Nr. articol: 2022-114/000-036</b><br>1-conductor female plug; 2.5 mm <sup>2</sup> ; 14-pole; 2,50 mm <sup>2</sup> ; gray, green-yellow        | <a href="http://www.wago.com/2022-114/000-036">www.wago.com/2022-114/000-036</a> |
|  | <b>Nr. articol: 2022-114/000-037</b><br>1-conductor female plug; 2.5 mm <sup>2</sup> ; 14-pole; 2,50 mm <sup>2</sup> ; green-yellow, gray        | <a href="http://www.wago.com/2022-114/000-037">www.wago.com/2022-114/000-037</a> |
|  | <b>Nr. articol: 2022-114/000-038</b><br>1-conductor female plug; 2.5 mm <sup>2</sup> ; 14-pole; 2,50 mm <sup>2</sup> ; gray, blue, green-yellow  | <a href="http://www.wago.com/2022-114/000-038">www.wago.com/2022-114/000-038</a> |
|  | <b>Nr. articol: 2022-114/000-039</b><br>1-conductor female plug; 2.5 mm <sup>2</sup> ; 14-pole; 2,50 mm <sup>2</sup> ; green-yellow, blue, gray  | <a href="http://www.wago.com/2022-114/000-039">www.wago.com/2022-114/000-039</a> |
|  | <b>Nr. articol: 2022-114/126-000</b><br>1-conductor female plug; Locking lever; 2.5 mm <sup>2</sup> ; 14-pole; 2,50 mm <sup>2</sup> ; gray       | <a href="http://www.wago.com/2022-114/126-000">www.wago.com/2022-114/126-000</a> |
|  | <b>Nr. articol: 2022-114/136-000</b><br>1-conductor female plug; Strain relief plate; 2.5 mm <sup>2</sup> ; 14-pole; 2,50 mm <sup>2</sup> ; gray | <a href="http://www.wago.com/2022-114/136-000">www.wago.com/2022-114/136-000</a> |
|  | <b>Nr. articol: 2022-114/146-000</b><br>1-conductor female plug; Strain relief plate; 2.5 mm <sup>2</sup> ; 14-pole; 2,50 mm <sup>2</sup> ; gray | <a href="http://www.wago.com/2022-114/146-000">www.wago.com/2022-114/146-000</a> |
|  | <b>Nr. articol: 2022-115</b><br>1-conductor female plug; 2.5 mm <sup>2</sup> ; 15-pole; 2,50 mm <sup>2</sup> ; gray                              | <a href="http://www.wago.com/2022-115">www.wago.com/2022-115</a>                 |

Supus modificărilor.

|  |  |  |
|--|--|--|
|    | <b>Nr. articol:</b> 2022-115/000-006<br>1-conductor female plug; 2.5 mm <sup>2</sup> ; 15-pole; 2,50 mm <sup>2</sup> ; blue                      | <a href="http://www.wago.com/2022-115/000-006">www.wago.com/2022-115/000-006</a> |
|    | <b>Nr. articol:</b> 2022-115/000-012<br>1-conductor female plug; 2.5 mm <sup>2</sup> ; 15-pole; 2,50 mm <sup>2</sup> ; orange                    | <a href="http://www.wago.com/2022-115/000-012">www.wago.com/2022-115/000-012</a> |
|    | <b>Nr. articol:</b> 2022-115/000-016<br>1-conductor female plug; 2.5 mm <sup>2</sup> ; 15-pole; 2,50 mm <sup>2</sup> ; green-yellow              | <a href="http://www.wago.com/2022-115/000-016">www.wago.com/2022-115/000-016</a> |
|    | <b>Nr. articol:</b> 2022-115/000-036<br>1-conductor female plug; 2.5 mm <sup>2</sup> ; 15-pole; 2,50 mm <sup>2</sup> ; gray, green-yellow        | <a href="http://www.wago.com/2022-115/000-036">www.wago.com/2022-115/000-036</a> |
|    | <b>Nr. articol:</b> 2022-115/000-037<br>1-conductor female plug; 2.5 mm <sup>2</sup> ; 15-pole; 2,50 mm <sup>2</sup> ; green-yellow, gray        | <a href="http://www.wago.com/2022-115/000-037">www.wago.com/2022-115/000-037</a> |
|    | <b>Nr. articol:</b> 2022-115/000-038<br>1-conductor female plug; 2.5 mm <sup>2</sup> ; 15-pole; 2,50 mm <sup>2</sup> ; gray, blue, green-yellow  | <a href="http://www.wago.com/2022-115/000-038">www.wago.com/2022-115/000-038</a> |
|    | <b>Nr. articol:</b> 2022-115/000-039<br>1-conductor female plug; 2.5 mm <sup>2</sup> ; 15-pole; 2,50 mm <sup>2</sup> ; green-yellow, blue, gray  | <a href="http://www.wago.com/2022-115/000-039">www.wago.com/2022-115/000-039</a> |
|  | <b>Nr. articol:</b> 2022-115/127-000<br>1-conductor female plug; Locking lever; 2.5 mm <sup>2</sup> ; 15-pole; 2,50 mm <sup>2</sup> ; gray       | <a href="http://www.wago.com/2022-115/127-000">www.wago.com/2022-115/127-000</a> |
|  | <b>Nr. articol:</b> 2022-115/137-000<br>1-conductor female plug; Strain relief plate; 2.5 mm <sup>2</sup> ; 15-pole; 2,50 mm <sup>2</sup> ; gray | <a href="http://www.wago.com/2022-115/137-000">www.wago.com/2022-115/137-000</a> |
|  | <b>Nr. articol:</b> 2022-115/147-000<br>1-conductor female plug; Strain relief plate; 2.5 mm <sup>2</sup> ; 15-pole; 2,50 mm <sup>2</sup> ; gray | <a href="http://www.wago.com/2022-115/147-000">www.wago.com/2022-115/147-000</a> |
| <b>check</b>   |  |  |
|  | <b>Nr. articol:</b> 2002-511<br>Modular TOPJOB®S connector; modular; for jumper contact slot; 1-pole; 2,50 mm <sup>2</sup> ; gray                | <a href="http://www.wago.com/2002-511">www.wago.com/2002-511</a>                 |
|  | <b>Nr. articol:</b> 2002-549<br>Spacer module; modular; e.g., for bridging commoned terminal blocks; gray  | <a href="http://www.wago.com/2002-549">www.wago.com/2002-549</a>                 |
|  | <b>Nr. articol:</b> 2002-552<br>Modular TOPJOB®S connector; modular; for jumper contact slot; 2-pole; 2,50 mm <sup>2</sup> ; gray                | <a href="http://www.wago.com/2002-552">www.wago.com/2002-552</a>                 |
|  | <b>Nr. articol:</b> 2002-553<br>Modular TOPJOB®S connector; modular; for jumper contact slot; 3-pole; 2,50 mm <sup>2</sup> ; gray                | <a href="http://www.wago.com/2002-553">www.wago.com/2002-553</a>                 |

Supus modificărilor.

|  |  |  |
|--|--|--|
|    | <b>Nr. articol: 2002-554</b><br>Modular TOPJOB®S connector; modular; for jumper contact slot; 4-pole; 2,50 mm <sup>2</sup> ; gray              | <a href="http://www.wago.com/2002-554">www.wago.com/2002-554</a>                 |
|    | <b>Nr. articol: 2002-555</b><br>Modular TOPJOB®S connector; modular; for jumper contact slot; 5-pole; 2,50 mm <sup>2</sup> ; gray              | <a href="http://www.wago.com/2002-555">www.wago.com/2002-555</a>                 |
|    | <b>Nr. articol: 2002-556</b><br>Modular TOPJOB®S connector; modular; for jumper contact slot; 6-pole; 2,50 mm <sup>2</sup> ; gray              | <a href="http://www.wago.com/2002-556">www.wago.com/2002-556</a>                 |
|    | <b>Nr. articol: 2002-557</b><br>Modular TOPJOB®S connector; modular; for jumper contact slot; 7-pole; 2,50 mm <sup>2</sup> ; gray              | <a href="http://www.wago.com/2002-557">www.wago.com/2002-557</a>                 |
|    | <b>Nr. articol: 2002-558</b><br>Modular TOPJOB®S connector; modular; for jumper contact slot; 8-pole; 2,50 mm <sup>2</sup> ; gray              | <a href="http://www.wago.com/2002-558">www.wago.com/2002-558</a>                 |
|    | <b>Nr. articol: 2002-559</b><br>Modular TOPJOB®S connector; modular; for jumper contact slot; 9-pole; 2,50 mm <sup>2</sup> ; gray              | <a href="http://www.wago.com/2002-559">www.wago.com/2002-559</a>                 |
|    | <b>Nr. articol: 2002-560</b><br>Modular TOPJOB®S connector; modular; for jumper contact slot; 10-pole; 2,50 mm <sup>2</sup> ; gray             | <a href="http://www.wago.com/2002-560">www.wago.com/2002-560</a>                 |
|    | <b>Nr. articol: 2009-174</b><br>Test plug adapter; for 4 mm Ø test plugs; for testing TOPJOB®S rail-mounted terminal blocks; gray              | <a href="http://www.wago.com/2009-174">www.wago.com/2009-174</a>                 |
|    | <b>Nr. articol: 2009-182</b><br>Testing tap; for max. 2.5 mm <sup>2</sup> ; tool-free connection for individual test wires 0.08 - 2.5 mm; gray | <a href="http://www.wago.com/2009-182">www.wago.com/2009-182</a>                 |
|   | <b>Nr. articol: 859-500</b><br>Test pin; 1 mm Ø; with solder connection for test wire  | <a href="http://www.wago.com/859-500">www.wago.com/859-500</a>                   |
| <b>Jumper</b>  |  |  |
|  | <b>Nr. articol: 2002-400</b><br>Adjacent jumper for continuous commoning; insulated; 2-way; Nominal current 25 A; light gray                   | <a href="http://www.wago.com/2002-400">www.wago.com/2002-400</a>                 |
|  | <b>Nr. articol: 2002-402</b><br>Push-in type jumper bar; insulated; 2-way; Nominal current 25 A; light gray                                    | <a href="http://www.wago.com/2002-402">www.wago.com/2002-402</a>                 |
|  | <b>Nr. articol: 2002-402/000-005</b><br>Push-in type jumper bar; insulated; 2-way; Nominal current 25 A; red                                   | <a href="http://www.wago.com/2002-402/000-005">www.wago.com/2002-402/000-005</a> |
|  | <b>Nr. articol: 2002-402/000-006</b><br>Push-in type jumper bar; insulated; 2-way; Nominal current 25 A; blue                                  | <a href="http://www.wago.com/2002-402/000-006">www.wago.com/2002-402/000-006</a> |
|  | <b>Nr. articol: 2002-403</b><br>Push-in type jumper bar; insulated; 3-way; Nominal current 25 A; light gray                                    | <a href="http://www.wago.com/2002-403">www.wago.com/2002-403</a>                 |
|  | <b>Nr. articol: 2002-403/000-005</b><br>Push-in type jumper bar; insulated; 3-way; Nominal current 25 A; red                                   | <a href="http://www.wago.com/2002-403/000-005">www.wago.com/2002-403/000-005</a> |

Supus modificărilor.

**Nr. articol:** 2002-403/000-006

Push-in type jumper bar; insulated; 3-way; Nominal current 25 A; blue

[www.wago.com/2002-403/000-006](http://www.wago.com/2002-403/000-006)**Nr. articol:** 2002-404

Push-in type jumper bar; insulated; 4-way; Nominal current 25 A; light gray

[www.wago.com/2002-404](http://www.wago.com/2002-404)**Nr. articol:** 2002-404/000-005

Push-in type jumper bar; insulated; 4-way; Nominal current 25 A; red

[www.wago.com/2002-404/000-005](http://www.wago.com/2002-404/000-005)**Nr. articol:** 2002-404/000-006

Push-in type jumper bar; insulated; 4-way; Nominal current 25 A; blue

[www.wago.com/2002-404/000-006](http://www.wago.com/2002-404/000-006)**Nr. articol:** 2002-405

Push-in type jumper bar; insulated; 5-way; Nominal current 25 A; light gray

[www.wago.com/2002-405](http://www.wago.com/2002-405)**Nr. articol:** 2002-405/000-005

Push-in type jumper bar; insulated; 5-way; Nominal current 25 A; red

[www.wago.com/2002-405/000-005](http://www.wago.com/2002-405/000-005)**Nr. articol:** 2002-405/000-006

Push-in type jumper bar; insulated; 5-way; Nominal current 25 A; blue

[www.wago.com/2002-405/000-006](http://www.wago.com/2002-405/000-006)**Nr. articol:** 2002-405/011-000

Star point jumper; insulated; 3-way (1-3-5); IN = IN terminal block; light gray

[www.wago.com/2002-405/011-000](http://www.wago.com/2002-405/011-000)**Nr. articol:** 2002-406

Push-in type jumper bar; insulated; 6-way; Nominal current 25 A; light gray

[www.wago.com/2002-406](http://www.wago.com/2002-406)**Nr. articol:** 2002-406/000-005

Push-in type jumper bar; insulated; 6-way; Nominal current 25 A; red

[www.wago.com/2002-406/000-005](http://www.wago.com/2002-406/000-005)**Nr. articol:** 2002-406/000-006

Push-in type jumper bar; insulated; 6-way; Nominal current 25 A; blue

[www.wago.com/2002-406/000-006](http://www.wago.com/2002-406/000-006)**Nr. articol:** 2002-406/020-000

Delta jumper; insulated; 1-2 3-4 5-6; IN = IN terminal block; light gray

[www.wago.com/2002-406/020-000](http://www.wago.com/2002-406/020-000)**Nr. articol:** 2002-407

Push-in type jumper bar; insulated; 7-way; Nominal current 25 A; light gray

[www.wago.com/2002-407](http://www.wago.com/2002-407)**Nr. articol:** 2002-407/000-005

Push-in type jumper bar; insulated; 7-way; Nominal current 25 A; red















[www.wago.com/2002-407/000-005](http://www.wago.com/2002-407/000-005)

Supus modificărilor.

WAGO Kontakttechnik GmbH & Co. KG  
 /Representative Office Romania  
 Sos. Pipera-Tunari nr. 1/1  
 building 1, 2nd floor | 077190 Voluntari, Ilfov  
 Tel.: +40-(0)31 421 85 68 | Email: info-RO@wago.com

Aveți întrebări despre produsele noastre?  
 Vă stăm la dispoziție pentru preluarea apelului la +40 (0) 31 421 85 68.



|  |  |  |
|--|--|--|
|    | <b>Nr. articol:</b> 2002-407/000-006<br>Push-in type jumper bar; insulated; 7-way; Nominal current 25 A; blue                        | <a href="http://www.wago.com/2002-407/000-006">www.wago.com/2002-407/000-006</a> |
|    | <b>Nr. articol:</b> 2002-408<br>Push-in type jumper bar; insulated; 8-way; Nominal current 25 A; light gray                          | <a href="http://www.wago.com/2002-408">www.wago.com/2002-408</a>                 |
|    | <b>Nr. articol:</b> 2002-408/000-005<br>Push-in type jumper bar; insulated; 8-way; Nominal current 25 A; red                         | <a href="http://www.wago.com/2002-408/000-005">www.wago.com/2002-408/000-005</a> |
|    | <b>Nr. articol:</b> 2002-408/000-006<br>Push-in type jumper bar; insulated; 8-way; Nominal current 25 A; blue                        | <a href="http://www.wago.com/2002-408/000-006">www.wago.com/2002-408/000-006</a> |
|    | <b>Nr. articol:</b> 2002-409<br>Push-in type jumper bar; insulated; 9-way; Nominal current 25 A; light gray                          | <a href="http://www.wago.com/2002-409">www.wago.com/2002-409</a>                 |
|    | <b>Nr. articol:</b> 2002-409/000-005<br>Push-in type jumper bar; insulated; 9-way; Nominal current 25 A; red                         | <a href="http://www.wago.com/2002-409/000-005">www.wago.com/2002-409/000-005</a> |
|    | <b>Nr. articol:</b> 2002-409/000-006<br>Push-in type jumper bar; insulated; 9-way; Nominal current 25 A; blue                        | <a href="http://www.wago.com/2002-409/000-006">www.wago.com/2002-409/000-006</a> |
|   | <b>Nr. articol:</b> 2002-410<br>Push-in type jumper bar; insulated; 10-way; Nominal current 25 A; light gray                         | <a href="http://www.wago.com/2002-410">www.wago.com/2002-410</a>                 |
|  | <b>Nr. articol:</b> 2002-410/000-005<br>Push-in type jumper bar; insulated; 10-way; Nominal current 25 A; red                        | <a href="http://www.wago.com/2002-410/000-005">www.wago.com/2002-410/000-005</a> |
|  | <b>Nr. articol:</b> 2002-410/000-006<br>Push-in type jumper bar; insulated; 10-way; Nominal current 25 A; blue                       | <a href="http://www.wago.com/2002-410/000-006">www.wago.com/2002-410/000-006</a> |
|  | <b>Nr. articol:</b> 2002-423<br>Adjacent jumper for continuous commoning; insulated; from 1 to 3; Nominal current 25 A; light gray   | <a href="http://www.wago.com/2002-423">www.wago.com/2002-423</a>                 |
|  | <b>Nr. articol:</b> 2002-423/000-005<br>Adjacent jumper for continuous commoning; insulated; from 1 to 3; Nominal current 25 A; red  | <a href="http://www.wago.com/2002-423/000-005">www.wago.com/2002-423/000-005</a> |
|  | <b>Nr. articol:</b> 2002-423/000-006<br>Adjacent jumper for continuous commoning; insulated; from 1 to 3; Nominal current 25 A; blue | <a href="http://www.wago.com/2002-423/000-006">www.wago.com/2002-423/000-006</a> |
|  | <b>Nr. articol:</b> 2002-433<br>Push-in type jumper bar; insulated; from 1 to 3; Nominal current 25 A; light gray                    | <a href="http://www.wago.com/2002-433">www.wago.com/2002-433</a>                 |
|  | <b>Nr. articol:</b> 2002-434<br>Push-in type jumper bar; insulated; from 1 to 4; Nominal current 25 A; light gray                    | <a href="http://www.wago.com/2002-434">www.wago.com/2002-434</a>                 |





Supus modificărilor.

|  |  |  |
|--|--|--|
|    | <b>Nr. articol: 2002-435</b><br>Push-in type jumper bar; insulated; from 1 to 5; Nominal current 25 A; light gray  | <a href="http://www.wago.com/2002-435">www.wago.com/2002-435</a>                 |
|    | <b>Nr. articol: 2002-436</b><br>Push-in type jumper bar; insulated; from 1 to 6; Nominal current 25 A; light gray  | <a href="http://www.wago.com/2002-436">www.wago.com/2002-436</a>                 |
|    | <b>Nr. articol: 2002-437</b><br>Push-in type jumper bar; insulated; from 1 to 7; Nominal current 25 A; light gray  | <a href="http://www.wago.com/2002-437">www.wago.com/2002-437</a>                 |
|    | <b>Nr. articol: 2002-438</b><br>Push-in type jumper bar; insulated; from 1 to 8; Nominal current 25 A; light gray  | <a href="http://www.wago.com/2002-438">www.wago.com/2002-438</a>                 |
|    | <b>Nr. articol: 2002-439</b><br>Push-in type jumper bar; insulated; from 1 to 9; Nominal current 25 A; light gray  | <a href="http://www.wago.com/2002-439">www.wago.com/2002-439</a>                 |
|    | <b>Nr. articol: 2002-440</b><br>Push-in type jumper bar; insulated; from 1 to 10; Nominal current 25 A; light gray   | <a href="http://www.wago.com/2002-440">www.wago.com/2002-440</a>                 |
|    | <b>Nr. articol: 2002-472</b><br>Staggered jumper; insulated; 2-way; Nominal current 25 A; suitable for 2002 and 2003 Series rail-mounted terminal blocks; light gray                             | <a href="http://www.wago.com/2002-472">www.wago.com/2002-472</a>                 |
|    | <b>Nr. articol: 2002-473</b><br>Staggered jumper; insulated; 3-way; Nominal current 25 A; suitable for 2002 and 2003 Series rail-mounted terminal blocks; light gray                             | <a href="http://www.wago.com/2002-473">www.wago.com/2002-473</a>                 |
|  | <b>Nr. articol: 2002-473/011-000</b><br>Ready-made staggered jumper; insulated; 2-way (1-3); Nominal current 25 A; with contact lugs broken off at the factory and circuit marking; light gray   | <a href="http://www.wago.com/2002-473/011-000">www.wago.com/2002-473/011-000</a> |
|  | <b>Nr. articol: 2002-474</b><br>Staggered jumper; insulated; 4-way; Nominal current 25 A; suitable for 2002 and 2003 Series rail-mounted terminal blocks; light gray                             | <a href="http://www.wago.com/2002-474">www.wago.com/2002-474</a>                 |
|  | <b>Nr. articol: 2002-475</b><br>Staggered jumper; insulated; 5-way; Nominal current 25 A; suitable for 2002 and 2003 Series rail-mounted terminal blocks; light gray                             | <a href="http://www.wago.com/2002-475">www.wago.com/2002-475</a>                 |
|  | <b>Nr. articol: 2002-475/011-000</b><br>Ready-made staggered jumper; insulated; 3-way (1-3-5); Nominal current 25 A; with contact lugs broken off at the factory and circuit marking; light gray | <a href="http://www.wago.com/2002-475/011-000">www.wago.com/2002-475/011-000</a> |
|  | <b>Nr. articol: 2002-476</b><br>Staggered jumper; insulated; 6-way; Nominal current 25 A; suitable for 2002 and 2003 Series rail-mounted terminal blocks; light gray                             | <a href="http://www.wago.com/2002-476">www.wago.com/2002-476</a>                 |
|  | <b>Nr. articol: 2002-477</b><br>Staggered jumper; insulated; 7-way; Nominal current 25 A; suitable for 2002 and 2003 Series rail-mounted terminal blocks; light gray                             | <a href="http://www.wago.com/2002-477">www.wago.com/2002-477</a>                 |
|  | <b>Nr. articol: 2002-477/011-000</b><br>Ready-made staggered jumper; insulated; 1-3-5-7; Nominal current 25 A; with contact lugs broken off at the factory and circuit marking; light gray       | <a href="http://www.wago.com/2002-477/011-000">www.wago.com/2002-477/011-000</a> |
|  | <b>Nr. articol: 2002-478</b><br>Staggered jumper; insulated; 8-way; Nominal current 25 A; suitable for 2002 and 2003 Series rail-mounted terminal blocks; light gray                             | <a href="http://www.wago.com/2002-478">www.wago.com/2002-478</a>                 |

Supus modificărilor.

WAGO Kontakttechnik GmbH & Co. KG  
/Representative Office Romania  
Sos. Pipera-Tunari nr. 1/1  
building 1, 2nd floor | 077190 Voluntari, Ilfov  
Tel.: +40-(0)31 421 85 68 | Email: info-RO@wago.com

Aveți întrebări despre produsele noastre?  
Vă stăm la dispoziție pentru preluarea apelului la +40 (0) 31 421 85 68.

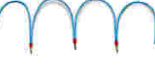
|   |   |  |
|---|---|--|
|   | <b>Nr. articol: 2002-479</b><br>Staggered jumper; insulated; 9-way; Nominal current 25 A; suitable for 2002 and 2003 Series rail-mounted terminal blocks; light gray                            | <a href="http://www.wago.com/2002-479">www.wago.com/2002-479</a>                 |
|   | <b>Nr. articol: 2002-479/011-000</b><br>Ready-made staggered jumper; insulated; 1-3-5-7-9; Nominal current 25 A; with contact lugs broken off at the factory and circuit marking; light gray    | <a href="http://www.wago.com/2002-479/011-000">www.wago.com/2002-479/011-000</a> |
|   | <b>Nr. articol: 2002-480</b><br>Staggered jumper; insulated; 10-way; Nominal current 25 A; suitable for 2002 and 2003 Series rail-mounted terminal blocks; light gray                           | <a href="http://www.wago.com/2002-480">www.wago.com/2002-480</a>                 |
|   | <b>Nr. articol: 2002-481</b><br>Staggered jumper; insulated; 11-way; Nominal current 25 A; suitable for 2002 and 2003 Series rail-mounted terminal blocks; light gray                           | <a href="http://www.wago.com/2002-481">www.wago.com/2002-481</a>                 |
|   | <b>Nr. articol: 2002-481/011-000</b><br>Ready-made staggered jumper; insulated; 1-3-5-7-9-11; Nominal current 25 A; with contact lugs broken off at the factory and circuit marking; light gray | <a href="http://www.wago.com/2002-481/011-000">www.wago.com/2002-481/011-000</a> |
|   | <b>Nr. articol: 2002-482</b><br>Staggered jumper; insulated; 12-way; Nominal current 25 A; suitable for 2002 and 2003 Series rail-mounted terminal blocks; light gray                           | <a href="http://www.wago.com/2002-482">www.wago.com/2002-482</a>                 |
|   | <b>Nr. articol: 210-103</b><br>Wire commoning chain; insulated; 50 connections; black   | <a href="http://www.wago.com/210-103">www.wago.com/210-103</a>                   |
|  | <b>Nr. articol: 210-123</b><br>Wire commoning chain; insulated; 50 connections  | <a href="http://www.wago.com/210-123">www.wago.com/210-123</a>                   |

## Descărcări

### Documentation

#### Additional Information

|                        |             |               |            |
|------------------------|-------------|---------------|------------|
| Technical explanations | Apr 3, 2019 | pdf<br>2,1 MB | Descărcare |
|------------------------|-------------|---------------|------------|

### CAD/CAE-Data

#### CAD data

|                        |     |            |
|------------------------|-----|------------|
| 2D/3D Models 2022-1204 | URL | Descărcare |
|------------------------|-----|------------|

#### CAE data

|                             |     |            |
|-----------------------------|-----|------------|
| EPLAN Data Portal 2022-1204 | URL | Descărcare |
|-----------------------------|-----|------------|

|                          |     |            |
|--------------------------|-----|------------|
| WSCAD Universe 2022-1204 | URL | Descărcare |
|--------------------------|-----|------------|

Supus modificărilor.

WAGO Kontakttechnik GmbH & Co. KG  
/Representative Office Romania  
Sos. Pipera-Tunari nr. 1/1  
building 1, 2nd floor | 077190 Voluntari, Ilfov  
Tel.: +40-(0)31 421 85 68 | Email: info-RO@wago.com

Aveți întrebări despre produsele noastre?  
Vă stăm la dispoziție pentru preluarea apelului la +40 (0) 31 421 85 68.

## Installation Notes

### Installation

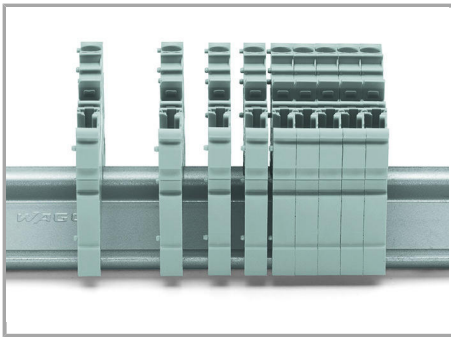

Snap individual carrier terminal blocks onto the carrier rail and slide together.

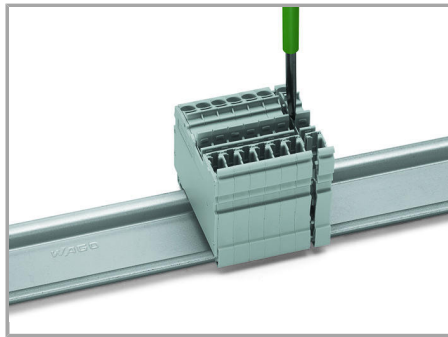

Open the assembly by laterally sliding a block via operating tool (3.5 x 0.5 mm blade).

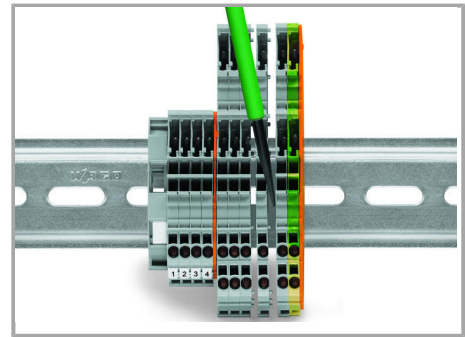

Separate terminal block assembly and slide individual terminal blocks laterally using an operating tool.

### Inserting a conductor

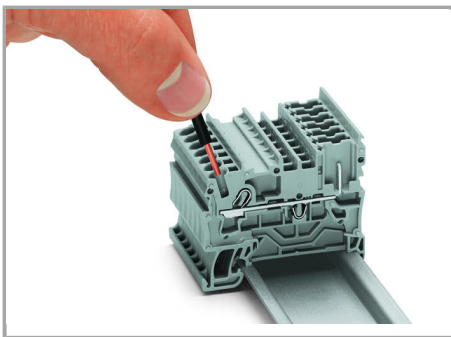

Push-in CAGE CLAMP® enables solid conductors and fine-stranded conductors with ferrules to be connected by simply pushing them into the unit.

### Commoning

Supus modificărilor.

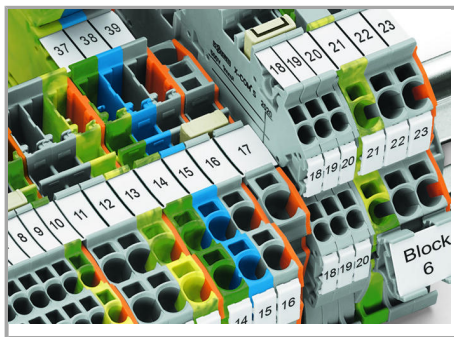

Commoning X-COM®S-SYSTEM Terminal Blocks using jumpers for TOPJOB® S Terminal Blocks. An end plate provides connection to TOPJOB® S Terminal Blocks. 2020 and 2022 Series Terminal Blocks are combinable. Jumper slots are on the same level for both series.

#### Testing

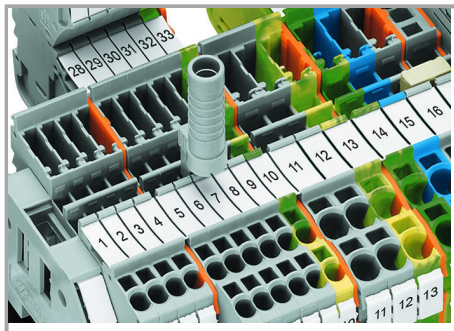

Test plug adapter (2009-174) for 4 mm test plugs or banana plugs – also suitable for X-COM®S-SYSTEM-MINI Terminal Blocks.

#### Coding

Supus modificărilor.

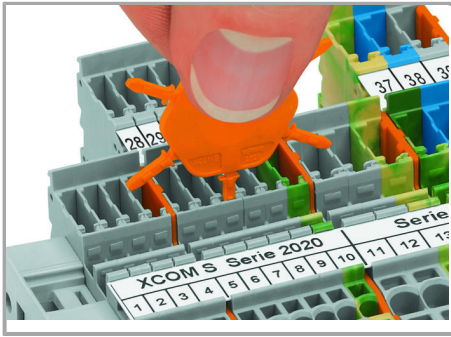

Insert coding pin into the corresponding slot and twist it off.

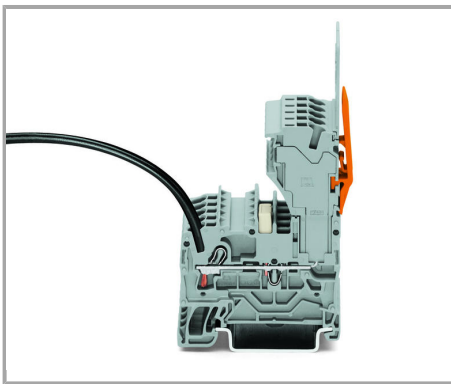

1-conductor female plug

Carrier terminal blocks can be commoned via 2000 Series Push-In Type Jumper Bars and tested via 859-500 Test Pin.

### Marking

Supus modificărilor.

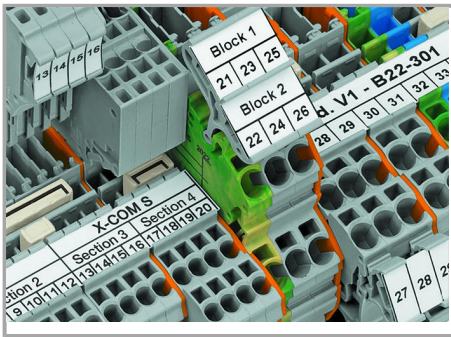

Clear marking via large marking area

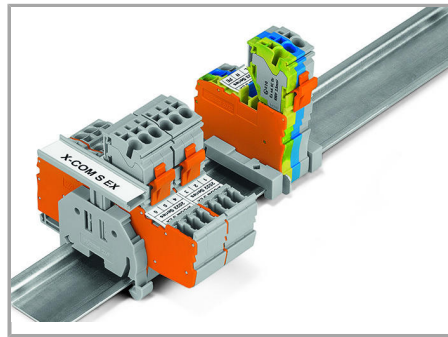

Group marking with height-adjustable group marker carrier (2009 163)

### Safety

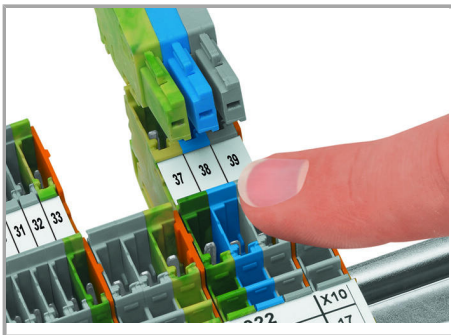

Carrier terminal blocks and female plugs are touch-proof.

### Familie de produse

#### X-COM S

Afișare globală produse din familie.

Supus modificărilor.