

Fișă tehnică | Număr articol: 885-112

Stud terminal block; lateral marker slots; for DIN-rail 35 x 15 and 35 x 7.5; 1 stud, M12; 120,00 mm²; gray

www.wago.com/885-112

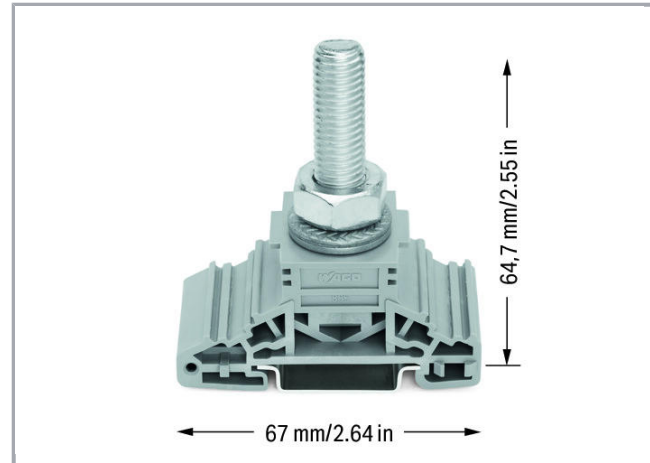

RoHS Compliant

[BOMcheck.net](https://www.bomcheck.net)

Culoare:

Date

Electrical data

Ratings per IEC/EN 60664-1

Nominal voltage (III/3)	1000 V
Rated surge voltage (III/3)	8 kV
Rated current	269 A
Legend (ratings)	(III / 3) ≙ Overvoltage category III / Pollution degree 3

Approvals per UL 1059

Approvals per	UL 1059
---------------	---------

Supus modificărilor.

WAGO Kontakttechnik GmbH & Co. KG
/Representative Office Romania
Sos. Pipera-Tunari nr. 1/1
building 1, 2nd floor | 077190 Voluntari, Ilfov
Tel.: +40-(0)31 421 85 68 | Email: info-RO@wago.com

Aveți întrebări despre produsele noastre?
Vă stăm la dispoziție pentru preluarea apelului la +40 (0) 31 421 85 68.



Connection data

Connection technology	Studs connection
Actuation type	Operating tool
Connectable conductor materials	Copper
Total number of connection points	1
Total number of potentials	1
Bolzenschraubverbindungen	M12

Geometrical Data

Width	33,8 mm / 1.331 inch
Height from upper-edge of DIN-rail	64,7 mm / 2.547 inch
Depth	67 mm / 2.638 inch

Mechanical data

Tightening torque	10 ... 20 Nm
Mounting type	DIN-35 rail
Marking level	Side marking

Material Data

Color	gray
Weight	115,1 g

Commercial data

Product Group	1 (Rail Mounted Terminal Blocks)
Packaging type	BOX
Country of origin	CN
GTIN	4050821092087
Customs tariff number	85369095990

Aprobări / certificate

Country specific Approvals

Emblemă	Aprobare	Text de aprobare suplimentar	Nume certificat
	CCA DEKRA Certification B.V.	EN 60947	2145295.01

Supus modificărilor.



	CCA	EN 60947	NTR NL
	DEKRA Certification B.V.		6882

	CSA	C22.2 No. 158	70038960
	DEKRA Certification B.V.		





UL-Approvals

Emblemă	Aprobare	Text de aprobare suplimentar	Nume certificat
	UL	UL 1059	E45172-
	UL International Germany GmbH		20120322

Counterpart

Produse compatibile













Marking accessories

	Nr. articol: 2009-110 Marking strips; on reel; not stretchable; plain; snap-on type; white	www.wago.com/2009-110
	Nr. articol: 2009-115 WMB-Inline; for Smart Printer; 1500 pieces on roll; stretchable 5 - 5.2 mm; plain; snap-on type; white	www.wago.com/2009-115
	Nr. articol: 2009-115/000-002 WMB-Inline; for Smart Printer; 1500 pieces on roll; stretchable 5 - 5.2 mm; plain; snap-on type; yellow	www.wago.com/2009-115/000-002
	Nr. articol: 2009-115/000-006 WMB-Inline; for Smart Printer; 1500 pieces on roll; stretchable 5 - 5.2 mm; plain; snap-on type; blue /000-006	www.wago.com/2009-115/000-006

Supus modificărilor.

WAGO Kontakttechnik GmbH & Co. KG
 /Representative Office Romania
 Sos. Pipera-Tunari nr. 1/1
 building 1, 2nd floor | 077190 Voluntari, Ilfov
 Tel.: +40-(0)31 421 85 68 | Email: info-RO@wago.com

Aveți întrebări despre produsele noastre?
 Vă stăm la dispoziție pentru preluarea apelului la +40 (0) 31 421 85 68.

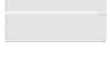
	Nr. articol: 2009-115/000-007 WMB-Inline; for Smart Printer; 1500 pieces on roll; stretchable 5 - 5.2 mm; plain; snap-on type; gray /000-007	www.wago.com/2009-115/000-007
	Nr. articol: 2009-115/000-012 WMB-Inline; for Smart Printer; 1500 pieces on roll; stretchable 5 - 5.2 mm; plain; snap-on type; orange	www.wago.com/2009-115/000-012
	Nr. articol: 2009-115/000-017 WMB-Inline; for Smart Printer; 1500 pieces on roll; stretchable 5 - 5.2 mm; plain; snap-on type; light green	www.wago.com/2009-115/000-017
	Nr. articol: 2009-115/000-023 WMB-Inline; for Smart Printer; 1500 pieces on roll; stretchable 5 - 5.2 mm; plain; snap-on type; green	www.wago.com/2009-115/000-023
	Nr. articol: 2009-115/000-024 WMB-Inline; for Smart Printer; 1500 pieces on roll; stretchable 5 - 5.2 mm; plain; snap-on type; violet	www.wago.com/2009-115/000-024
	Nr. articol: 2009-135 WMB-Inline; for Smart Printer; on reel; stretchable 5 - 5.2 mm; plain; snap-on type; white	www.wago.com/2009-135
	Nr. articol: 2009-198 Adaptor	www.wago.com/2009-198
Jumper		
	Nr. articol: 885-412 Assembled jumper bar; 2-way	www.wago.com/885-412
	Nr. articol: 885-432 Assembled jumper bar; 3-way	www.wago.com/885-432
End plate		
	Nr. articol: 885-530 Separator plate; 2 mm thick; 157 mm wide; gray	www.wago.com/885-530
	Nr. articol: 885-550 Separator plate with jumper bar recess; 2 mm thick; 157 mm wide; gray	www.wago.com/885-550
General accessories		
	Nr. articol: 885-580 Clip; secures cover against slipping	www.wago.com/885-580
assembling		
	Nr. articol: 885-570 Cover; 1 m long; transparent	www.wago.com/885-570

Descărcări**Documentation****Additional Information**

Supus modificărilor.

WAGO Kontakttechnik GmbH & Co. KG
/Representative Office Romania
Sos. Pipera-Tunari nr. 1/1
building 1, 2nd floor | 077190 Voluntari, Ilfov
Tel.: +40-(0)31 421 85 68 | Email: info-RO@wago.com

Aveți întrebări despre produsele noastre?
Vă stăm la dispoziție pentru preluarea apelului la +40 (0) 31 421 85 68.



Technical explanations

Apr 3, 2019

pdf
2,1 MB

Descărcare

CAD/CAE-Data

CAD data

2D/3D Models 885-112

URL

Descărcare

CAE data

EPLAN Data Portal 885-112

URL

Descărcare

WSCAD Universe 885-112

URL

Descărcare

Installation Notes

Supus modificărilor.

WAGO Kontakttechnik GmbH & Co. KG
/Representative Office Romania
Sos. Pipera-Tunari nr. 1/1
building 1, 2nd floor | 077190 Voluntari, Ilfov
Tel.: +40-(0)31 421 85 68 | Email: info-RO@wago.com

Aveți întrebări despre produsele noastre?
Vă stăm la dispoziție pentru preluarea apelului la +40 (0) 31 421 85 68.