

Descriere articol

- Protected against mismatching and maintenance-free
- Compact design with 4.4 mm pole spacing

Note:

All connectors for mounted installations (snap-in versions for lighting fixtures or devices, all types of PCB and distribution connectors) are factory-equipped with locking levers to ensure plugs and sockets are securely locked. Additional locking levers are only required for flying leads (plug /socket).

Note on mismatching protection:

All WINSTA[®] components are 100% protected against mismatching when:

- a.) plugging different numbers of poles
- b.) plugging while rotated 180
- c.) plugging while laterally staggered
- d.) plugging one pole

Safety information 1:

Supus modificărilor.



Application note for the U.S. market (USR): Some versions may also be used for current interruption in accordance with the UL certificate in select applications with currents below 5 A and voltages up to 600 V. For further information, please contact your local sales office.

Date

Electrical data

Note on Contact Resistance	approx. 1 mΩ of contact resistance approx. 0.25 mΩ contact transition plug/socket
----------------------------	---

Ratings per IEC/EN 60664-1

Ratings per	IEC/EN 60664-1
Nominal voltage (III/3)	250 V
Rated surge voltage (III/3)	4 kV
Rated current	16 A
Legend (ratings)	(III / 3) ≙ Overvoltage category III / Pollution degree 3

Approvals per UL 1977

Rated voltage UL 1977	600 V
Rated current UL 1977	14 A

Connection data

Pole No.	2
Total number of potentials	2

Geometrical Data

Pin spacing	4,4 mm / 0.173 inch
Width	12 mm / 0.472 inch
Height	29 mm / 1.142 inch
Depth	63,5 mm / 2.5 inch

Mechanical data

Technologie	DALI
Coding	I
Mating force of a plug-in connection	approx. 20 ... 70 N (depending on pole number)
Retention force of a plug-in connection	When locked: > 80 N
Unmating force of a plug-in connection	when unlocked: approx. 20 ... 70 N (depending on pole number)
Number of mating cycles	

Supus modificărilor.

WAGO Kontakttechnik GmbH & Co. KG
/Representative Office Romania
Sos. Pipera-Tunari nr. 1/1
building 1, 2nd floor | 077190 Voluntari, Ilfov
Tel.: +40-(0)31 421 85 68 | Email: info-RO@wago.com

Aveți întrebări despre produsele noastre?
Vă stăm la dispoziție pentru preluarea apelului la +40 (0) 31 421 85 68.



200, without resistive load

100, with resistive load $I_N = 16$ A, tested (1.5mm²/AWG 16)

Distributor type	Distribution connector, 3-way,
Marking	+ -
Protection type	IP20
Note on protection type	IP40 when mated
Potential marking	+ -
Application	Lighting management

Plug connection

Contact type (pluggable connector)	Socket/plug
Mismating protection	Yes
Locking of plug-in connection	locking lever
Locking lever	yes

Material Data

Color	blue
Insulation material	Polyamide 66 (PA 66)
Contact material	Copper or copper alloy (surface-treated)
Weight	11,9 g

Environmental Requirements

Processing temperature	-5 ... +40 °C
Continuous operating temperature	-35 ... +85 °C
Note on continuous operating temperature	Insulating parts for temperatures ≤ 105 °C

Commercial data

Packaging type	BOX
Country of origin	DE
GTIN	4055143608718
Customs tariff number	85366990990

Aprobări / certificate

UL-Approvals





Supus modificărilor.

WAGO Kontakttechnik GmbH & Co. KG
 /Representative Office Romania
 Sos. Pipera-Tunari nr. 1/1
 building 1, 2nd floor | 077190 Voluntari, Ilfov
 Tel.: +40-(0)31 421 85 68 | Email: info-RO@wago.com

Aveți întrebări despre produsele noastre?
 Vă stăm la dispoziție pentru preluarea apelului la +40 (0) 31 421 85 68.

Emblemă	Aprobare	Text de aprobare suplimentar	Nume certificat
	cURus Underwriters Laboratories Inc.	UL 1977	E45171

Counterpart

	Nr. articol 890-1102 Socket; 2-pole; Cod. I; 1,50 mm ² ; blue	www.wago.com/890-1102
	Nr. articol 890-1112 Plug; 2-pole; 1,50 mm ² ; blue	www.wago.com/890-1112
	Nr. articol 891-8982/006-101 pre-assembled interconnecting cable; Eca; Socket/plug; 2-pole; Cod. I; H05VV-F 2 x 1.5 mm ² ; 1 m; 1,50 mm ² ; blue	www.wago.com/891-8982/006-101
	Nr. articol 891-8982/106-101 pre-assembled connecting cable; Eca; Socket/open-ended; 2-pole; Cod. I; H05VV-F 2 x 1.5 mm ² ; 1 m; 1,50 mm ² ; blue	www.wago.com/891-8982/106-101
	Nr. articol 891-8982/206-101 pre-assembled connecting cable; Eca; Plug/open-ended; 2-pole; Cod. I; H05VV-F 2 x 1.5 mm ² ; 1 m; 1,50 mm ² ; blue	www.wago.com/891-8982/206-101

Installation Notes

Installation

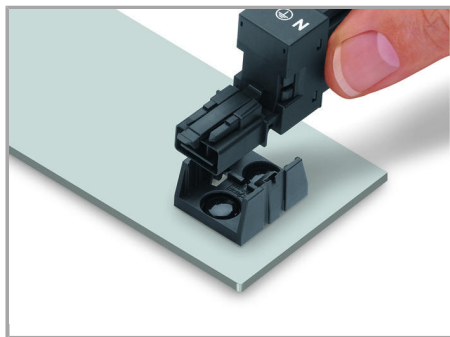

Secure the mounting plate via pins.

Familie de produse

<i>WINSTA</i>® MINI

Afișare globală produse din familie.

Supus modificărilor.

WAGO Kontakttechnik GmbH & Co. KG
/Representative Office Romania
Sos. Pipera-Tunari nr. 1/1
building 1, 2nd floor | 077190 Voluntari, Ilfov
Tel.: +40-(0)31 421 85 68 | Email: info-RO@wago.com

Aveți întrebări despre produsele noastre?
Vă stăm la dispoziție pentru preluarea apelului la +40 (0) 31 421 85 68.