

Fișă tehnică | Număr articol: 284-687/999-950

3-conductor ground terminal block; 10 mm²; suitable for Ex e II applications;
center marking; for DIN-rail 35 x 15 and 35 x 7.5; CAGE CLAMP®; 10,00 mm²;
green-yellow

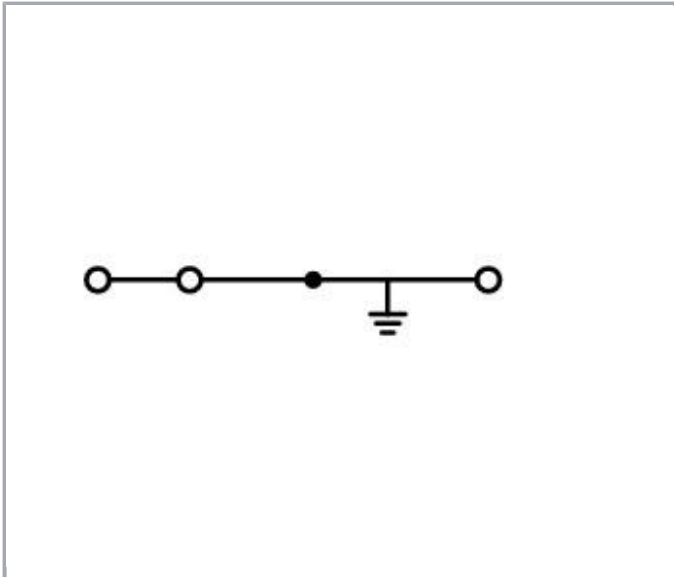

www.wago.com/284-687/999-950

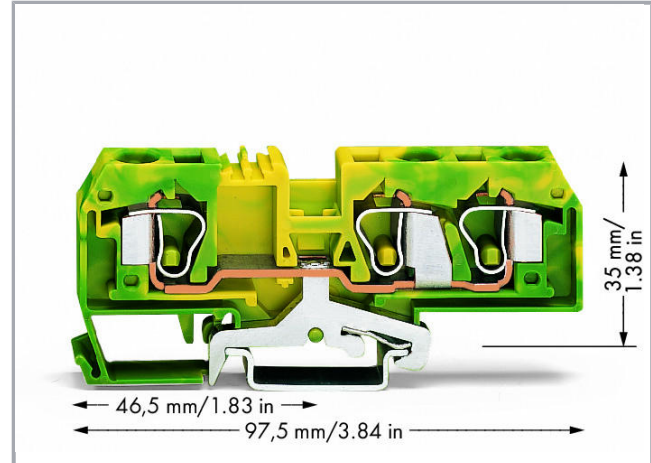
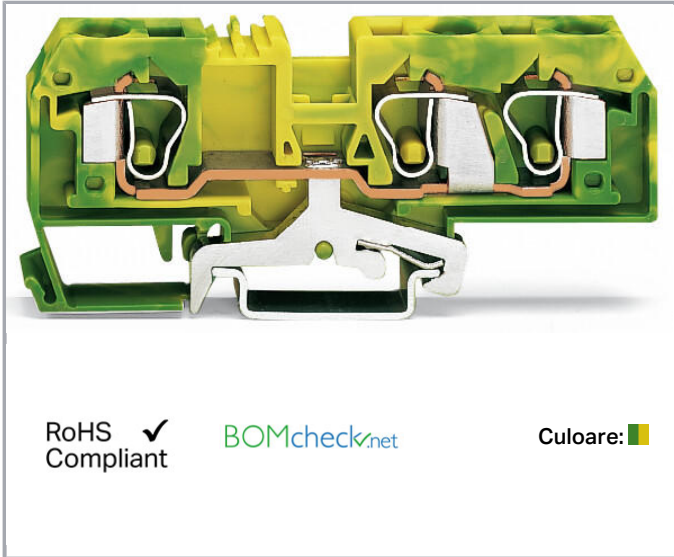

Date

Electrical data

Supus modificărilor.

WAGO Kontakttechnik GmbH & Co. KG
/Representative Office Romania
Sos. Pipera-Tunari nr. 1/1
building 1, 2nd floor | 077190 Voluntari, Ilfov
Tel.: +40-(0)31 421 85 68 | Email: info-RO@wago.com

Aveți întrebări despre produsele noastre?
Vă stăm la dispoziție pentru preluarea apelului la +40 (0) 31 421 85 68.

**Ratings per IEC/EN 60664-1**

| | |
|-------------|------------------|
| Ratings per | IEC/EN 60947-7-2 |
|-------------|------------------|

Connection data

| | |
|-----------------------------------|---|
| Connection technology | CAGE CLAMP® |
| Actuation type | Operating tool |
| Connectable conductor materials | Copper |
| Solid conductor | 0,2 ... 10 mm ² / 24 ... 8 AWG |
| Fine-stranded conductor | 0,2 ... 10 mm ² / 24 ... 8 AWG |
| Strip length | 12 ... 13 mm / 0.47 ... 0.51 inch |
| Total number of connection points | 3 |
| Total number of potentials | 1 |
| Number of levels | 1 |
| Wiring type | Front-entry wiring |

Geometrical Data

| | |
|------------------------------------|----------------------|
| Width | 10 mm / 0.394 inch |
| Height from upper-edge of DIN-rail | 35 mm / 1.378 inch |
| Depth | 97,5 mm / 3.839 inch |

Mechanical data

| | |
|---------------|----------------|
| Design | horizontal |
| Mounting type | DIN-35 rail |
| Marking level | Center marking |

Material Data

| | |
|---------------------|----------------------|
| Color | green-yellow |
| Insulation material | Polyamide 66 (PA 66) |
| Fire load | 0,409 MJ |
| Weight | 40 g |

Commercial data

| | |
|-------------------|-----|
| Packaging type | BOX |
| Country of origin | DE |

Supus modificărilor.



WAGO Kontakttechnik GmbH & Co. KG
 /Representative Office Romania
 Sos. Pipera-Tunari nr. 1/1
 building 1, 2nd floor | 077190 Voluntari, Ilfov
 Tel.: +40-(0)31 421 85 68 | Email: info-RO@wago.com

Aveți întrebări despre produsele noastre?
 Vă stăm la dispoziție pentru preluarea apelului la +40 (0) 31 421 85 68.



| | |
|-----------------------|---------------|
| GTIN | 4045454091569 |
| Customs tariff number | 85369010000 |

Aprobări / certificate

Ex-Approvals

| Embleă | Aprobare | Text de aprobare suplimentar | Nume certificat |
|--|---|------------------------------|--|
|  | AEx UL International Germany GmbH c/o Physikalisch Technische Bundesanstalt | UL 60079 | E185892 sec.1 |
|  | ATEX Physikalisch Technische Bundesanstalt (PTB) | EN 60079 | PTB 98 ATEX 3133 U (II 2 G EEx e II) |
|  | IECEX Physikalisch Technische Bundesanstalt (PTB) | IEC 60079 | IECEX PTB 14.0046 U (Ex e IIC Gb) |

Country specific Approvals

| Embleă | Aprobare | Text de aprobare suplimentar | Nume certificat |
|--|--|------------------------------|-----------------|
|  | CCA DEKRA Certification B.V. | EN 60947 | NTR NL- 7379 |
|  | KEMA/KEUR DEKRA Certification B.V. | EN 60947 | 2178517.01 |

Ship Approvals

| Embleă | Aprobare | Text de aprobare suplimentar | Nume certificat |
|--|---|------------------------------|--------------------------|
|  | ABS American Bureau of Shipping | EN 60947 | 20- HG1941090- PDA |
| | BV Bureau Veritas S.A. | EN 60947 | 07436/E0 BV |

Supus modificărilor.

WAGO Kontakttechnik GmbH & Co. KG
/Representative Office Romania
Sos. Pipera-Tunari nr. 1/1
building 1, 2nd floor | 077190 Voluntari, Ilfov
Tel.: +40-(0)31 421 85 68 | Email: info-RO@wago.com

Aveți întrebări despre produsele noastre?
Vă stăm la dispoziție pentru preluarea apelului la +40 (0) 31 421 85 68.

BUREAU
VERITAS**DNV GL**

Det Norske Veritas, Germanischer Lloyd

-

TAE00001V2

**LR**

Lloyds Register

EN 60947

91/20112
(E9)**UL-Approvals**

Emblemă

Aprobare

Text de aprobare suplimentar

Nume
certificat**UL**

UL International Germany GmbH

UL 1059

20190731-
E45172**Counterpart****Produse compatibile****tools****Nr. articol: 210-721**

Operating tool; Blade: 5.5 x 0.8 mm; with a partially insulated shaft

www.wago.com/210-721**Jumper****Nr. articol: 284-402**

Adjacent jumper; insulated; Nominal current 57 A; gray

www.wago.com/284-402**Nr. articol: 284-409**

Alternate jumper; insulated; Nominal current 57 A; gray

www.wago.com/284-409

Supus modificărilor.

WAGO Kontakttechnik GmbH & Co. KG
/Representative Office Romania
Sos. Pipera-Tunari nr. 1/1
building 1, 2nd floor | 077190 Voluntari, Ilfov
Tel.: +40-(0)31 421 85 68 | Email: info-RO@wago.com

Aveți întrebări despre produsele noastre?
Vă stăm la dispoziție pentru preluarea apelului la +40 (0) 31 421 85 68.



Nr. articol: 284-422
Adjacent jumper; insulated; Nominal current 57 A; yellow-green

www.wago.com/284-422

End plate



Nr. articol: 284-308
End and intermediate plate; 2.5 mm thick; gray

www.wago.com/284-308



Nr. articol: 284-309
Separator plate; 2 mm thick; oversized; gray

www.wago.com/284-309



Nr. articol: 284-339
End and intermediate plate; 2.5 mm thick; orange

www.wago.com/284-339



Nr. articol: 284-340
Separator plate; 2 mm thick; oversized; orange

www.wago.com/284-340



Nr. articol: 284-341
End and intermediate plate; 2.5 mm thick; light gray

www.wago.com/284-341



Nr. articol: 284-342
Separator plate; 2 mm thick; oversized; light gray

www.wago.com/284-342

assembling



Nr. articol: 209-106
Mounting carrier; for isolated mounting on DIN 35 rails; gray

www.wago.com/209-106



Nr. articol: 709-154
Cover; Type 2; suitable for cover carrier, type 2; 1 m long; transparent

www.wago.com/709-154

Carrier rail



Nr. articol: 210-112
Steel carrier rail; 35 x 7.5 mm; 1 mm thick; 2 m long; slotted; according to EN 60715; "Hole width 25 mm

www.wago.com/210-112



Nr. articol: 210-113
Steel carrier rail; 35 x 7.5 mm; 1 mm thick; 2 m long; unslotted; according to EN 60715

www.wago.com/210-113



Nr. articol: 210-114
Steel carrier rail; 35 x 15 mm; 1.5 mm thick; 2 m long; unslotted; similar to EN 60715

www.wago.com/210-114



Nr. articol: 210-115
Steel carrier rail; 35 x 7.5 mm; 1 mm thick; 2 m long; slotted; according to EN 60715; "Hole width 18 mm

www.wago.com/210-115



Nr. articol: 210-118
Steel carrier rail; 35 x 15 mm; 2.3 mm thick; 2 m long; unslotted; according to EN 60715

www.wago.com/210-118



Nr. articol: 210-196
Aluminum carrier rail; 35 x 8.2 mm; 1.6 mm thick; 2 m long; unslotted; similar to EN 60715; silver-colored

www.wago.com/210-196



Nr. articol: 210-197
Steel carrier rail; 35 x 15 mm; 1.5 mm thick; 2 m long; slotted; similar to EN 60715

www.wago.com/210-197

Nr. articol: 210-198

Supus modificărilor.

Copper carrier rail; 35 x 15 mm; 2.3 mm thick; 2 m long; unslotted; according to EN 60715; copper-colored www.wago.com/210-198



Nr. articol: 210-504
Steel carrier rail; 35 x 7.5 mm; 1 mm thick; 2 m long; slotted; galvanized; according to EN 60715 www.wago.com/210-504



Nr. articol: 210-505
Steel carrier rail; 35 x 7.5 mm; 1 mm thick; 2 m long; unslotted; galvanized; according to EN 60715 www.wago.com/210-505



Nr. articol: 210-506
Steel carrier rail; 35 x 15 mm; 1.5 mm thick; 2 m long; unslotted; galvanized; similar to EN 60715 www.wago.com/210-506



Nr. articol: 210-508
Steel carrier rail; 35 x 15 mm; 1.5 mm thick; 2 m long; slotted; galvanized; similar to EN 60715 www.wago.com/210-508

Marking accessories



Nr. articol: 2009-115
WMB-Inline; for Smart Printer; 1500 pieces on roll; stretchable 5 - 5.2 mm; plain; snap-on type; white www.wago.com/2009-115



Nr. articol: 2009-115/000-002
WMB-Inline; for Smart Printer; 1500 pieces on roll; stretchable 5 - 5.2 mm; plain; snap-on type; yellow www.wago.com/2009-115/000-002



Nr. articol: 2009-115/000-006
WMB-Inline; for Smart Printer; 1500 pieces on roll; stretchable 5 - 5.2 mm; plain; snap-on type; blue www.wago.com/2009-115/000-006



Nr. articol: 2009-115/000-007
WMB-Inline; for Smart Printer; 1500 pieces on roll; stretchable 5 - 5.2 mm; plain; snap-on type; gray www.wago.com/2009-115/000-007



Nr. articol: 2009-115/000-012
WMB-Inline; for Smart Printer; 1500 pieces on roll; stretchable 5 - 5.2 mm; plain; snap-on type; orange www.wago.com/2009-115/000-012



Nr. articol: 2009-115/000-017
WMB-Inline; for Smart Printer; 1500 pieces on roll; stretchable 5 - 5.2 mm; plain; snap-on type; light green www.wago.com/2009-115/000-017



Nr. articol: 2009-115/000-023
WMB-Inline; for Smart Printer; 1500 pieces on roll; stretchable 5 - 5.2 mm; plain; snap-on type; green www.wago.com/2009-115/000-023



Nr. articol: 2009-115/000-024
WMB-Inline; for Smart Printer; 1500 pieces on roll; stretchable 5 - 5.2 mm; plain; snap-on type; violet www.wago.com/2009-115/000-024



Nr. articol: 249-105
Group marker carrier; gray www.wago.com/249-105



Nr. articol: 793-501
WMB marking card; as card; not stretchable; plain; snap-on type; white www.wago.com/793-501

Supus modificărilor.



Nr. articol: 793-501/000-002
WMB marking card; as card; not stretchable; plain; snap-on type; yellow

www.wago.com/793-501/000-002



Nr. articol: 793-501/000-005
WMB marking card; as card; not stretchable; plain; snap-on type; red

www.wago.com/793-501/000-005



Nr. articol: 793-501/000-006
WMB marking card; as card; not stretchable; plain; snap-on type; blue

www.wago.com/793-501/000-006



Nr. articol: 793-501/000-007
WMB marking card; as card; not stretchable; plain; snap-on type; gray

www.wago.com/793-501/000-007



Nr. articol: 793-501/000-012
WMB marking card; as card; not stretchable; plain; snap-on type; orange

www.wago.com/793-501/000-012



Nr. articol: 793-501/000-017
WMB marking card; as card; not stretchable; plain; snap-on type; light green

www.wago.com/793-501/000-017



Nr. articol: 793-501/000-023
WMB marking card; as card; not stretchable; plain; snap-on type; green

www.wago.com/793-501/000-023



Nr. articol: 793-501/000-024
WMB marking card; as card; not stretchable; plain; snap-on type; violet

www.wago.com/793-501/000-024



Nr. articol: 793-5501
WMB marking card; as card; for terminal block width 5 - 17.5 mm; stretchable 5 - 5.2 mm; plain; snap-on type; white

www.wago.com/793-5501



Nr. articol: 793-5501/000-002
WMB marking card; as card; for terminal block width 5 - 17.5 mm; stretchable 5 - 5.2 mm; plain; snap-on type; yellow

www.wago.com/793-5501/000-002



Nr. articol: 793-5501/000-005
WMB marking card; as card; for terminal block width 5 - 17.5 mm; stretchable 5 - 5.2 mm; plain; snap-on type; red

www.wago.com/793-5501/000-005



Nr. articol: 793-5501/000-006
WMB marking card; as card; for terminal block width 5 - 17.5 mm; stretchable 5 - 5.2 mm; plain; snap-on type; blue

www.wago.com/793-5501/000-006



Nr. articol: 793-5501/000-007
WMB marking card; as card; for terminal block width 5 - 17.5 mm; stretchable 5 - 5.2 mm; plain; snap-on type; gray

www.wago.com/793-5501/000-007



Nr. articol: 793-5501/000-012
WMB marking card; as card; for terminal block width 5 - 17.5 mm; stretchable 5 - 5.2 mm; plain; snap-

www.wago.com/793-5501/000-012

Supus modificărilor.

on type; orange



Nr. articol: 793-5501/000-017

WMB marking card; as card; for terminal block width 5 - 17.5 mm; stretchable 5 - 5.2 mm; plain; snap-on type; green

www.wago.com/793-5501/000-017



Nr. articol: 793-5501/000-023

WMB marking card; as card; for terminal block width 5 - 17.5 mm; stretchable 5 - 5.2 mm; plain; snap-on type; light green

www.wago.com/793-5501/000-023



Nr. articol: 793-5501/000-024

WMB marking card; as card; for terminal block width 5 - 17.5 mm; stretchable 5 - 5.2 mm; plain; snap-on type; violet

www.wago.com/793-5501/000-024

protection



Nr. articol: 284-415

Protective warning marker; with high-voltage symbol, black; for 5 terminal blocks; yellow

www.wago.com/284-415

General accessories



Nr. articol: 284-400

Finger guard; touchproof cover protects unused conductor entries; yellow

www.wago.com/284-400



Nr. articol: 709-310

B-type test plug module; modular; suitable for all WAGO 282 Series rail-mounted terminal blocks with jumper slots; 6,00 mm²; gray

www.wago.com/709-310



Nr. articol: 709-311

B-type spacer module; modular; e.g., for bridging commoned terminal blocks; gray

www.wago.com/709-311



Nr. articol: 709-312

B-type intermediate plate; modular; snaps on 709-310 B-type test plug modules and 709-311 B-type spacer modules; Module width 2 mm; gray

www.wago.com/709-312

ferrule



Nr. articol: 216-108

Ferrule; Sleeve for 6 mm² / AWG 10; uninsulated; electro-tin plated

www.wago.com/216-108



Nr. articol: 216-208

Ferrule; Sleeve for 6 mm² / AWG 10; insulated; electro-tin plated; electrolytic copper; gastight crimped; acc. to DIN 46228, Part 4/09.90; yellow

www.wago.com/216-208



Nr. articol: 216-262

Ferrule; Sleeve for 0.75 mm² / 18 AWG; insulated; electro-tin plated; electrolytic copper; gastight crimped; acc. to DIN 46228, Part 4/09.90; gray

www.wago.com/216-262



Nr. articol: 216-263

Ferrule; Sleeve for 1 mm² / AWG 18; insulated; electro-tin plated; electrolytic copper; gastight crimped; acc. to DIN 46228, Part 4/09.90; red

www.wago.com/216-263



Nr. articol: 216-264

Ferrule; Sleeve for 1.5 mm² / AWG 16; insulated; electro-tin plated; electrolytic copper; gastight crimped; acc. to DIN 46228, Part 4/09.90; black

www.wago.com/216-264



Nr. articol: 216-266

Ferrule; Sleeve for 2.5 mm² / AWG 14; insulated; electro-tin plated; electrolytic copper; gastight crimped; acc. to DIN 46228, Part 4/09.90; blue

www.wago.com/216-266

Nr. articol: 216-267

Supus modificărilor.



Ferrule; Sleeve for 4 mm² / AWG 12; insulated; electro-tin plated; electrolytic copper; gastight crimped; acc. to DIN 46228, Part 4/09.90; gray

www.wago.com/216-267

Descărcări Documentation

Additional Information

Technical explanations

Apr 3, 2019

pdf
2,1 MB

Descărcare

CAD/CAE-Data

CAD data

2D/3D Models 284-687/999-950

URL

Descărcare

CAE data

EPLAN Data Portal 284-687/999-950

URL

Descărcare

WSCAD Universe 284-687/999-950

URL

Descărcare

Installation Notes

Installation

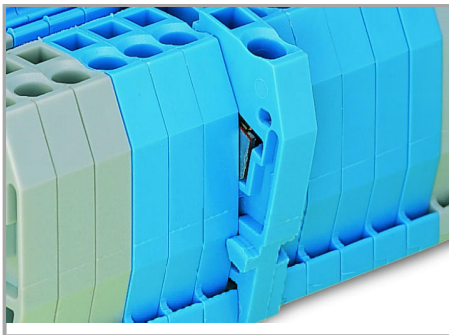

Quick assembly keys prevent reverse mounting.

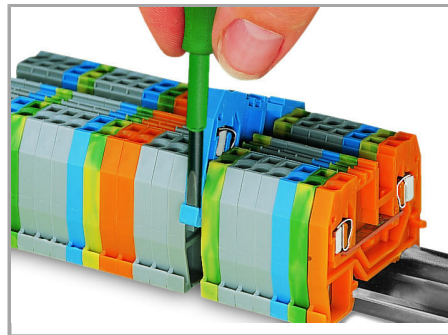

Removing a terminal block from the assembly.

Inserting a conductor

Supus modificărilor.

WAGO Kontakttechnik GmbH & Co. KG
/Representative Office Romania
Sos. Pipera-Tunari nr. 1/1
building 1, 2nd floor | 077190 Voluntari, Ilfov
Tel.: +40-(0)31 421 85 68 | Email: info-RO@wago.com

Aveți întrebări despre produsele noastre?
Vă stăm la dispoziție pentru preluarea apelului la +40 (0) 31 421 85 68.

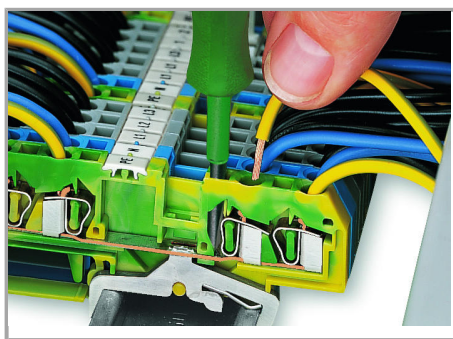

CAGE CLAMP® connection

Inserting a conductor.

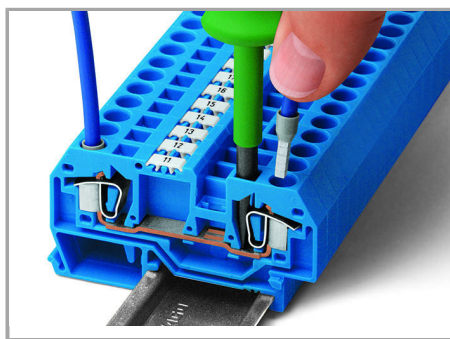

CAGE CLAMP® connection

Inserting a conductor.

With ferruled conductors, it is necessary to use a terminal block one size larger than the conductor's nominal cross-section.

Testing

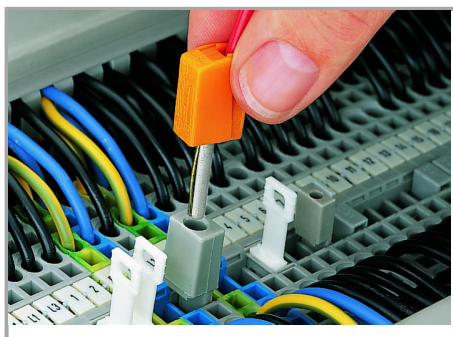

Testing with a test plug

(picture shows 209-170 Test Plug Adapter).

Marking

Supus modificărilor.

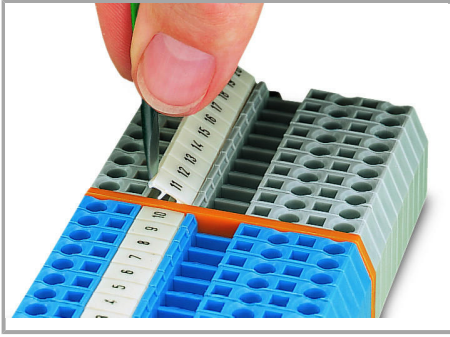

Marking via WMB Multi Marking System.

Supus modificărilor.