

Fișă tehnică | Număr articol: 270-564

3-conductor sensor supply terminal block; Internal commoning, 9 A; with colored conductor entries; 2.5 mm<sup>2</sup>; CAGE CLAMP®; 2,50 mm<sup>2</sup>; orange

[www.wago.com/270-564](http://www.wago.com/270-564)

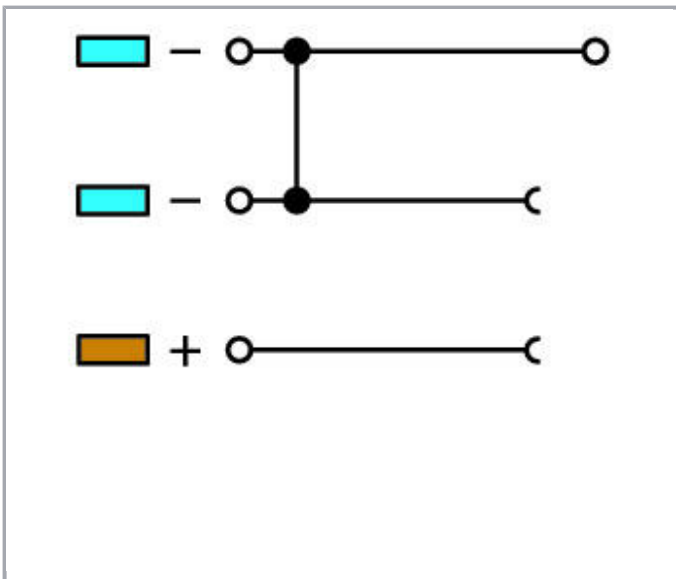
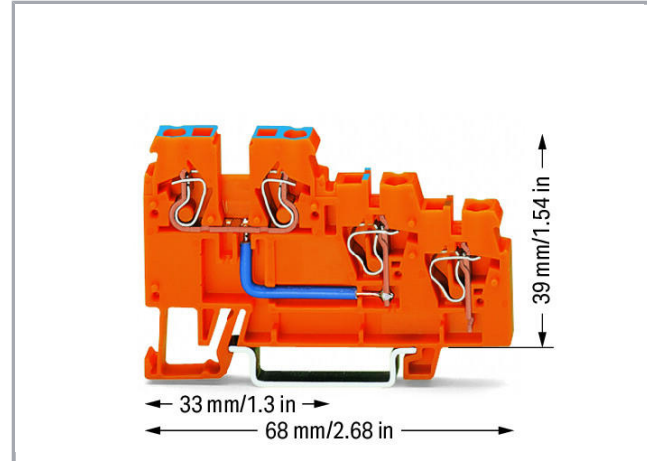
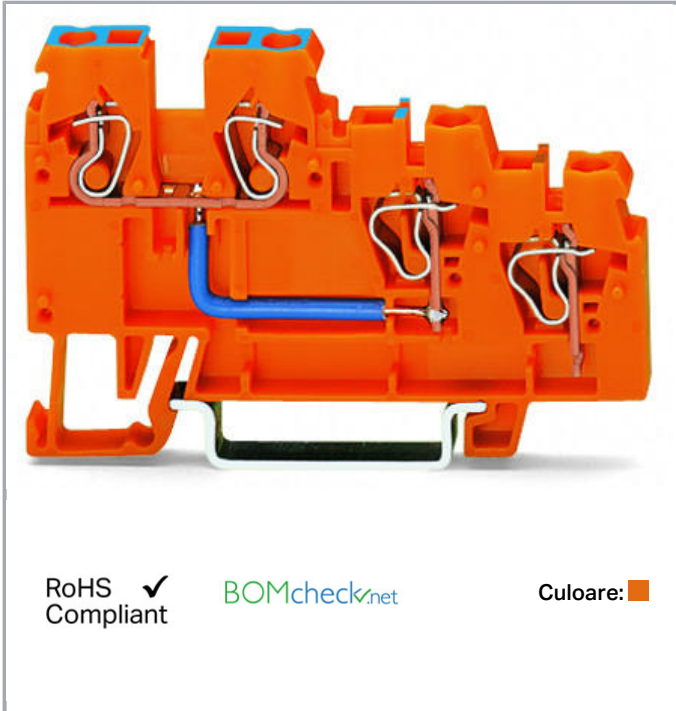

Descriere articol

Supus modificărilor.

WAGO Kontakttechnik GmbH & Co. KG  
/Representative Office Romania  
Sos. Pipera-Tunari nr. 1/1  
building 1, 2nd floor | 077190 Voluntari, Ilfov  
Tel.: +40-(0)31 421 85 68 | Email: info-RO@wago.com

Aveți întrebări despre produsele noastre?  
Vă stăm la dispoziție pentru preluarea apelului la +40 (0) 31 421 85 68.

**Safety information 1:**

Internal bridge: 9 A

**Date****Electrical data****Ratings per IEC/EN 60664-1**

Nominal voltage (III/3)	250 V
Rated surge voltage (III/3)	4 kV
Rated current	18 A
Legend (ratings)	(III / 3) ≙ Overvoltage category III / Pollution degree 3

**Connection data**

Connection technology	CAGE CLAMP®
Actuation type	Operating tool
Connectable conductor materials	Copper
Solid conductor	0,08 ... 2,5 mm <sup>2</sup> / 28 ... 12 AWG
Fine-stranded conductor	0,08 ... 2,5 mm <sup>2</sup> / 28 ... 12 AWG
Strip length	6 ... 7 mm / 0.24 ... 0.28 inch
Total number of connection points	4
Total number of potentials	2
Number of levels	3
Wiring type	Front-entry wiring
Note (conductor cross-section)	12 AWG: THHN, THWN

**Geometrical Data**

Width	5 mm / 0.197 inch
Height from upper-edge of DIN-rail	39 mm / 1.535 inch
Depth	68 mm / 2.677 inch

**Mechanical data**

Design	horizontal type
Mounting type	DIN-35 rail
Marking level	Side marking

Supus modificărilor.

WAGO Kontakttechnik GmbH & Co. KG  
 /Representative Office Romania  
 Sos. Pipera-Tunari nr. 1/1  
 building 1, 2nd floor | 077190 Voluntari, Ilfov  
 Tel.: +40-(0)31 421 85 68 | Email: info-RO@wago.com

Aveți întrebări despre produsele noastre?  
 Vă stăm la dispoziție pentru preluarea apelului la +40 (0) 31 421 85 68.

## Material Data



Color	orange
Fire load	0,175 MJ
Weight	9,3 g

## Commercial data

Product Group	1 (Rail Mounted Terminal Blocks)
Packaging type	BOX
Country of origin	CN
GTIN	4045454193768
Customs tariff number	85369010000

## Aprobări / certificate

### Country specific Approvals

Emblemă	Aprobare	Text de aprobare suplimentar	Nume certificat
	CCA DEKRA Certification B.V.	EN 60947	NTR NL 6828
	CCA DEKRA Certification B.V.	EN 60947	2143311.03
	CSA DEKRA Certification B.V.	C22.2	1565649

## Counterpart













## Produse compatibile

## Marking accessories

Supus modificărilor.

WAGO Kontakttechnik GmbH & Co. KG  
/Representative Office Romania  
Sos. Pipera-Tunari nr. 1/1  
building 1, 2nd floor | 077190 Voluntari, Ilfov  
Tel.: +40-(0)31 421 85 68 | Email: info-RO@wago.com















Aveți întrebări despre produsele noastre?  
Vă stăm la dispoziție pentru preluarea apelului la +40 (0) 31 421 85 68.

	<b>Nr. articol: 2009-115</b> WMB-Inline; for Smart Printer; 1500 pieces on roll; stretchable 5 - 5.2 mm; plain; snap-on type; white	<a href="http://www.wago.com/2009-115">www.wago.com/2009-115</a>
	<b>Nr. articol: 2009-115/000-002</b> WMB-Inline; for Smart Printer; 1500 pieces on roll; stretchable 5 - 5.2 mm; plain; snap-on type; yellow	<a href="http://www.wago.com/2009-115/000-002">www.wago.com/2009-115/000-002</a>
	<b>Nr. articol: 2009-115/000-006</b> WMB-Inline; for Smart Printer; 1500 pieces on roll; stretchable 5 - 5.2 mm; plain; snap-on type; blue	<a href="http://www.wago.com/2009-115/000-006">www.wago.com/2009-115/000-006</a>
	<b>Nr. articol: 2009-115/000-007</b> WMB-Inline; for Smart Printer; 1500 pieces on roll; stretchable 5 - 5.2 mm; plain; snap-on type; gray	<a href="http://www.wago.com/2009-115/000-007">www.wago.com/2009-115/000-007</a>
	<b>Nr. articol: 2009-115/000-012</b> WMB-Inline; for Smart Printer; 1500 pieces on roll; stretchable 5 - 5.2 mm; plain; snap-on type; orange	<a href="http://www.wago.com/2009-115/000-012">www.wago.com/2009-115/000-012</a>
	<b>Nr. articol: 2009-115/000-017</b> WMB-Inline; for Smart Printer; 1500 pieces on roll; stretchable 5 - 5.2 mm; plain; snap-on type; light green	<a href="http://www.wago.com/2009-115/000-017">www.wago.com/2009-115/000-017</a>
	<b>Nr. articol: 2009-115/000-023</b> WMB-Inline; for Smart Printer; 1500 pieces on roll; stretchable 5 - 5.2 mm; plain; snap-on type; green	<a href="http://www.wago.com/2009-115/000-023">www.wago.com/2009-115/000-023</a>
	<b>Nr. articol: 2009-115/000-024</b> WMB-Inline; for Smart Printer; 1500 pieces on roll; stretchable 5 - 5.2 mm; plain; snap-on type; violet	<a href="http://www.wago.com/2009-115/000-024">www.wago.com/2009-115/000-024</a>
	<b>Nr. articol: 2009-145</b> Mini-WSB Inline; for Smart Printer; 1700 pieces on roll; stretchable 5 - 5.2 mm; plain; snap-on type; white	<a href="http://www.wago.com/2009-145">www.wago.com/2009-145</a>
	<b>Nr. articol: 2009-145/000-002</b> Mini-WSB Inline; for Smart Printer; 1700 pieces on roll; stretchable 5 - 5.2 mm; plain; snap-on type; yellow	<a href="http://www.wago.com/2009-145/000-002">www.wago.com/2009-145/000-002</a>
	<b>Nr. articol: 2009-145/000-005</b> Mini-WSB Inline; for Smart Printer; 1700 pieces on roll; stretchable 5 - 5.2 mm; plain; snap-on type; red	<a href="http://www.wago.com/2009-145/000-005">www.wago.com/2009-145/000-005</a>
	<b>Nr. articol: 2009-145/000-006</b> Mini-WSB Inline; for Smart Printer; 1700 pieces on roll; stretchable 5 - 5.2 mm; plain; snap-on type; blue	<a href="http://www.wago.com/2009-145/000-006">www.wago.com/2009-145/000-006</a>
	<b>Nr. articol: 2009-145/000-007</b> Mini-WSB Inline; for Smart Printer; 1700 pieces on roll; stretchable 5 - 5.2 mm; plain; snap-on type; gray	<a href="http://www.wago.com/2009-145/000-007">www.wago.com/2009-145/000-007</a>
	<b>Nr. articol: 2009-145/000-012</b> Mini-WSB Inline; for Smart Printer; 1700 pieces on roll; stretchable 5 - 5.2 mm; plain; snap-on type; orange	<a href="http://www.wago.com/2009-145/000-012">www.wago.com/2009-145/000-012</a>

Supus modificărilor.















WAGO Kontakttechnik GmbH & Co. KG  
/Representative Office Romania  
Sos. Pipera-Tunari nr. 1/1  
building 1, 2nd floor | 077190 Voluntari, Ilfov  
Tel.: +40-(0)31 421 85 68 | Email: info-RO@wago.com

Aveți întrebări despre produsele noastre?  
Vă stăm la dispoziție pentru preluarea apelului la +40 (0) 31 421 85 68.

	<b>Nr. articol: 2009-145/000-023</b> Mini-WSB Inline; for Smart Printer; 1700 pieces on roll; stretchable 5 - 5.2 mm; plain; snap-on type; green	<a href="http://www.wago.com/2009-145/000-023">www.wago.com/2009-145/000-023</a>
	<b>Nr. articol: 2009-145/000-024</b> Mini-WSB Inline; for Smart Printer; 1700 pieces on roll; stretchable 5 - 5.2 mm; plain; snap-on type; violet	<a href="http://www.wago.com/2009-145/000-024">www.wago.com/2009-145/000-024</a>
	<b>Nr. articol: 248-501</b> Miniature WSB Quick marking system; plain; Marker width 5 mm; 10 strips with 10 markers per card	<a href="http://www.wago.com/248-501">www.wago.com/248-501</a>
	<b>Nr. articol: 248-501/000-002</b> Mini-WSB marking card; as card; not stretchable; plain; snap-on type; yellow	<a href="http://www.wago.com/248-501/000-002">www.wago.com/248-501/000-002</a>
	<b>Nr. articol: 248-501/000-005</b> Mini-WSB marking card; as card; not stretchable; plain; snap-on type; red	<a href="http://www.wago.com/248-501/000-005">www.wago.com/248-501/000-005</a>
	<b>Nr. articol: 248-501/000-006</b> Mini-WSB marking card; as card; not stretchable; plain; snap-on type; blue	<a href="http://www.wago.com/248-501/000-006">www.wago.com/248-501/000-006</a>
	<b>Nr. articol: 248-501/000-007</b> Mini-WSB marking card; as card; not stretchable; plain; snap-on type; gray	<a href="http://www.wago.com/248-501/000-007">www.wago.com/248-501/000-007</a>
	<b>Nr. articol: 248-501/000-012</b> Mini-WSB marking card; as card; not stretchable; plain; snap-on type; orange	<a href="http://www.wago.com/248-501/000-012">www.wago.com/248-501/000-012</a>
	<b>Nr. articol: 248-501/000-017</b> Mini-WSB marking card; as card; not stretchable; plain; snap-on type; light green	<a href="http://www.wago.com/248-501/000-017">www.wago.com/248-501/000-017</a>
	<b>Nr. articol: 248-501/000-023</b> Mini-WSB marking card; as card; not stretchable; plain; snap-on type; green	<a href="http://www.wago.com/248-501/000-023">www.wago.com/248-501/000-023</a>
	<b>Nr. articol: 248-501/000-024</b> Mini-WSB marking card; as card; not stretchable; plain; snap-on type; violet	<a href="http://www.wago.com/248-501/000-024">www.wago.com/248-501/000-024</a>
	<b>Nr. articol: 709-177</b> Marking strips; on reel; 7.5 mm wide; not stretchable; plain; snap-on type; translucent	<a href="http://www.wago.com/709-177">www.wago.com/709-177</a>
	<b>Nr. articol: 709-178</b> Marking strips; on reel; 7.5 mm wide; not stretchable; plain; snap-on type; white	<a href="http://www.wago.com/709-178">www.wago.com/709-178</a>
	<b>Nr. articol: 709-196</b> Marking strips; for laser printer; translucent	<a href="http://www.wago.com/709-196">www.wago.com/709-196</a>

**Nr. articol: 709-198**

Supus modificărilor.

	Marking strips; white	<a href="http://www.wago.com/709-198">www.wago.com/709-198</a>
	<b>Nr. articol: 793-501</b> WMB marking card; as card; not stretchable; plain; snap-on type; white	<a href="http://www.wago.com/793-501">www.wago.com/793-501</a>
	<b>Nr. articol: 793-501/000-002</b> WMB marking card; as card; not stretchable; plain; snap-on type; yellow	<a href="http://www.wago.com/793-501/000-002">www.wago.com/793-501/000-002</a>
	<b>Nr. articol: 793-501/000-005</b> WMB marking card; as card; not stretchable; plain; snap-on type; red	<a href="http://www.wago.com/793-501/000-005">www.wago.com/793-501/000-005</a>
	<b>Nr. articol: 793-501/000-006</b> WMB marking card; as card; not stretchable; plain; snap-on type; blue	<a href="http://www.wago.com/793-501/000-006">www.wago.com/793-501/000-006</a>
	<b>Nr. articol: 793-501/000-007</b> WMB marking card; as card; not stretchable; plain; snap-on type; gray	<a href="http://www.wago.com/793-501/000-007">www.wago.com/793-501/000-007</a>
	<b>Nr. articol: 793-501/000-012</b> WMB marking card; as card; not stretchable; plain; snap-on type; orange	<a href="http://www.wago.com/793-501/000-012">www.wago.com/793-501/000-012</a>
	<b>Nr. articol: 793-501/000-017</b> WMB marking card; as card; not stretchable; plain; snap-on type; light green	<a href="http://www.wago.com/793-501/000-017">www.wago.com/793-501/000-017</a>
	<b>Nr. articol: 793-501/000-023</b> WMB marking card; as card; not stretchable; plain; snap-on type; green	<a href="http://www.wago.com/793-501/000-023">www.wago.com/793-501/000-023</a>
	<b>Nr. articol: 793-501/000-024</b> WMB marking card; as card; not stretchable; plain; snap-on type; violet	<a href="http://www.wago.com/793-501/000-024">www.wago.com/793-501/000-024</a>
	<b>Nr. articol: 793-5501</b> WMB marking card; as card; for terminal block width 5 - 17.5 mm; stretchable 5 - 5.2 mm; plain; snap-on type; white	<a href="http://www.wago.com/793-5501">www.wago.com/793-5501</a>
	<b>Nr. articol: 793-5501/000-002</b> WMB marking card; as card; for terminal block width 5 - 17.5 mm; stretchable 5 - 5.2 mm; plain; snap-on type; yellow	<a href="http://www.wago.com/793-5501/000-002">www.wago.com/793-5501/000-002</a>
	<b>Nr. articol: 793-5501/000-005</b> WMB marking card; as card; for terminal block width 5 - 17.5 mm; stretchable 5 - 5.2 mm; plain; snap-on type; red	<a href="http://www.wago.com/793-5501/000-005">www.wago.com/793-5501/000-005</a>
	<b>Nr. articol: 793-5501/000-006</b> WMB marking card; as card; for terminal block width 5 - 17.5 mm; stretchable 5 - 5.2 mm; plain; snap-on type; blue	<a href="http://www.wago.com/793-5501/000-006">www.wago.com/793-5501/000-006</a>

Supus modificărilor.



**Nr. articol: 793-5501/000-007**

WMB marking card; as card; for terminal block width 5 - 17.5 mm; stretchable 5 - 5.2 mm; plain; snap-on type; gray

[www.wago.com/793-5501/000-007](http://www.wago.com/793-5501/000-007)



**Nr. articol: 793-5501/000-012**

WMB marking card; as card; for terminal block width 5 - 17.5 mm; stretchable 5 - 5.2 mm; plain; snap-on type; orange

[www.wago.com/793-5501/000-012](http://www.wago.com/793-5501/000-012)



**Nr. articol: 793-5501/000-017**

WMB marking card; as card; for terminal block width 5 - 17.5 mm; stretchable 5 - 5.2 mm; plain; snap-on type; green

[www.wago.com/793-5501/000-017](http://www.wago.com/793-5501/000-017)



**Nr. articol: 793-5501/000-023**

WMB marking card; as card; for terminal block width 5 - 17.5 mm; stretchable 5 - 5.2 mm; plain; snap-on type; light green

[www.wago.com/793-5501/000-023](http://www.wago.com/793-5501/000-023)



**Nr. articol: 793-5501/000-024**

WMB marking card; as card; for terminal block width 5 - 17.5 mm; stretchable 5 - 5.2 mm; plain; snap-on type; violet

[www.wago.com/793-5501/000-024](http://www.wago.com/793-5501/000-024)

#### Insulation stop



**Nr. articol: 280-470**

Insulation stop; 0.08 - 0.2 mm<sup>2</sup> "s" (0.14 mm<sup>2</sup> "f-st"); 5 pieces/strip; white

[www.wago.com/280-470](http://www.wago.com/280-470)



**Nr. articol: 280-471**

Insulation stop; 0.25 - 0.5 mm<sup>2</sup>; 5 pieces/strip; light gray

[www.wago.com/280-471](http://www.wago.com/280-471)



**Nr. articol: 280-472**

Insulation stop; 0.75 - 1 mm<sup>2</sup>; 5 pieces/strip

[www.wago.com/280-472](http://www.wago.com/280-472)

#### tools



**Nr. articol: 210-657**

Operating tool; Blade: 3.5 x 0.5 mm; with a partially insulated shaft; short

[www.wago.com/210-657](http://www.wago.com/210-657)



**Nr. articol: 210-720**

Operating tool; Blade: 3.5 x 0.5 mm; with a partially insulated shaft

[www.wago.com/210-720](http://www.wago.com/210-720)

#### End plate



**Nr. articol: 270-321**

End and intermediate plate; 1 mm thick; for triple-deck terminal blocks; orange

[www.wago.com/270-321](http://www.wago.com/270-321)

#### ferrule



**Nr. articol: 216-121**

Ferrule; Sleeve for 0.5 mm<sup>2</sup> / AWG 22; uninsulated; electro-tin plated

[www.wago.com/216-121](http://www.wago.com/216-121)



**Nr. articol: 216-122**

Ferrule; Sleeve for 0.75 mm<sup>2</sup> / AWG 20; uninsulated; electro-tin plated

[www.wago.com/216-122](http://www.wago.com/216-122)



**Nr. articol: 216-123**

Ferrule; Sleeve for 1 mm<sup>2</sup> / AWG 18; uninsulated; electro-tin plated

[www.wago.com/216-123](http://www.wago.com/216-123)



















**Nr. articol: 216-124**

Ferrule; Sleeve for 1.5 mm<sup>2</sup> / AWG 16; uninsulated; electro-tin plated

[www.wago.com/216-124](http://www.wago.com/216-124)

Supus modificărilor.

	<b>Nr. articol: 216-131</b> Ferrule; Sleeve for 0.25 mm <sup>2</sup> / AWG 24; uninsulated; electro-tin plated	<a href="http://www.wago.com/216-131">www.wago.com/216-131</a>
	<b>Nr. articol: 216-132</b> Ferrule; Sleeve for 0.34 mm <sup>2</sup> / AWG 24; uninsulated; electro-tin plated	<a href="http://www.wago.com/216-132">www.wago.com/216-132</a>
	<b>Nr. articol: 216-221</b> Ferrule; Sleeve for 0.5 mm <sup>2</sup> / 20 AWG; insulated; electro-tin plated; white	<a href="http://www.wago.com/216-221">www.wago.com/216-221</a>
	<b>Nr. articol: 216-222</b> Ferrule; Sleeve for 0.75 mm <sup>2</sup> / 18 AWG; insulated; electro-tin plated; gray	<a href="http://www.wago.com/216-222">www.wago.com/216-222</a>
	<b>Nr. articol: 216-223</b> Ferrule; Sleeve for 1 mm <sup>2</sup> / AWG 18; insulated; electro-tin plated; red	<a href="http://www.wago.com/216-223">www.wago.com/216-223</a>
	<b>Nr. articol: 216-224</b> Ferrule; Sleeve for 1.5 mm <sup>2</sup> / AWG 16; insulated; electro-tin plated; black	<a href="http://www.wago.com/216-224">www.wago.com/216-224</a>
	<b>Nr. articol: 216-321</b> Ferrule; Sleeve for 0.25 mm <sup>2</sup> / AWG 24; insulated; electro-tin plated; yellow	<a href="http://www.wago.com/216-321">www.wago.com/216-321</a>
	<b>Nr. articol: 216-322</b> Ferrule; Sleeve for 0.34 mm <sup>2</sup> / 22 AWG; insulated; electro-tin plated; green	<a href="http://www.wago.com/216-322">www.wago.com/216-322</a>
<b>Jumper</b>		
	<b>Nr. articol: 270-409</b> Jumper; unplated; 9-way; Nominal current 18 A; silver-colored	<a href="http://www.wago.com/270-409">www.wago.com/270-409</a>
	<b>Nr. articol: 270-417</b> Jumper; unplated; 17-way; Nominal current 18 A; silver-colored	<a href="http://www.wago.com/270-417">www.wago.com/270-417</a>
	<b>Nr. articol: 270-480</b> Jumper; unplated; 80-way; Nominal current 18 A; silver-colored	<a href="http://www.wago.com/270-480">www.wago.com/270-480</a>
	<b>Nr. articol: 870-402</b> Push-in type jumper bar; insulated; 2-way; Nominal current 18 A; light gray	<a href="http://www.wago.com/870-402">www.wago.com/870-402</a>
	<b>Nr. articol: 870-403</b> Push-in type jumper bar; insulated; 3-way; Nominal current 18 A; light gray	<a href="http://www.wago.com/870-403">www.wago.com/870-403</a>
	<b>Nr. articol: 870-404</b> Push-in type jumper bar; insulated; 4-way; Nominal current 18 A; light gray	<a href="http://www.wago.com/870-404">www.wago.com/870-404</a>
	<b>Nr. articol: 870-405</b> Push-in type jumper bar; insulated; 5-way; Nominal current 18 A; light gray	<a href="http://www.wago.com/870-405">www.wago.com/870-405</a>
	<b>Nr. articol: 870-405/011-000</b> Ready-made push-in type jumper bar; insulated; 3-way (1-3-5); Nominal current 18 A; light gray	<a href="http://www.wago.com/870-405/011-000">www.wago.com/870-405/011-000</a>
	<b>Nr. articol: 870-406</b> Push-in type jumper bar; insulated; 6-way; Nominal current 18 A; light gray	<a href="http://www.wago.com/870-406">www.wago.com/870-406</a>
	<b>Nr. articol: 870-407</b>	

Supus modificărilor.





Push-in type jumper bar; insulated; 7-way; Nominal current 18 A; light gray

[www.wago.com/870-407](http://www.wago.com/870-407)



**Nr. articol: 870-407/011-000**

Ready-made push-in type jumper bar; insulated; 1-3-5-7; Nominal current 18 A; light gray

[www.wago.com/870-407/011-000](http://www.wago.com/870-407/011-000)



**Nr. articol: 870-408**

Push-in type jumper bar; insulated; 8-way; Nominal current 18 A; light gray

[www.wago.com/870-408](http://www.wago.com/870-408)



**Nr. articol: 870-409**

Push-in type jumper bar; insulated; 9-way; Nominal current 18 A; light gray

[www.wago.com/870-409](http://www.wago.com/870-409)



**Nr. articol: 870-409/011-000**

Ready-made push-in type jumper bar; insulated; 1-3-5-7-9; Nominal current 18 A; light gray

[www.wago.com/870-409/011-000](http://www.wago.com/870-409/011-000)

## Descărcări Documentation

### Additional Information

Technical explanations	Apr 3, 2019	pdf 2,1 MB	Descărcare
------------------------	-------------	---------------	------------

## CAD/CAE-Data

### CAD data

2D/3D Models 270-564	URL	Descărcare
----------------------	-----	------------

### CAE data

EPLAN Data Portal 270-564	URL	Descărcare
---------------------------	-----	------------

WSCAD Universe 270-564	URL	Descărcare
------------------------	-----	------------

## Installation Notes

### Commoning

Supus modificărilor.

WAGO Kontakttechnik GmbH & Co. KG  
/Representative Office Romania  
Sos. Pipera-Tunari nr. 1/1  
building 1, 2nd floor | 077190 Voluntari, Ilfov  
Tel.: +40-(0)31 421 85 68 | Email: [info-RO@wago.com](mailto:info-RO@wago.com)

Aveți întrebări despre produsele noastre?  
Vă stăm la dispoziție pentru preluarea apelului la +40 (0) 31 421 85 68.

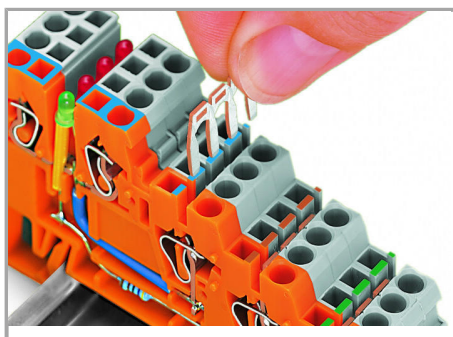

Inserting a jumper.

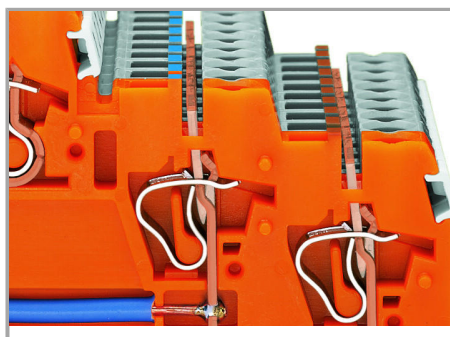

Commoning a supply voltage using uninsulated push-in type jumper bars, 2- to 9-way or 17-way (2 x 8 bits), depending on application.



Commoning signal level voltage via insulated push-in type jumper bars (870 Series) – 2- to 9-way, depending on application.

**Sensor LED terminal blocks cannot be commoned!**

#### Application



Terminal block assembly:

Sensor terminal blocks

#### Marking

Supus modificărilor.

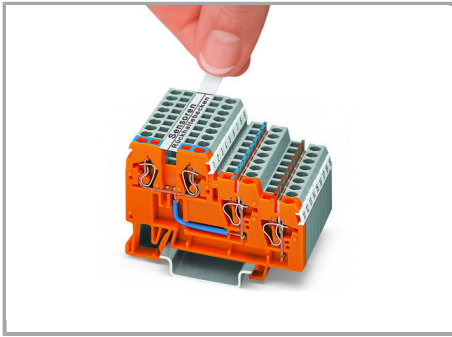

Marking strip (Item No. 709-196)

**Not suitable for LED terminal blocks!**

Supus modificărilor.