

Fișă tehnică | Număr articol: 770-611

Three-phase to single-phase distribution connector; with phase selection; 5-pole/3-pole; Cod. A; 1 input; 2 outputs; with cable connection on the input side; black

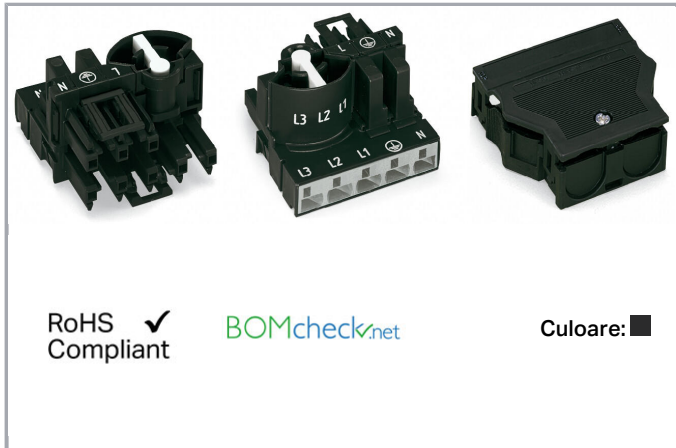

www.wago.com/770-611



RoHS Compliant ✓

BOMcheck.net

Culoare: ■

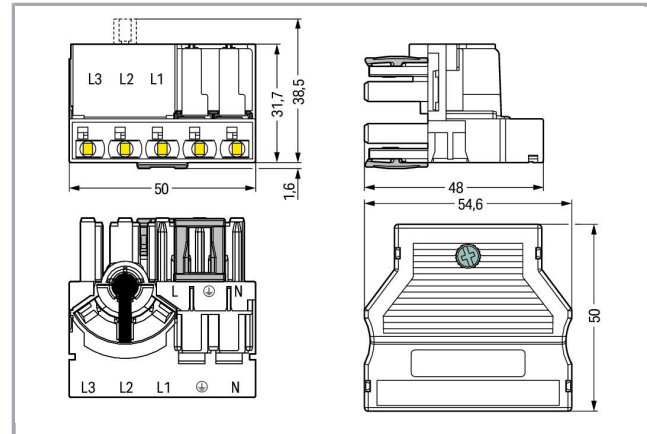

Descriere articol

- Protected against mismatching and maintenance-free
- Additional variable coding is possible

Note:

All connectors for mounted installations (snap-in versions for lighting fixtures or devices, all types of PCB and distribution connectors) are factory-equipped with locking levers to ensure plugs and sockets are securely locked. Additional locking levers are only required for flying leads (plug /socket).

Note on mismatching protection:

All WINSTA[®] components are 100% protected against mismatching when:

- plugging different numbers of poles
- plugging while rotated 180
- plugging while laterally staggered
- plugging one pole

Safety information 1:

Application note for the U.S. market (USR): Some versions may also be used for current interruption in accordance with the UL certificate in select applications with currents below 16 A and voltages up to 600 V. For further information, please contact your local sales office.

Date

Electrical data

Note on Contact Resistance

approx. 1 mΩ of contact resistance approx. 0.25 mΩ contact transition plug/socket

Supus modificărilor.

WAGO Kontakttechnik GmbH & Co. KG
/Representative Office Romania
Sos. Pipera-Tunari nr. 1/1
building 1, 2nd floor | 077190 Voluntari, Ilfov
Tel.: +40-(0)31 421 85 68 | Email: info-RO@wago.com

Aveți întrebări despre produsele noastre?
Vă stăm la dispoziție pentru preluarea apelului la +40 (0) 31 421 85 68.

Ratings per IEC/EN 60664-1

Ratings per	IEC/EN 60664-1
Nominal voltage (III/3)	400 V
Rated surge voltage (III/3)	6 kV
Rated current	25 A
Rated voltage (III/3) 2	250 V
Rated surge voltage (III/3) 2	4 kV
Legend (ratings)	(III / 3) ≙ Overvoltage category III / Pollution degree 3

Approvals per UL 1977

Rated voltage UL 1977	600 V
Rated current UL 1977	23 A

Connection data

Connection technology	Push-in CAGE CLAMP®
Actuation type	Operating tool Push-in
Nominal cross-section	4 mm ²
Solid conductor	0,5 ... 4 mm ² / 20 ... 12 AWG
Solid conductor; push-in termination	1,5 ... 4 mm ² / 16 ... 12 AWG
Stranded conductor	0,5 ... 2,5 mm ² / 20 ... 14 AWG
Fine-stranded conductor	0,5 ... 4 mm ² / 20 ... 12 AWG
Fine-stranded conductor; with insulated ferrule	0,25 ... 1,5 mm ² / 20 ... 16 AWG
Fine-stranded conductor; with uninsulated ferrule	0,25 ... 2,5 mm ² / 20 ... 14 AWG
Fine-stranded conductor; with ferrule; push-in termination	1,5 mm ² / 16 AWG
Strip length	9 mm / 0.35 inch
Pole No.	5
Total number of connection points	5
Total number of potentials	5
Ground function	with preceding ground contact
Connectable sheathed cable diameter	9 ... 13 mm

Geometrical Data

Pin spacing	10 mm / 0.394 inch
Width	50 mm / 1.969 inch

Supus modificărilor.

WAGO Kontakttechnik GmbH & Co. KG
/Representative Office Romania
Sos. Pipera-Tunari nr. 1/1
building 1, 2nd floor | 077190 Voluntari, Ilfov
Tel.: +40-(0)31 421 85 68 | Email: info-RO@wago.com

Aveți întrebări despre produsele noastre?
Vă stăm la dispoziție pentru preluarea apelului la +40 (0) 31 421 85 68.



Height	31,7 mm / 1.248 inch
Depth	48 mm / 1.89 inch

Mechanical data

Coding	A
Mating force of a plug-in connection	approx. 20 ... 70 N (depending on pole number)
Retention force of a plug-in connection	When locked: > 80 N
Unmating force of a plug-in connection	when unlocked: approx. 20 ... 70 N (depending on pole number)
Number of mating cycles	200, without resistive load 100, with resistive load $I_N = 25$ A, tested (4 mm ² /AWG 12)
Distributor type	Distribution connector with phase selection
Marking	N L1 L2 L3
Protection type	IP20
Note on protection type	Only when mated (these compact connectors are not designed for use in open, easily accessible areas).
Potential marking	N L1 L2 L3
Application	General mains applications

Plug connection

Contact type (pluggable connector)	Socket/plug
Mismating protection	Yes
Locking of plug-in connection	locking lever
Locking lever	yes

Material Data

Color	black
Insulation material	Polyamide 66 (PA 66)
Clamping spring material	Chrome nickel spring steel (CrNi)
Contact material	Copper or copper alloy (surface-treated)
Fire load	1,008 MJ
Weight	47,3 g

Environmental Requirements

Processing temperature	-5 ... +40 °C
Continuous operating temperature	-35 ... +85 °C
Note on continuous operating temperature	Insulating parts for temperatures ≤ 105 °C

Supus modificărilor.

WAGO Kontakttechnik GmbH & Co. KG
 /Representative Office Romania
 Sos. Pipera-Tunari nr. 1/1
 building 1, 2nd floor | 077190 Voluntari, Ilfov
 Tel.: +40-(0)31 421 85 68 | Email: info-RO@wago.com

Aveți întrebări despre produsele noastre?
 Vă stăm la dispoziție pentru preluarea apelului la +40 (0) 31 421 85 68.

Commercial data

Packaging type	BOX
Country of origin	DE
GTIN	4045454558406
Customs tariff number	85366990990

Aprobări / certificate







Country specific Approvals

Emblemă	Aprobare	Text de aprobare suplimentar	Nume certificat
	CCA DEKRA Certification B.V.	EN 61535	2173495.02

Ship Approvals

Emblemă	Aprobare	Text de aprobare suplimentar	Nume certificat
	ABS American Bureau of Shipping	-	19- HG1868589- PDA

Counterpart

	Nr. articol 770-113 Plug; with strain relief housing; 3-pole; Cod. A; 4,00 mm ² ; black	www.wago.com/770-113
	Nr. articol 770-115 Plug; with strain relief housing; 5-pole; Cod. A; 4,00 mm ² ; black	www.wago.com/770-115
	Nr. articol 770-213/035-000 Plug; with strain relief housing; 3-pole; Cod. A; 4,00 mm ² ; black	www.wago.com/770-213/035-000
	Nr. articol 770-213 Plug; 3-pole; Cod. A; 4,00 mm ² ; black	www.wago.com/770-213
	Nr. articol 770-215 Plug; 5-pole; Cod. A; 4,00 mm ² ; black	www.wago.com/770-215
	Nr. articol 770-315 Plug; with strain relief housing; 5-pole; Cod. A; 4,00 mm ² ; black	www.wago.com/770-315

Supus modificărilor.

WAGO Kontakttechnik GmbH & Co. KG
/Representative Office Romania
Sos. Pipera-Tunari nr. 1/1
building 1, 2nd floor | 077190 Voluntari, Ilfov
Tel.: +40-(0)31 421 85 68 | Email: info-RO@wago.com

Aveți întrebări despre produsele noastre?
Vă stăm la dispoziție pentru preluarea apelului la +40 (0) 31 421 85 68.



Nr. articol770-415
Plug; 5-pole; Cod. A; 4,00 mm²; black

www.wago.com/770-415



Nr. articol771-9993/006-101
pre-assembled interconnecting cable; Eca; Socket/plug; 3-pole; Cod. A; H05VV-F 3G 1.5 mm²; 1 m; 1,50 mm²; black

www.wago.com/771-9993/006-101



Nr. articol771-9993/206-101
pre-assembled connecting cable; Eca; Plug/open-ended; 3-pole; Cod. A; H05VV-F 3G 1.5 mm²; 1 m; 1,50 mm²; black

www.wago.com/771-9993/206-101



Nr. articol771-9995/006-101
pre-assembled interconnecting cable; Eca; Socket/plug; 5-pole; Cod. A; H05VV-F 5G 1.5 mm²; 1 m; 1,50 mm²; black

www.wago.com/771-9995/006-101



Nr. articol771-9995/206-101
pre-assembled connecting cable; Eca; Plug/open-ended; 5-pole; Cod. A; H05VV-F 5G 1.5 mm²; 1 m; 1,50 mm²; black

www.wago.com/771-9995/206-101

Produse compatibile

tools



Nr. articol: 210-720
Operating tool; Blade: 3.5 x 0.5 mm; with a partially insulated shaft

www.wago.com/210-720



Nr. articol: 770-100
Wiring aid; for solid and stranded conductors; orange

www.wago.com/770-100

Descărcări

CAD/CAE-Data

CAD data

2D/3D Models 770-611	URL	Descărcare

CAE data

EPLAN Data Portal 770-611	URL	Descărcare

WSCAD Universe 770-611	URL	Descărcare

Installation Notes

Supus modificărilor.

WAGO Kontakttechnik GmbH & Co. KG
/Representative Office Romania
Sos. Pipera-Tunari nr. 1/1
building 1, 2nd floor | 077190 Voluntari, Ilfov
Tel.: +40-(0)31 421 85 68 | Email: info-RO@wago.com

Aveți întrebări despre produsele noastre?
Vă stăm la dispoziție pentru preluarea apelului la +40 (0) 31 421 85 68.

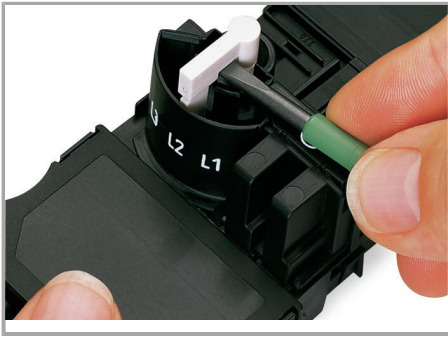

Lift jumper out of delivery position (L2) using a screwdriver and move it into the desired position.



Push down jumper in its new position (picture shows L3).

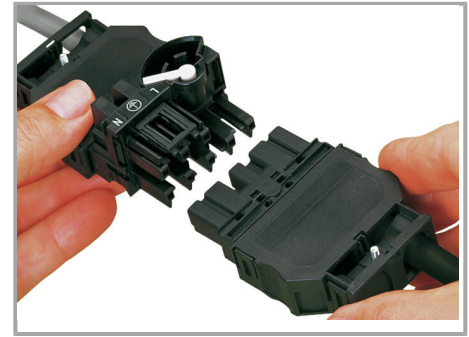

The 5-pole energy circuit can be extended using pluggable cable assemblies.

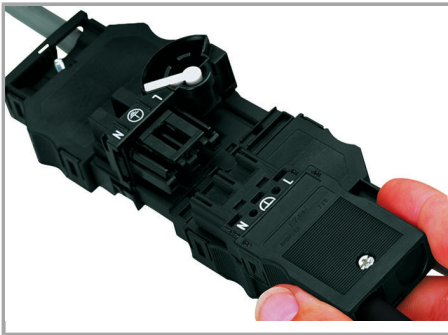

Plugging a 3-pole tap-off cable.

Installation

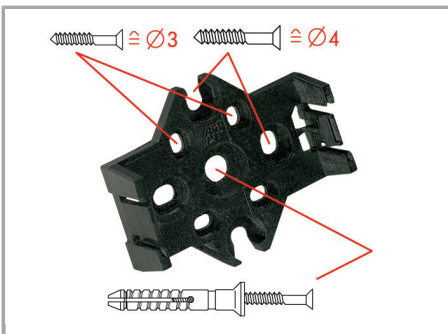

The mounting plate for distribution connectors can be mounted using commercially available screws or nail-drive anchors.



The distribution connectors are latched when mounted on the mounting plate.



To release the distribution connector, unlock the latch using a screwdriver.

Supus modificărilor.

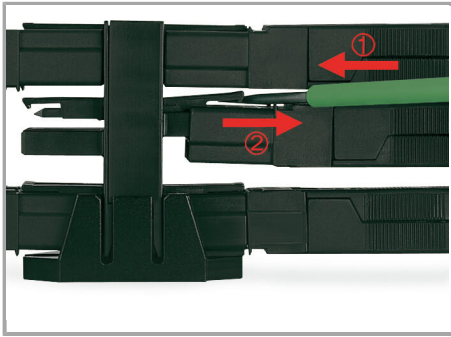

All distributor connections are locked and protected against accidental disconnection directly after mating. Locking of any connection is released using a screwdriver, even if all connections are in use.

Familie de produse

WINSTA® MIDI

Afișare globală produse din familie.

Supus modificărilor.