

Fișă tehnică | Număr articol: 731-512/031-000

1-conductor female plug; angled; clamping collar; 2.5 mm²; Pin spacing 5 mm; 12-pole; 2,50 mm²; gray

www.wago.com/731-512/031-000

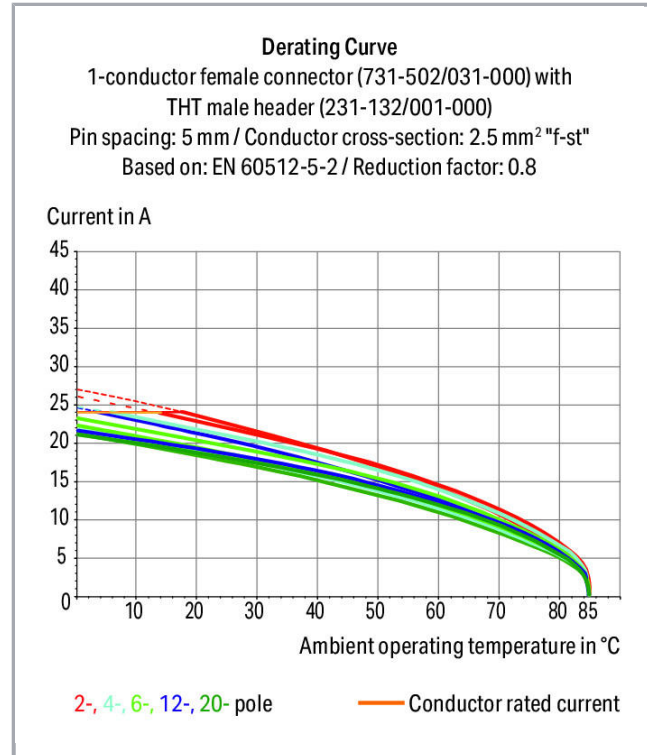

Supus modificărilor.

WAGO Kontakttechnik GmbH & Co. KG
/Representative Office Romania
Sos. Pipera-Tunari nr. 1/1
building 1, 2nd floor | 077190 Voluntari, Ilfov
Tel.: +40-(0)31 421 85 68 | Email: info-RO@wago.com

Aveți întrebări despre produsele noastre?
Vă stăm la dispoziție pentru preluarea apelului la +40 (0) 31 421 85 68.

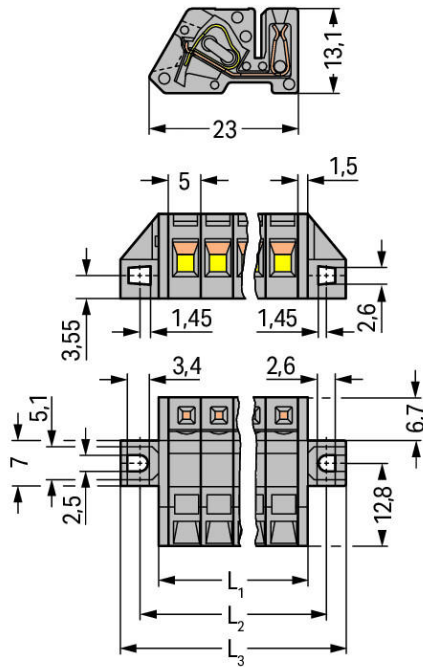

$L_1 = (\text{pole no.} \times \text{pin spacing}) + 3 \text{ mm}$

$L_2 = (\text{pole no.} \times \text{pin spacing}) + 8.8 \text{ mm}$

$L_3 = (\text{pole no.} \times \text{pin spacing}) + 14.8 \text{ mm}$

Descriere articol

- Universal connection for all conductor types
- Versions available with snap-in mounting feet or flanges for panel or through-panel mounting
- Mounting adapter allows versions with snap-in mounting feet to be DIN-rail mounted
- Easy conductor termination, even when halves are mated

Safety information 1:

The *MULTI CONNECTION SYSTEM (MCS)* is designed without breaking capacity for compliance with DIN EN 61984. When used as intended, MCS Connectors shall not be connected/disconnected when live or under load. The circuit design should ensure header pins, which can be touched, are not live when unmated.

Supus modificărilor.

WAGO Kontakttechnik GmbH & Co. KG
 /Representative Office Romania
 Sos. Pipera-Tunari nr. 1/1
 building 1, 2nd floor | 077190 Voluntari, Ilfov
 Tel.: +40-(0)31 421 85 68 | Email: info-RO@wago.com

Aveți întrebări despre produsele noastre?

Vă stăm la dispoziție pentru preluarea apelului la +40 (0) 31 421 85 68.

**Date****Electrical data****Ratings per IEC/EN 60664-1**

| Ratings per | IEC/EN 60664-1 |
|-----------------------------|---|
| Nominal voltage (III/3) | 320 V |
| Rated surge voltage (III/3) | 4 kV |
| Rated voltage (III/2) | 320 V |
| Rated surge voltage (III/2) | 4 kV |
| Nominal voltage (II/2) | 630 V |
| Rated surge voltage (II/2) | 4 kV |
| Rated current | 12 A |
| Legend (ratings) | (III / 2) ≙ Overvoltage category III / Pollution degree 2 |

Approvals per UL 1059

| | |
|--------------------------------|---------|
| Rated voltage UL (Use Group B) | 300 V |
| Rated current UL (Use Group B) | 15 A |
| Rated voltage UL (Use Group D) | 300 V |
| Rated current UL (Use Group D) | 10 A |
| Approvals per | UL 1059 |

Approvals per UL 1977

| | |
|-----------------------|-------|
| Rated voltage UL 1977 | 600 V |
| Rated current UL 1977 | 15 A |

Approvals per CSA

| | |
|---------------------------------|-------|
| Rated voltage CSA (Use Group B) | 300 V |
| Rated current CSA (Use Group B) | 15 A |
| Rated voltage CSA (Use Group D) | 300 V |
| Rated current CSA (Use Group D) | 10 A |

Connection data

| | |
|-------------------------|--|
| Connection technology | CAGE CLAMP® |
| Actuation type | Operating tool |
| Solid conductor | 0.08 ... 2.5 mm ² / 28 ... 12 AWG |
| Fine-stranded conductor | 0.08 ... 2.5 mm ² / 28 ... 12 AWG |

Supus modificărilor.

WAGO Kontakttechnik GmbH & Co. KG
 /Representative Office Romania
 Sos. Pipera-Tunari nr. 1/1
 building 1, 2nd floor | 077190 Voluntari, Ilfov
 Tel.: +40-(0)31 421 85 68 | Email: info-RO@wago.com

Aveți întrebări despre produsele noastre?
 Vă stăm la dispoziție pentru preluarea apelului la +40 (0) 31 421 85 68.



| | |
|---|---------------------------------|
| Fine-stranded conductor; with insulated ferrule | 0.25 ... 1.5 mm ² |
| Fine-stranded conductor; with uninsulated ferrule | 0.25 ... 2.5 mm ² |
| Strip length | 7 ... 8 mm / 0.28 ... 0.31 inch |
| Pole No. | 12 |
| Total number of connection points | 12 |
| Total number of potentials | 12 |
| Number of connection types | 1 |
| Number of levels | 1 |
| Conductor entry direction to mating direction | 90° |

Geometrical Data

| | |
|-------------|----------------------|
| Pin spacing | 5 mm / 0.197 inch |
| Width | 74.8 mm / 2.945 inch |
| Height | 13.1 mm / 0.516 inch |
| Depth | 23 mm / 0.906 inch |

Mechanical data

| | |
|---------------|---|
| Design | angled; mountable |
| Mounting type | Mounting flange |
| Mounting type | Feed-through mounting Panel mounting |

Plug connection

| | |
|------------------------------------|-------------------------|
| Contact type (pluggable connector) | Female connector/socket |
| Connector (connection type) | for conductors |
| Mismating protection | No |

Material Data

| | |
|-----------------------------|-----------------------------------|
| Color | gray |
| Material group | I |
| Insulation material | Polyamide 66 (PA 66) |
| Flammability class per UL94 | V0 |
| Clamping spring material | Chrome nickel spring steel (CrNi) |
| Contact material | Copper alloy |
| Contact plating | tin-plated |
| Fire load | 0,355 MJ |
| Weight | 17,9 g |

Supus modificărilor.

WAGO Kontakttechnik GmbH & Co. KG
/Representative Office Romania
Sos. Pipera-Tunari nr. 1/1
building 1, 2nd floor | 077190 Voluntari, Ilfov
Tel.: +40-(0)31 421 85 68 | Email: info-RO@wago.com

Aveți întrebări despre produsele noastre?
Vă stăm la dispoziție pentru preluarea apelului la +40 (0) 31 421 85 68.

Environmental Requirements



| | |
|-------------------------|----------------|
| Limit temperature range | -60 ... +85 °C |
|-------------------------|----------------|

Commercial data

| | |
|-----------------------|------------------------|
| Product Group | 3 (Multi Conn. System) |
| Packaging type | BOX |
| Country of origin | PL |
| GTIN | 4044918575249 |
| Customs tariff number | 85366990990 |

Aprobări / certificate

Country specific Approvals

| Emblemă | Aprobare | Text de aprobare suplimentar | Nume certificat |
|--|---------------------------------------|------------------------------|-----------------|
|  | CSA DEKRA Certification B.V. | C22.2 | 1466354 |
|  | KEMA/KEUR DEKRA Certification B.V. | EN 61984 | 2190761.01 |

Ship Approvals

| Emblemă | Aprobare | Text de aprobare suplimentar | Nume certificat |
|--|------------------------------------|------------------------------|--------------------------|
|  | ABS American Bureau of Shipping | - | 19- HG1869876- PDA |

UL-Approvals

| Emblemă | Aprobare | Text de aprobare suplimentar | Nume certificat |
|--|--------------------------------------|------------------------------|---------------------|
|  | UL Underwriters Laboratories Inc. | UL 1977 | E45171 |
| | UL Underwriters Laboratories Inc. | UL 1059 | 20190731- E45172 |

Supus modificărilor.



Counterpart











Nr. articol 231-612

1-conductor male connector; 2.5 mm²; Pin spacing 5 mm; 12-pole; 2,50 mm²; gray

www.wago.com/231-612

Produse compatibile

















ferrule

| | | |
|---|--|--|
|  | <p>Nr. articol: 216-106 Ferrule; Sleeve for 2.5 mm² / AWG 14; uninsulated; electro-tin plated</p> | www.wago.com/216-106 |
|  | <p>Nr. articol: 216-121 Ferrule; Sleeve for 0.5 mm² / AWG 22; uninsulated; electro-tin plated</p> | www.wago.com/216-121 |
|  | <p>Nr. articol: 216-122 Ferrule; Sleeve for 0.75 mm² / AWG 20; uninsulated; electro-tin plated</p> | www.wago.com/216-122 |
|  | <p>Nr. articol: 216-123 Ferrule; Sleeve for 1 mm² / AWG 18; uninsulated; electro-tin plated</p> | www.wago.com/216-123 |
|  | <p>Nr. articol: 216-124 Ferrule; Sleeve for 1.5 mm² / AWG 16; uninsulated; electro-tin plated</p> | www.wago.com/216-124 |
|  | <p>Nr. articol: 216-131 Ferrule; Sleeve for 0.25 mm² / AWG 24; uninsulated; electro-tin plated</p> | www.wago.com/216-131 |
|  | <p>Nr. articol: 216-132 Ferrule; Sleeve for 0.34 mm² / AWG 24; uninsulated; electro-tin plated</p> | www.wago.com/216-132 |
|  | <p>Nr. articol: 216-141 Ferrule; Sleeve for 0.5 mm² / 20 AWG; uninsulated; electro-tin plated; electrolytic copper; gastight crimped; acc. to DIN 46228, Part 1/08.92</p> | www.wago.com/216-141 |
|  | <p>Nr. articol: 216-142 Ferrule; Sleeve for 0.75 mm² / 18 AWG; uninsulated; electro-tin plated; electrolytic copper; gastight crimped; acc. to DIN 46228, Part 1/08.92</p> | www.wago.com/216-142 |

Supus modificărilor.

WAGO Kontakttechnik GmbH & Co. KG
/Representative Office Romania
Sos. Pipera-Tunari nr. 1/1
building 1, 2nd floor | 077190 Voluntari, Ilfov
Tel.: +40-(0)31 421 85 68 | Email: info-RO@wago.com











Aveți întrebări despre produsele noastre?
Vă stăm la dispoziție pentru preluarea apelului la +40 (0) 31 421 85 68.

| | | |
|---|---|--|
|  | Nr. articol: 216-143 Ferrule; Sleeve for 1 mm ² / AWG 18; uninsulated; electro-tin plated; electrolytic copper; gastight crimped; acc. to DIN 46228, Part 1/08.92 | www.wago.com/216-143 |
|  | Nr. articol: 216-144 Ferrule; Sleeve for 1.5 mm ² / AWG 16; uninsulated; electro-tin plated; electrolytic copper; gastight crimped; acc. to DIN 46228, Part 1/08.92 | www.wago.com/216-144 |
|  | Nr. articol: 216-151 Ferrule; Sleeve for 0.25 mm ² / AWG 24; uninsulated; electro-tin plated | www.wago.com/216-151 |
|  | Nr. articol: 216-152 Ferrule; Sleeve for 0.34 mm ² / AWG 24; uninsulated; electro-tin plated | www.wago.com/216-152 |
|  | Nr. articol: 216-221 Ferrule; Sleeve for 0.5 mm ² / 20 AWG; insulated; electro-tin plated; white | www.wago.com/216-221 |
|  | Nr. articol: 216-222 Ferrule; Sleeve for 0.75 mm ² / 18 AWG; insulated; electro-tin plated; gray | www.wago.com/216-222 |
|  | Nr. articol: 216-223 Ferrule; Sleeve for 1 mm ² / AWG 18; insulated; electro-tin plated; red | www.wago.com/216-223 |
|  | Nr. articol: 216-224 Ferrule; Sleeve for 1.5 mm ² / AWG 16; insulated; electro-tin plated; black | www.wago.com/216-224 |
|  | Nr. articol: 216-241 Ferrule; Sleeve for 0.5 mm ² / 20 AWG; insulated; electro-tin plated; electrolytic copper; gastight crimped; acc. to DIN 46228, Part 4/09.90; white | www.wago.com/216-241 |
|  | Nr. articol: 216-242 Ferrule; Sleeve for 0.75 mm ² / 18 AWG; insulated; electro-tin plated; electrolytic copper; gastight crimped; acc. to DIN 46228, Part 4/09.90; gray | www.wago.com/216-242 |
|  | Nr. articol: 216-243 Ferrule; Sleeve for 1 mm ² / AWG 18; insulated; electro-tin plated; electrolytic copper; gastight crimped; acc. to DIN 46228, Part 4/09.90; red | www.wago.com/216-243 |
|  | Nr. articol: 216-244 Ferrule; Sleeve for 1.5 mm ² / AWG 16; insulated; electro-tin plated; electrolytic copper; gastight crimped; acc. to DIN 46228, Part 4/09.90; black | www.wago.com/216-244 |
|  | Nr. articol: 216-246 Ferrule; Sleeve for 2.5 mm ² / AWG 14; insulated; electro-tin plated; electrolytic copper; gastight crimped; acc. to DIN 46228, Part 4/09.90; blue | www.wago.com/216-246 |
|  | Nr. articol: 216-262 Ferrule; Sleeve for 0.75 mm ² / 18 AWG; insulated; electro-tin plated; electrolytic copper; gastight crimped; acc. to DIN 46228, Part 4/09.90; gray | www.wago.com/216-262 |
|  | Nr. articol: 216-263 Ferrule; Sleeve for 1 mm ² / AWG 18; insulated; electro-tin plated; electrolytic copper; gastight crimped; acc. to DIN 46228, Part 4/09.90; red | www.wago.com/216-263 |
|  | Nr. articol: 216-264 Ferrule; Sleeve for 1.5 mm ² / AWG 16; insulated; electro-tin plated; electrolytic copper; gastight crimped; acc. to DIN 46228, Part 4/09.90; black | www.wago.com/216-264 |
| | Nr. articol: 216-284 | |

















Supus modificărilor.

WAGO Kontakttechnik GmbH & Co. KG
/Representative Office Romania
Sos. Pipera-Tunari nr. 1/1
building 1, 2nd floor | 077190 Voluntari, Ilfov
Tel.: +40-(0)31 421 85 68 | Email: info-RO@wago.com

Aveți întrebări despre produsele noastre?
Vă stăm la dispoziție pentru preluarea apelului la +40 (0) 31 421 85 68.

| | | |
|--|---|--|
|  | Ferrule; Sleeve for 1.5 mm ² / AWG 16; insulated; electro-tin plated; electrolytic copper; gastight crimped; acc. to DIN 46228, Part 4/09.90; black | www.wago.com/216-284 |
| | Nr. articol: 216-321 Ferrule; Sleeve for 0.25 mm ² / AWG 24; insulated; electro-tin plated; yellow | www.wago.com/216-321 |
|  | Nr. articol: 216-322 Ferrule; Sleeve for 0.34 mm ² / 22 AWG; insulated; electro-tin plated; green | www.wago.com/216-322 |
| Jumper | | |
|  | Nr. articol: 231-902 Comb-style jumper bar; for 5 mm and 5.08 mm pin spacing; reduces conductor size to 1.5 mm; gray | www.wago.com/231-902 |
|  | Nr. articol: 231-903 Comb-style jumper bar; 3-way; suitable for 231 Series female connectors; with 5 mm pin spacing; insulated; gray | www.wago.com/231-903 |
|  | Nr. articol: 231-905 Comb-style jumper bar; 5-way; suitable for 231 Series female connectors; with 5 mm pin spacing; insulated; gray | www.wago.com/231-905 |
|  | Nr. articol: 231-907 Comb-style jumper bar; 7-way; suitable for 231 Series female connectors; with 5 mm pin spacing; insulated; gray | www.wago.com/231-907 |
|  | Nr. articol: 231-910 Comb-style jumper bar; 10-way; suitable for 231 Series female connectors; with 5 mm pin spacing; insulated; gray | www.wago.com/231-910 |
| Marking accessories | | |
| | Nr. articol: 210-332/500-202 Marking strips; as a DIN A4 sheet; MARKED; 1-16 (160x); Height of marker strip: 3 mm; Strip length 182 mm; Horizontal marking; Self-adhesive; white | www.wago.com/210-332/500-202 |
| | Nr. articol: 210-332/500-204 Marking strips; as a DIN A4 sheet; MARKED; 17-32 (160x); Height of marker strip: 3 mm; Strip length 182 mm; Horizontal marking; Self-adhesive; white | www.wago.com/210-332/500-204 |
| | Nr. articol: 210-332/500-205 Marking strips; as a DIN A4 sheet; MARKED; 1-32 (80x); Height of marker strip: 3 mm; Strip length 182 mm; Horizontal marking; Self-adhesive; white | www.wago.com/210-332/500-205 |
| | Nr. articol: 210-332/500-206 Marking strips; as a DIN A4 sheet; MARKED; 33-48 (160x); Height of marker strip: 3 mm; Strip length 182 mm; Horizontal marking; Self-adhesive; white | www.wago.com/210-332/500-206 |
|  | Nr. articol: 210-833 Marking strips; on reel; 6 mm wide; plain; Self-adhesive; white | www.wago.com/210-833 |
|  | Nr. articol: 210-834 Marking strips; on reel; 5 mm wide; plain; Self-adhesive; white | www.wago.com/210-834 |
| check | | |
|  | Nr. articol: 210-136 Test plug; 2 mm Ø; with 500 mm cable; red | www.wago.com/210-136 |

Supus modificărilor.

| | | |
|--|--|--|
|  | Nr. articol: 210-137 Test plug; 2.3 mm Ø; with 500 mm cable; yellow | www.wago.com/210-137 |
|  | Nr. articol: 231-661 Test plugs for female connectors; for 5 mm and 5.08 mm pin spacing; 2,50 mm ² ; light gray | www.wago.com/231-661 |
| tools | | |
|  | Nr. articol: 209-130 Operating tool; suitable for 264, 280 and 281 Series; 1-way; of insulating material | www.wago.com/209-130 |
|  | Nr. articol: 210-657 Operating tool; Blade: 3.5 x 0.5 mm; with a partially insulated shaft; short | www.wago.com/210-657 |
|  | Nr. articol: 210-720 Operating tool; Blade: 3.5 x 0.5 mm; with a partially insulated shaft | www.wago.com/210-720 |
|  | Nr. articol: 231-131 Push-button; loose | www.wago.com/231-131 |
|  | Nr. articol: 231-159 Operating tool; natural | www.wago.com/231-159 |
|  | Nr. articol: 231-231 Combination operating tool; red | www.wago.com/231-231 |
|  | Nr. articol: 231-291 Operating tool; loose; red | www.wago.com/231-291 |
|  | Nr. articol: 280-432 Operating tool; made of insulating material; 2-way | www.wago.com/280-432 |
|  | Nr. articol: 280-433 Operating tool; made of insulating material; 3-way | www.wago.com/280-433 |
|  | Nr. articol: 280-434 Operating tool; made of insulating material; 4-way | www.wago.com/280-434 |
|  | Nr. articol: 280-435 Operating tool; made of insulating material; 5-way; gray | www.wago.com/280-435 |
|  | Nr. articol: 280-436 Operating tool; made of insulating material; 6-way | www.wago.com/280-436 |
|  | Nr. articol: 280-437 Operating tool; made of insulating material; 7-way | www.wago.com/280-437 |
|  | Nr. articol: 280-438 Operating tool; made of insulating material; 8-way | www.wago.com/280-438 |
|  | Nr. articol: 280-440 Operating tool; made of insulating material; 10-way | www.wago.com/280-440 |

Strain relief plate

Nr. articol: 232-612

Supus modificărilor.



Strain relief housing; gray

www.wago.com/232-612

assembling



Nr. articol: 209-147

Self-tapping screw

www.wago.com/209-147

Nr. articol: 231-194

Self-tapping screw; B 2.2x13, fixing hole 1.8 mm Ø

www.wago.com/231-194

Nr. articol: 231-195

Screw with nut; M2x12; for fixing element

www.wago.com/231-195

Nr. articol: 231-295

Screw with nut

www.wago.com/231-295

Descărcări

Documentation

Additional Information

Technical explanations

Apr 3, 2019

pdf
3,6 MB

Descărcare

CAD/CAE-Data

CAD data

2D/3D Models 731-512/031-000

URL

Descărcare

CAE data

EPLAN Data Portal 731-512/031-000

URL

Descărcare

Installation Notes

Application

Supus modificărilor.

WAGO Kontakttechnik GmbH & Co. KG
/Representative Office Romania
Sos. Pipera-Tunari nr. 1/1
building 1, 2nd floor | 077190 Voluntari, Ilfov
Tel.: +40-(0)31 421 85 68 | Email: info-RO@wago.com

Aveți întrebări despre produsele noastre?
Vă stăm la dispoziție pentru preluarea apelului la +40 (0) 31 421 85 68.



Angled female plug – a male header with straight solder pins is used for horizontal PCB mounting in narrow housings.

Application



Angled female connector used as through-panel connector.

Termination ports and operating slots are located outside the housing – panel thickness up to 2 mm.

Familie de produse

<i>MCS</i> MIDI Classic

Afișare globală produse din familie.

Supus modificărilor.