

Fișă tehnică | Număr articol: 2091-1424/200-000/997-406

THR male header; 1.0 mm Ø solder pin; angled; in tape-and-reel packaging;

Pin spacing 3.5 mm; 4-pole; light gray

www.wago.com/2091-1424/200-000/997-406

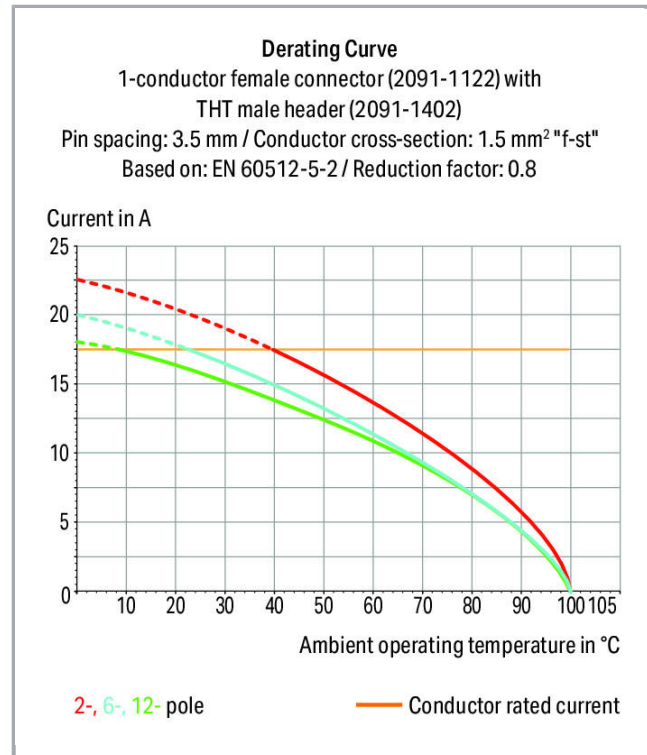
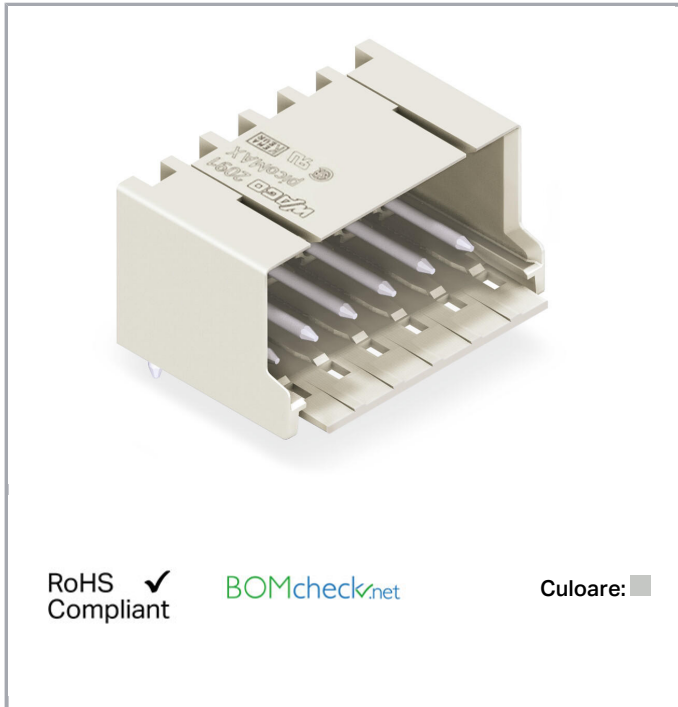

Supus modificărilor.

WAGO Kontakttechnik GmbH & Co. KG
/Representative Office Romania
Sos. Pipera-Tunari nr. 1/1
building 1, 2nd floor | 077190 Voluntari, Ilfov
Tel.: +40-(0)31 421 85 68 | Email: info-RO@wago.com

Aveți întrebări despre produsele noastre?
Vă stăm la dispoziție pentru preluarea apelului la +40 (0) 31 421 85 68.

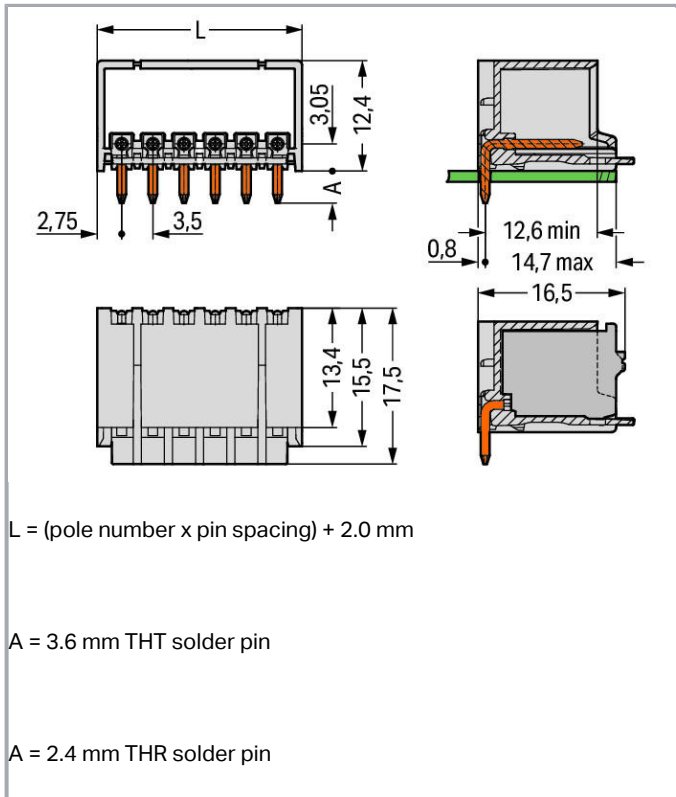

Descriere articol

- Assembly of female connectors without loss of poles, allowing different functions to be divided within one male header
- Coding pins inserted into the header interface prevent mismatching, allowing subsequent coding in panel feedthrough applications
- The female connector is fully shrouded by the male header's housing, providing vibration resistance up to 20 g

Safety information 1:

The **picoMAX® Pluggable Connection System** includes connectors without breaking capacity in accordance with DIN EN 61984. When used as intended, these connectors must not be connected/disconnected when live or under load. The circuit design should ensure header pins, which can be touched, are not live when unmated.

Date

Electrical data

Ratings per IEC/EN 60664-1

Ratings per	IEC/EN 60664-1
Nominal voltage (III/3)	160 V
Rated surge voltage (III/3)	2,5 kV

Supus modificărilor.

WAGO Kontakttechnik GmbH & Co. KG
 /Representative Office Romania
 Sos. Pipera-Tunari nr. 1/1
 building 1, 2nd floor | 077190 Voluntari, Ilfov
 Tel.: +40-(0)31 421 85 68 | Email: info-RO@wago.com

Aveți întrebări despre produsele noastre?
 Vă stăm la dispoziție pentru preluarea apelului la +40 (0) 31 421 85 68.



Rated voltage (III/2)	160 V
Rated surge voltage (III/2)	2,5 kV
Nominal voltage (II/2)	320 V
Rated surge voltage (II/2)	2,5 kV
Rated current	10 A
Legend (ratings)	(III / 2) \triangleq Overvoltage category III / Pollution degree 2

Approvals per UL 1059

Rated voltage UL (Use Group B)	300 V
Rated current UL (Use Group B)	10 A
Rated voltage UL (Use Group D)	300 V
Rated current UL (Use Group D)	10 A
Approvals per	UL 1059

Connection data

Pole No.	4
Total number of potentials	4
Number of connection types	1
Number of levels	1

Geometrical Data

Pin spacing	3,5 mm / 0.138 inch
Width	16 mm / 0.63 inch
Height	14,8 mm / 0.583 inch
Height from the surface	12,4 mm / 0.488 inch
Depth	17,5 mm / 0.689 inch
Solder pin length	2,4 mm
Solder pin diameter	1 mm
Plated through-hole diameter (THR)	1,2 ^(+0,1) mm

Plug connection

Contact type (pluggable connector)	Male connector/plug
Connector (connection type)	for PCB
Mismating protection	No
Mating direction to the PCB	0°
Locking of plug-in connection	Locking latch

Supus modificărilor.

WAGO Kontakttechnik GmbH & Co. KG
 /Representative Office Romania
 Sos. Pipera-Tunari nr. 1/1
 building 1, 2nd floor | 077190 Voluntari, Ilfov
 Tel.: +40-(0)31 421 85 68 | Email: info-RO@wago.com

Aveți întrebări despre produsele noastre?
 Vă stăm la dispoziție pentru preluarea apelului la +40 (0) 31 421 85 68.

PCB contact

PCB contact	THR
-------------	-----

Material Data

Color	light gray
Material group	I
Insulation material	Polyphthalamide (PPA GF)
Flammability class per UL94	V0
Contact material	Electrolytic copper (E _{Cu})
Contact plating	tin-plated
Weight	1,5 g

Environmental Requirements

Limit temperature range	-60 ... +100 °C
-------------------------	-----------------

Commercial data

Packaging type	bag
Country of origin	DE
GTIN	4055143031899
Customs tariff number	85366990990

Aprobări / certificate

Country specific Approvals

Emblemă	Aprobare	Text de aprobare suplimentar	Nume certificat
	CSA DEKRA Certification B.V.	C22.2	2362521

UL-Approvals

Emblemă	Aprobare	Text de aprobare suplimentar	Nume certificat
	UL Underwriters Laboratories Inc.	UL 1977	20190909- E45171

Supus modificărilor.

WAGO Kontakttechnik GmbH & Co. KG
/Representative Office Romania
Sos. Pipera-Tunari nr. 1/1
building 1, 2nd floor | 077190 Voluntari, Ilfov
Tel.: +40-(0)31 421 85 68 | Email: info-RO@wago.com

Aveți întrebări despre produsele noastre?
Vă stăm la dispoziție pentru preluarea apelului la +40 (0) 31 421 85 68.

Counterpart



Nr. articol 2091-1124

1-conductor female plug; 1.5 mm²; Pin spacing 3.5 mm; 4-pole; 1,50 mm²; light gray

www.wago.com/2091-1124

Produse compatibile

Coding



Nr. articol: 2091-1610

Coding key carrier; suitable for 3.5 mm pin spacing; orange

www.wago.com/2091-1610

Descărcări

Documentation

Additional Information

Technical explanations

Apr 3, 2019

pdf
3,6 MB

Descărcare

Installation Notes

Coding

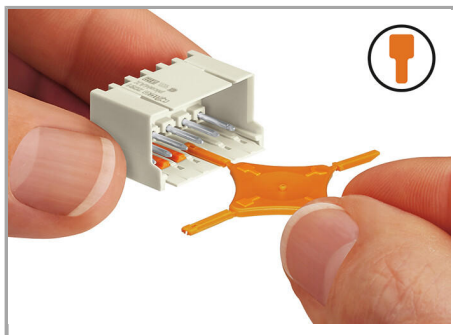

Coding a male header (via coding key carrier and two keys for male header, see symbol).

Familie de produse

picoMAX

[Afișare globală produse din familie.](#)

Supus modificărilor.