

## Fișă tehnică | Număr articol: 279-836

4-conductor through terminal block; 1.5 mm<sup>2</sup>; center marking; for DIN-rail 35 x 15 and 35 x 7.5; CAGE CLAMP®; 1,50 mm<sup>2</sup>; yellow

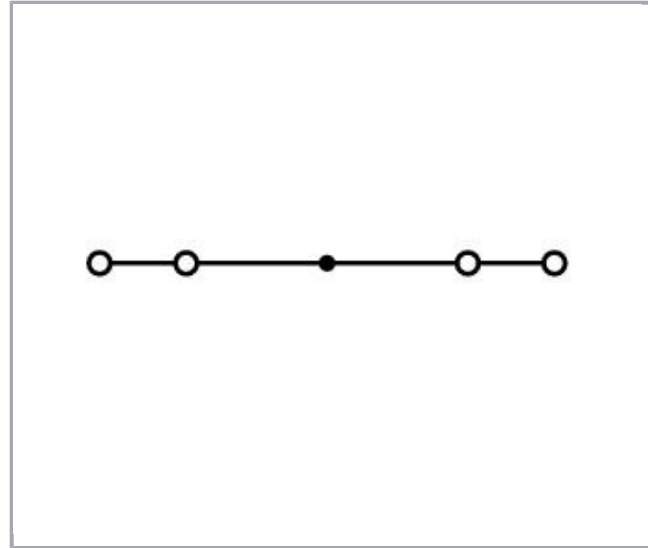

[www.wago.com/279-836](http://www.wago.com/279-836)

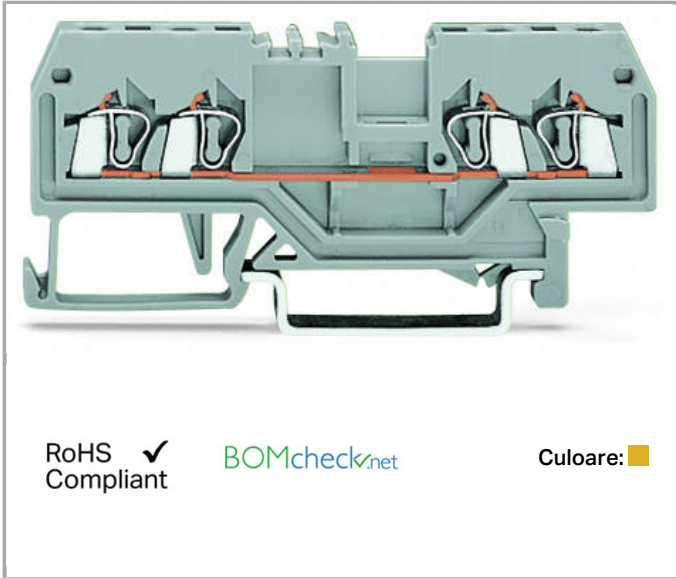

### Date

#### Electrical data

#### Ratings per IEC/EN 60664-1

Ratings per	IEC/EN 60947-7-1
Nominal voltage (III/3)	800 V
Rated surge voltage (III/3)	8 kV
Rated current	18 A
Legend (ratings)	(III / 3) ≙ Overvoltage category III / Pollution degree 3

#### Connection data

Connection technology	CAGE CLAMP®
Actuation type	Operating tool
Connectable conductor materials	Copper
Solid conductor	0,08 ... 1,5 mm <sup>2</sup> / 28 ... 16 AWG
Fine-stranded conductor	0,08 ... 1,5 mm <sup>2</sup> / 28 ... 16 AWG
Strip length	8 ... 9 mm / 0.31 ... 0.35 inch
Total number of connection points	4

Supus modificărilor.

WAGO Kontakttechnik GmbH & Co. KG  
/Representative Office Romania  
Sos. Pipera-Tunari nr. 1/1  
building 1, 2nd floor | 077190 Voluntari, Ilfov  
Tel.: +40-(0)31 421 85 68 | Email: info-RO@wago.com

Aveți întrebări despre produsele noastre?  
Vă stăm la dispoziție pentru preluarea apelului la +40 (0) 31 421 85 68.

Total number of potentials	1
Number of levels	1
Wiring type	Front-entry wiring

### Geometrical Data

Width	4 mm / 0.157 inch
Height from upper-edge of DIN-rail	27 mm / 1.063 inch
Depth	73 mm / 2.874 inch

### Mechanical data

Design	horizontal
Mounting type	DIN-35 rail
Marking level	Center marking

### Material Data



Color	yellow
Insulation material	Polyamide 66 (PA 66)
Fire load	0,116 MJ
Weight	6,3 g

### Commercial data

Packaging type	BOX
Country of origin	DE
GTIN	4044918520645
Customs tariff number	85369010000

### Aprobări / certificate

#### Country specific Approvals

Emblemă	Aprobare	Text de aprobare suplimentar	Nume certificat
	CCA DEKRA Certification B.V.	EN 60947	NTR NL- 7081
	CSA DEKRA Certification B.V.	C22.2 No. 158	70133738

Supus modificărilor.







KEMA/KEUR  
DEKRA Certification B.V.

EN 60947

2160584.04

## Ship Approvals

Emblemă	Aprobare	Text de aprobare suplimentar	Nume certificat
	<b>ABS</b> American Bureau of Shipping	-	20- HG1941090- PDA
	<b>BV</b> Bureau Veritas S.A.	EN 60947	07436/E0 BV
	<b>DNV GL</b> Det Norske Veritas, Germanischer Lloyd	-	TAE00001V2
	<b>LR</b> Lloyds Register	EN 60947	91/20112 (E9)

## UL-Approvals

Emblemă	Aprobare	Text de aprobare suplimentar	Nume certificat
	<b>UR</b> Underwriters Laboratories Inc.	UL 1059	E45172

## Counterpart

## Produse compatibile

Supus modificărilor.

WAGO Kontakttechnik GmbH & Co. KG  
/Representative Office Romania  
Sos. Pipera-Tunari nr. 1/1  
building 1, 2nd floor | 077190 Voluntari, Ilfov  
Tel.: +40-(0)31 421 85 68 | Email: info-RO@wago.com

Aveți întrebări despre produsele noastre?  
Vă stăm la dispoziție pentru preluarea apelului la +40 (0) 31 421 85 68.

## Protective Warning Marker

	<b>Nr. articol: 279-415</b> Protective warning marker; with high-voltage symbol, black; for 5 terminal blocks; yellow	<a href="http://www.wago.com/279-415">www.wago.com/279-415</a>
--	--	--

## Insulation stop

	<b>Nr. articol: 279-470</b> Insulation stop; 0.08 - 0.2 mm <sup>2</sup> "s" (0.14 mm <sup>2</sup> "f-st"); 5 pieces/strip; white	<a href="http://www.wago.com/279-470">www.wago.com/279-470</a>
--	---	--

	<b>Nr. articol: 279-471</b> Insulation stop; 0.25 mm <sup>2</sup> ; 5 pieces/strip; dark gray	<a href="http://www.wago.com/279-471">www.wago.com/279-471</a>
--	--	--

## tools

	<b>Nr. articol: 210-647</b> Operating tool; Blade: 2.5 x 0.4 mm; with a partially insulated shaft	<a href="http://www.wago.com/210-647">www.wago.com/210-647</a>
--	--	--

	<b>Nr. articol: 210-648</b> Operating tool; Blade: 2.5 x 0.4 mm; with a partially insulated shaft; angled; short	<a href="http://www.wago.com/210-648">www.wago.com/210-648</a>
--	---	--

	<b>Nr. articol: 210-719</b> Operating tool; Blade: 2.5 x 0.4 mm; with a partially insulated shaft	<a href="http://www.wago.com/210-719">www.wago.com/210-719</a>
--	--	--

## Jumper

	<b>Nr. articol: 210-103</b> Wire commoning chain; insulated; 50 connections; black	<a href="http://www.wago.com/210-103">www.wago.com/210-103</a>
--	---	--

	<b>Nr. articol: 249-123</b> Push-in type wire jumper; insulated; wire length 180 mm; Conductor cross section 0.75 mm <sup>2</sup>	<a href="http://www.wago.com/249-123">www.wago.com/249-123</a>
--	--	--

	<b>Nr. articol: 249-125</b> Push-in type wire jumper; insulated; wire length 60 mm; Conductor cross section 0.75 mm <sup>2</sup>	<a href="http://www.wago.com/249-125">www.wago.com/249-125</a>
--	---	--

	<b>Nr. articol: 249-126</b> Push-in type wire jumper; insulated; wire length 110 mm; Conductor cross section 0.75 mm <sup>2</sup>	<a href="http://www.wago.com/249-126">www.wago.com/249-126</a>
--	--	--

	<b>Nr. articol: 249-127</b> Push-in type wire jumper; insulated; wire length 250 mm; Conductor cross section 0.75 mm <sup>2</sup>	<a href="http://www.wago.com/249-127">www.wago.com/249-127</a>
--	--	--

	<b>Nr. articol: 279-402</b> Adjacent jumper; insulated; Nominal current 15 A; gray	<a href="http://www.wago.com/279-402">www.wago.com/279-402</a>
--	---	--

	<b>Nr. articol: 279-409</b> Alternate jumper; insulated; Nominal current 15 A; gray	<a href="http://www.wago.com/279-409">www.wago.com/279-409</a>
--	--	--

	<b>Nr. articol: 279-422</b> Adjacent jumper; insulated; Nominal current 15 A; yellow-green	<a href="http://www.wago.com/279-422">www.wago.com/279-422</a>
--	---	--

	<b>Nr. articol: 279-482</b> Comb-style jumper bar; insulated; 2-way; IN = IN terminal block; gray	<a href="http://www.wago.com/279-482">www.wago.com/279-482</a>
--	--	--

Supus modificărilor.

**Nr. articol: 279-483**

Comb-style jumper bar; insulated; 3-way; IN = IN terminal block; gray

[www.wago.com/279-483](http://www.wago.com/279-483)**Nr. articol: 279-490**

Comb-style jumper bar; insulated; 10-way; IN = IN terminal block; gray

[www.wago.com/279-490](http://www.wago.com/279-490)**Nr. articol: 279-492**

Alternate comb-style jumper bar; insulated; 2-way; IN = IN terminal block; gray

[www.wago.com/279-492](http://www.wago.com/279-492)**Nr. articol: 284-414**Step-down jumper; insulated; from 10/6 mm<sup>2</sup> to 4/2.5/1.5 mm<sup>2</sup>; Nominal current 15 A; gray[www.wago.com/284-414](http://www.wago.com/284-414)**Marking accessories****Nr. articol: 2009-114**

WMB-Inline; for Smart Printer; 2000 pieces on roll; stretchable 4 - 4.2 mm; plain; snap-on type; white

[www.wago.com/2009-114](http://www.wago.com/2009-114)**Nr. articol: 2009-114/000-002**

WMB-Inline; for Smart Printer; 2000 pieces on roll; stretchable 4 - 4.2 mm; plain; snap-on type; yellow

[www.wago.com/2009-114/000-002](http://www.wago.com/2009-114/000-002)**Nr. articol: 2009-114/000-005**

WMB-Inline; for Smart Printer; 2000 pieces on roll; stretchable 4 - 4.2 mm; plain; snap-on type; red

[www.wago.com/2009-114/000-005](http://www.wago.com/2009-114/000-005)**Nr. articol: 2009-114/000-006**

WMB-Inline; for Smart Printer; 2000 pieces on roll; stretchable 4 - 4.2 mm; plain; snap-on type; blue

[www.wago.com/2009-114/000-006](http://www.wago.com/2009-114/000-006)**Nr. articol: 2009-114/000-007**

WMB-Inline; for Smart Printer; 2000 pieces on roll; stretchable 4 - 4.2 mm; plain; snap-on type; gray

[www.wago.com/2009-114/000-007](http://www.wago.com/2009-114/000-007)**Nr. articol: 2009-114/000-012**

WMB-Inline; for Smart Printer; 2000 pieces on roll; stretchable 4 - 4.2 mm; plain; snap-on type; orange

[www.wago.com/2009-114/000-012](http://www.wago.com/2009-114/000-012)**Nr. articol: 2009-114/000-023**

WMB-Inline; for Smart Printer; 2000 pieces on roll; stretchable 4 - 4.2 mm; plain; snap-on type; green

[www.wago.com/2009-114/000-023](http://www.wago.com/2009-114/000-023)**Nr. articol: 2009-114/000-024**

WMB-Inline; for Smart Printer; 2000 pieces on roll; stretchable 4 - 4.2 mm; plain; snap-on type; violet

[www.wago.com/2009-114/000-024](http://www.wago.com/2009-114/000-024)**Nr. articol: 209-128**

Adaptor; gray

[www.wago.com/209-128](http://www.wago.com/209-128)**Nr. articol: 209-140**

Group marker carrier; gray

[www.wago.com/209-140](http://www.wago.com/209-140)**Nr. articol: 209-141**

Group marker carrier; gray

[www.wago.com/209-141](http://www.wago.com/209-141)

Supus modificărilor.



**Nr. articol: 209-142**  
Group marker carrier; gray

[www.wago.com/209-142](http://www.wago.com/209-142)



**Nr. articol: 209-185**  
Adaptor; gray

[www.wago.com/209-185](http://www.wago.com/209-185)



**Nr. articol: 249-105**  
Group marker carrier; gray

[www.wago.com/249-105](http://www.wago.com/249-105)



**Nr. articol: 793-4501**  
WMB marking card; as card; stretchable 4 - 4.2 mm; plain; snap-on type; white

[www.wago.com/793-4501](http://www.wago.com/793-4501)



**Nr. articol: 793-4501/000-002**  
WMB marking card; as card; stretchable 4 - 4.2 mm; plain; snap-on type; yellow

[www.wago.com/793-4501/000-002](http://www.wago.com/793-4501/000-002)



**Nr. articol: 793-4501/000-005**  
WMB marking card; as card; stretchable 4 - 4.2 mm; plain; snap-on type; red

[www.wago.com/793-4501/000-005](http://www.wago.com/793-4501/000-005)



**Nr. articol: 793-4501/000-006**  
WMB marking card; as card; stretchable 4 - 4.2 mm; plain; snap-on type; blue

[www.wago.com/793-4501/000-006](http://www.wago.com/793-4501/000-006)



**Nr. articol: 793-4501/000-007**  
WMB marking card; as card; stretchable 4 - 4.2 mm; plain; snap-on type; gray

[www.wago.com/793-4501/000-007](http://www.wago.com/793-4501/000-007)



**Nr. articol: 793-4501/000-012**  
WMB marking card; as card; stretchable 4 - 4.2 mm; plain; snap-on type; orange

[www.wago.com/793-4501/000-012](http://www.wago.com/793-4501/000-012)



**Nr. articol: 793-4501/000-014**  
WMB marking card; as card; stretchable 4 - 4.2 mm; plain; snap-on type; brown

[www.wago.com/793-4501/000-014](http://www.wago.com/793-4501/000-014)



**Nr. articol: 793-4501/000-017**  
WMB marking card; as card; stretchable 4 - 4.2 mm; plain; snap-on type; green

[www.wago.com/793-4501/000-017](http://www.wago.com/793-4501/000-017)



**Nr. articol: 793-4501/000-023**  
WMB marking card; as card; stretchable 4 - 4.2 mm; plain; snap-on type; light green

[www.wago.com/793-4501/000-023](http://www.wago.com/793-4501/000-023)



**Nr. articol: 793-4501/000-024**  
WMB marking card; as card; stretchable 4 - 4.2 mm; plain; snap-on type; violet

[www.wago.com/793-4501/000-024](http://www.wago.com/793-4501/000-024)

#### assembling



**Nr. articol: 209-106**  
Mounting carrier; for isolated mounting on DIN 35 rails; gray

[www.wago.com/209-106](http://www.wago.com/209-106)

Supus modificărilor.

**Nr. articol: 709-153**

Cover; Type 1; suitable for cover carrier, type 1; 1 m long; transparent

[www.wago.com/709-153](http://www.wago.com/709-153)**Carrier rail****Nr. articol: 210-112**

Steel carrier rail; 35 x 7.5 mm; 1 mm thick; 2 m long; slotted; according to EN 60715; "Hole width 25 mm

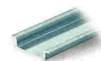
[www.wago.com/210-112](http://www.wago.com/210-112)**Nr. articol: 210-113**

Steel carrier rail; 35 x 7.5 mm; 1 mm thick; 2 m long; unslotted; according to EN 60715

[www.wago.com/210-113](http://www.wago.com/210-113)**Nr. articol: 210-114**

Steel carrier rail; 35 x 15 mm; 1.5 mm thick; 2 m long; unslotted; similar to EN 60715

[www.wago.com/210-114](http://www.wago.com/210-114)**Nr. articol: 210-115**

Steel carrier rail; 35 x 7.5 mm; 1 mm thick; 2 m long; slotted; according to EN 60715; "Hole width 18 mm

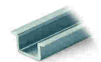
[www.wago.com/210-115](http://www.wago.com/210-115)**Nr. articol: 210-118**

Steel carrier rail; 35 x 15 mm; 2.3 mm thick; 2 m long; unslotted; according to EN 60715

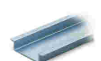
[www.wago.com/210-118](http://www.wago.com/210-118)**Nr. articol: 210-196**

Aluminum carrier rail; 35 x 8.2 mm; 1.6 mm thick; 2 m long; unslotted; similar to EN 60715; silver-colored

[www.wago.com/210-196](http://www.wago.com/210-196)**Nr. articol: 210-197**

Steel carrier rail; 35 x 15 mm; 1.5 mm thick; 2 m long; slotted; similar to EN 60715

[www.wago.com/210-197](http://www.wago.com/210-197)**Nr. articol: 210-198**

Copper carrier rail; 35 x 15 mm; 2.3 mm thick; 2 m long; unslotted; according to EN 60715; copper-colored

[www.wago.com/210-198](http://www.wago.com/210-198)**Nr. articol: 210-504**

Steel carrier rail; 35 x 7.5 mm; 1 mm thick; 2 m long; slotted; galvanized; according to EN 60715

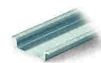
[www.wago.com/210-504](http://www.wago.com/210-504)**Nr. articol: 210-505**

Steel carrier rail; 35 x 7.5 mm; 1 mm thick; 2 m long; unslotted; galvanized; according to EN 60715

[www.wago.com/210-505](http://www.wago.com/210-505)**Nr. articol: 210-506**

Steel carrier rail; 35 x 15 mm; 1.5 mm thick; 2 m long; unslotted; galvanized; similar to EN 60715

[www.wago.com/210-506](http://www.wago.com/210-506)**Nr. articol: 210-508**















Steel carrier rail; 35 x 15 mm; 1.5 mm thick; 2 m long; slotted; galvanized; similar to EN 60715

[www.wago.com/210-508](http://www.wago.com/210-508)**check****Nr. articol: 209-170**Test plug adapter; 8.3 mm wide; for 4 mm Ø test plugs; suitable for 1.5 mm<sup>2</sup> - 10 mm<sup>2</sup> tbs; gray[www.wago.com/209-170](http://www.wago.com/209-170)**Nr. articol: 280-404**Test plug adapter; 5 mm wide; for test plug 210-137 (2.3 mm Ø); suitable for 1.5 mm<sup>2</sup> - 4 mm<sup>2</sup> tbs; gray[www.wago.com/280-404](http://www.wago.com/280-404)**End plate****Nr. articol: 279-344**

End and intermediate plate; 2 mm thick; gray

[www.wago.com/279-344](http://www.wago.com/279-344)

Supus modificărilor.

	<b>Nr. articol: 279-345</b> Separator plate; 2 mm thick; oversized; gray	<a href="http://www.wago.com/279-345">www.wago.com/279-345</a>
	<b>Nr. articol: 279-346</b> End and intermediate plate; 2 mm thick; orange	<a href="http://www.wago.com/279-346">www.wago.com/279-346</a>
	<b>Nr. articol: 279-347</b> Separator plate; 2 mm thick; oversized; orange	<a href="http://www.wago.com/279-347">www.wago.com/279-347</a>
	<b>Nr. articol: 284-334</b> Step-down cover plate; 1 mm thick; for 2-, 3- and 4-conductor terminal blocks; gray	<a href="http://www.wago.com/284-334">www.wago.com/284-334</a>
	<b>Nr. articol: 284-336</b> Step-down cover plate; 1 mm thick; for 4-conductor 279-831, 280-833 and 281-652 terminal blocks; gray	<a href="http://www.wago.com/284-336">www.wago.com/284-336</a>
	<b>Nr. articol: 284-344</b> Step-down cover plate; 1 mm thick; for 2-, 3- and 4-conductor terminal blocks; orange	<a href="http://www.wago.com/284-344">www.wago.com/284-344</a>
	<b>Nr. articol: 284-346</b> Step-down cover plate; 1 mm thick; for 4-conductor 279-831, 280-833 and 281-652 terminal blocks; orange	<a href="http://www.wago.com/284-346">www.wago.com/284-346</a>
<b>ferrule</b>		
	<b>Nr. articol: 216-101</b> Ferrule; Sleeve for 0.5 mm <sup>2</sup> / AWG 22; uninsulated; electro-tin plated	<a href="http://www.wago.com/216-101">www.wago.com/216-101</a>
	<b>Nr. articol: 216-102</b> Ferrule; Sleeve for 0.75 mm <sup>2</sup> / AWG 20; uninsulated; electro-tin plated	<a href="http://www.wago.com/216-102">www.wago.com/216-102</a>
	<b>Nr. articol: 216-103</b> Ferrule; Sleeve for 1 mm <sup>2</sup> / AWG 18; uninsulated; electro-tin plated	<a href="http://www.wago.com/216-103">www.wago.com/216-103</a>
	<b>Nr. articol: 216-201</b> Ferrule; Sleeve for 0.5 mm <sup>2</sup> / 20 AWG; insulated; electro-tin plated; white	<a href="http://www.wago.com/216-201">www.wago.com/216-201</a>
	<b>Nr. articol: 216-202</b> Ferrule; Sleeve for 0.75 mm <sup>2</sup> / 18 AWG; insulated; electro-tin plated; gray	<a href="http://www.wago.com/216-202">www.wago.com/216-202</a>
	<b>Nr. articol: 216-203</b> Ferrule; Sleeve for 1 mm <sup>2</sup> / AWG 18; insulated; electro-tin plated; red	<a href="http://www.wago.com/216-203">www.wago.com/216-203</a>
	<b>Nr. articol: 216-301</b> Ferrule; Sleeve for 0.25 mm <sup>2</sup> / AWG 24; insulated; electro-tin plated; yellow	<a href="http://www.wago.com/216-301">www.wago.com/216-301</a>
	<b>Nr. articol: 216-302</b> Ferrule; Sleeve for 0.34 mm <sup>2</sup> / 22 AWG; insulated; electro-tin plated; green	<a href="http://www.wago.com/216-302">www.wago.com/216-302</a>

## Descărcări

### Documentation

#### Additional Information

Technical explanations

Apr 3, 2019

pdf

Descărcare

Supus modificărilor.



## CAD/CAE-Data

### CAD data

2D/3D Models 279-836	<a href="#">URL</a>	<a href="#">Descărcare</a>
----------------------	---------------------	----------------------------

### CAE data

EPLAN Data Portal 279-836	<a href="#">URL</a>	<a href="#">Descărcare</a>
---------------------------	---------------------	----------------------------

WSCAD Universe 279-836	<a href="#">URL</a>	<a href="#">Descărcare</a>
------------------------	---------------------	----------------------------

## Installation Notes

### Assembly

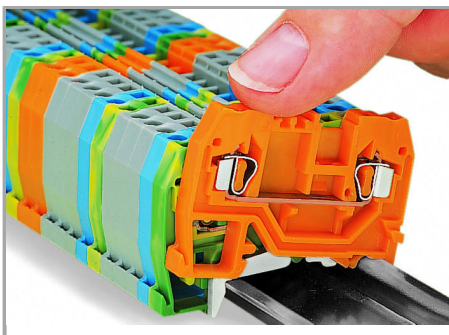

Snapping a terminal block onto the carrier rail.

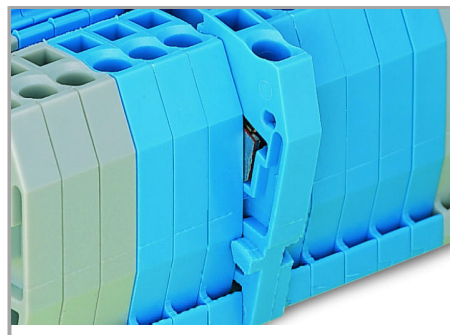

Quick assembly keys prevent reverse mounting.

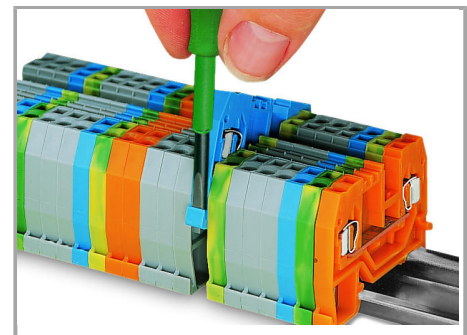

Removing a terminal block from the assembly.

### Inserting a conductor

Supus modificărilor.

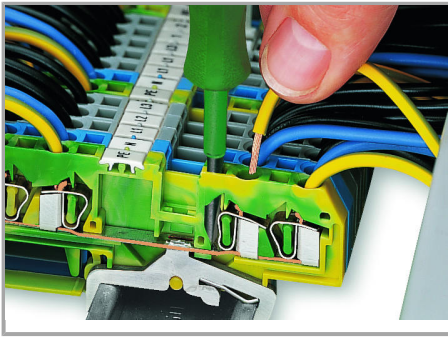

CAGE CLAMP® connection

Inserting a conductor.



CAGE CLAMP® connection

Inserting a conductor.

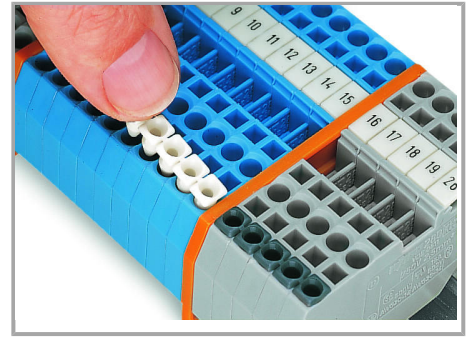

Inserting insulation stops.

With ferruled conductors, it is necessary to use a terminal block one size larger than the conductor's nominal cross-section.

#### Commoning

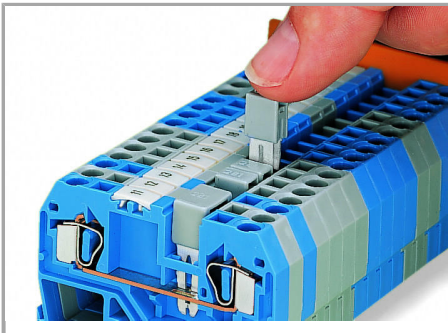

Commoning using an adjacent jumper (280-402).

Push jumper down until fully inserted.

Supus modificărilor.

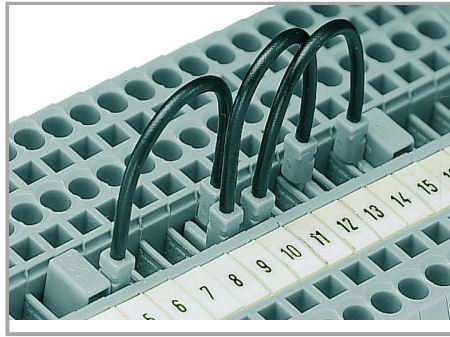

Supus modificărilor.

WAGO Kontakttechnik GmbH & Co. KG  
/Representative Office Romania  
Sos. Pipera-Tunari nr. 1/1  
building 1, 2nd floor | 077190 Voluntari, Ilfov  
Tel.: +40-(0)31 421 85 68 | Email: info-RO@wago.com

Aveți întrebări despre produsele noastre?  
Vă stăm la dispoziție pentru preluarea apelului la +40 (0) 31 421 85 68.

## Wire jumpers

When installing machines or control systems, it is often necessary to make an additional connection between two terminal blocks that are not next to each other on the rail. In such cases, WAGO's touch-proof, push-in type wire jumpers are the ideal solution.

These jumpers are compatible with the following rail-mount terminal blocks:

- 279 Series (1.5 mm<sup>2</sup>/16 AWG),
- 
- 280/775/780 Series (2.5 mm<sup>2</sup>/14 AWG)
- 
- 281/769/776/777/781 and 880 Series (4 mm<sup>2</sup>/12 AWG)
- 

They are available in three conductor lengths (60, 110 and 250 mm), allowing up to 60 terminal blocks to be commoned depending on their width (see table on the right).

Compared with the 279 Series, the 280/775/780 and 281/776/777/781 Series can also accommodate two wire jumpers, allowing the use of commoning chains. Furthermore, the 280/769/775/780/880 and 281/776/777/781 Series allow both wire jumper and adjacent jumper to be simultaneously plugged into a same terminal block.

## Testing

Supus modificărilor.

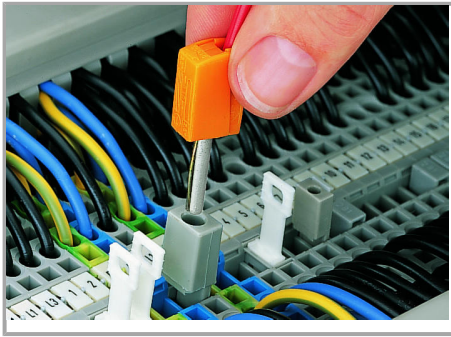

Testing with a test plug

(picture shows 209-170 Test Plug Adapter).

#### Cover

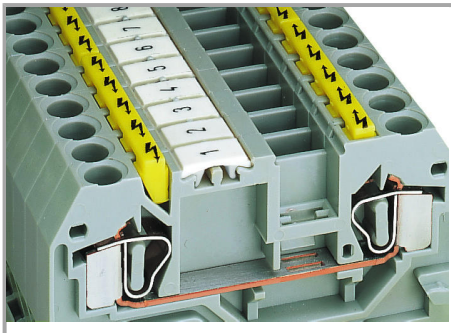

Protective warning markers inserted into the operating slots.

#### Marking

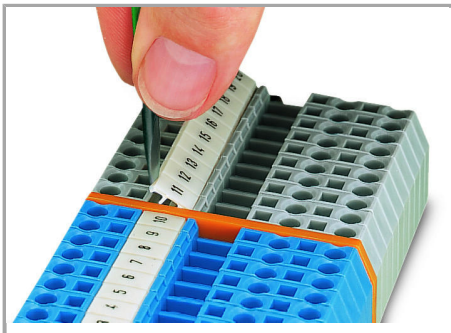

Marking via WMB Multi Marking System.

Supus modificărilor.