

Fișă tehnică | Număr articol: 231-240/001-000

THT male header; 1.0 x 1.0 mm solder pin; straight; Pin spacing 7.5 mm; 10-pole; gray

www.wago.com/231-240/001-000

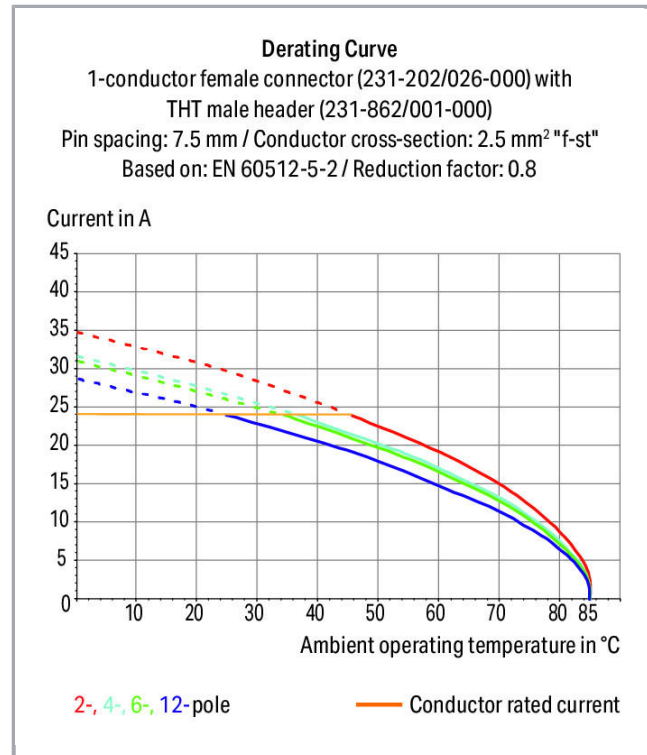
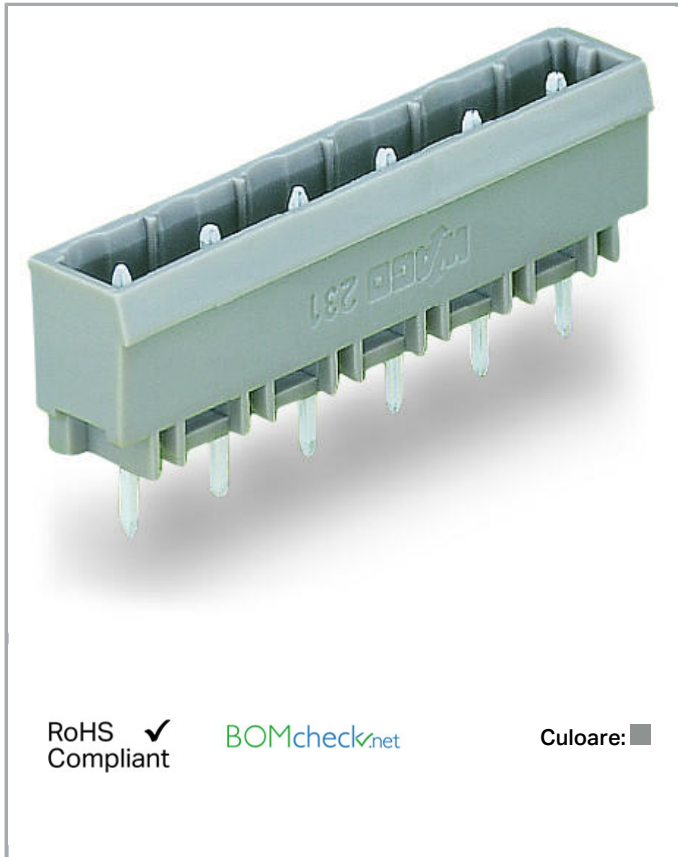

Supus modificărilor.

WAGO Kontakttechnik GmbH & Co. KG
/Representative Office Romania
Sos. Pipera-Tunari nr. 1/1
building 1, 2nd floor | 077190 Voluntari, Ilfov
Tel.: +40-(0)31 421 85 68 | Email: info-RO@wago.com

Aveți întrebări despre produsele noastre?
Vă stăm la dispoziție pentru preluarea apelului la +40 (0) 31 421 85 68.

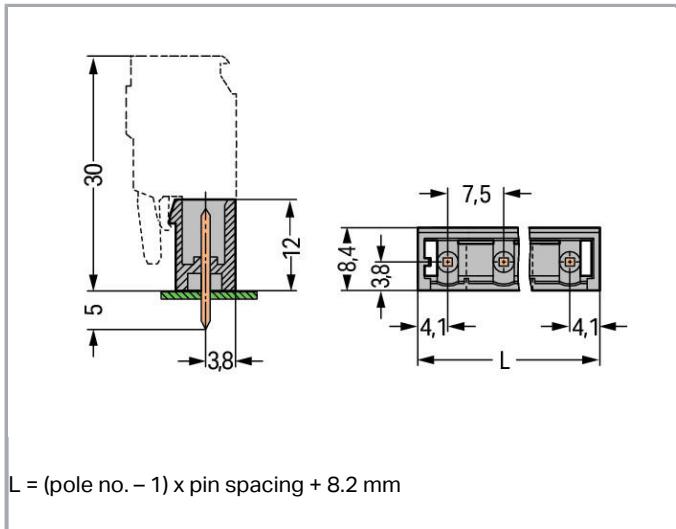

Descriere articol

- Horizontal or vertical PCB mounting via straight or angled solder pins
- Pin cross-section: 1 x 1 mm
- With coding fingers

Safety information 1:

The *MULTI CONNECTION SYSTEM (MCS)* is designed without breaking capacity for compliance with DIN EN 61984. When used as intended, MCS Connectors shall not be connected/disconnected when live or under load. The circuit design should ensure header pins, which can be touched, are not live when unmated.

Date

Electrical data

Ratings per IEC/EN 60664-1

Ratings per	IEC/EN 60664-1
Nominal voltage (III/3)	500 V
Rated surge voltage (III/3)	6 kV
Rated voltage (III/2)	630 V
Rated surge voltage (III/2)	6 kV
Nominal voltage (II/2)	1000 V
Rated surge voltage (II/2)	6 kV
Rated current	12 A
Legend (ratings)	(III / 2) ≙ Overvoltage category III / Pollution degree 2

Supus modificărilor.

WAGO Kontakttechnik GmbH & Co. KG
 /Representative Office Romania
 Sos. Pipera-Tunari nr. 1/1
 building 1, 2nd floor | 077190 Voluntari, Ilfov
 Tel.: +40-(0)31 421 85 68 | Email: info-RO@wago.com

Aveți întrebări despre produsele noastre?
 Vă stăm la dispoziție pentru preluarea apelului la +40 (0) 31 421 85 68.



Approvals per UL 1059

Rated voltage UL (Use Group B)	300 V
Rated current UL (Use Group B)	10 A
Rated voltage UL (Use Group D)	300 V
Rated current UL (Use Group D)	10 A
Approvals per	UL 1059

Approvals per UL 1977

Rated voltage UL 1977	600 V
Rated current UL 1977	10 A

Approvals per CSA

Rated voltage CSA (Use Group B)	300 V
Rated current CSA (Use Group B)	10 A
Rated voltage CSA (Use Group D)	300 V
Rated current CSA (Use Group D)	10 A

Connection data

Pole No.	10
Total number of potentials	10
Number of connection types	1
Number of levels	1

Geometrical Data

Pin spacing	7.5 mm / 0.295 inch
Width	75.7 mm / 2.98 inch
Height	17 mm / 0.669 inch
Height from the surface	12 mm / 0.472 inch
Depth	8.4 mm / 0.331 inch
Solder pin length	5 mm
Solder pin dimensions	1 x 1 mm
Drilled hole diameter with tolerance	1.4 ^(+0.1) mm

Plug connection

Contact type (pluggable connector)	Male connector/plug
------------------------------------	---------------------

Supus modificărilor.

WAGO Kontakttechnik GmbH & Co. KG
 /Representative Office Romania
 Sos. Pipera-Tunari nr. 1/1
 building 1, 2nd floor | 077190 Voluntari, Ilfov
 Tel.: +40-(0)31 421 85 68 | Email: info-RO@wago.com

Aveți întrebări despre produsele noastre?
 Vă stăm la dispoziție pentru preluarea apelului la +40 (0) 31 421 85 68.

Connector (connection type)	for PCBs
Mismating protection	No
Mating direction to the PCB	90°

PCB contact

PCB contact	THT
Solder pin arrangement	over the entire male connector, in line
Number of solder pins per potential	1

Material Data

Color	gray
Material group	I
Insulation material	Polyamide 66 (PA 66)
Flammability class per UL94	V0
Contact material	Electrolytic copper (E _{Cu})
Contact plating	tin-plated
Fire load	0,079 MJ
Weight	3,9 g

Environmental Requirements

Limit temperature range	-60 ... +100 °C
-------------------------	-----------------

Commercial data

Product Group	3 (Multi Conn. System)
Packaging type	BOX
Country of origin	PL
GTIN	4044918864909
Customs tariff number	85366990990

Aprobări / certificate

Country specific Approvals

Emblemă	Aprobare	Text de aprobare suplimentar	Nume certificat
	CSA DEKRA Certification B.V.	C22.2	1466354

Supus modificărilor.

WAGO Kontakttechnik GmbH & Co. KG
/Representative Office Romania
Sos. Pipera-Tunari nr. 1/1
building 1, 2nd floor | 077190 Voluntari, Ilfov
Tel.: +40-(0)31 421 85 68 | Email: info-RO@wago.com

Aveți întrebări despre produsele noastre?
Vă stăm la dispoziție pentru preluarea apelului la +40 (0) 31 421 85 68.





KEMA/KEUR
DEKRA Certification B.V.



EN 61984

2190761.01





Ship Approvals

Emblemă	Aprobare	Text de aprobare suplimentar	Nume certificat
	ABS American Bureau of Shipping	-	19- HG1869876- PDA
	DNV GL Det Norske Veritas, Germanischer Lloyd	-	TAE000016Z

UL-Approvals

Emblemă	Aprobare	Text de aprobare suplimentar	Nume certificat
	UL Underwriters Laboratories Inc.	UL 1059	20190731- E45172
	UR Underwriters Laboratories Inc.	UL 1977	20150318- E45171

Counterpart

	Nr. articol 231-210/026-000 1-conductor female plug; 2.5 mm ² ; Pin spacing 7.5 mm; 10-pole; 2,50 mm ² ; gray	www.wago.com/231-210/026-000
	Nr. articol 231-2210/026-000 2-conductor female connector; 2.5 mm ² ; Pin spacing 7.5 mm; 10-pole; 2,50 mm ² ; gray	www.wago.com/231-2210/026-000
	Nr. articol 231-2210/037-000 2-conductor female connector; Locking lever; 2.5 mm ² ; Pin spacing 7.5 mm; 10-pole; 2,50 mm ² ; gray	www.wago.com/231-2210/037-000
	Nr. articol 2231-210/026-000 1-conductor female plug; push-button; 2.5 mm ² ; Pin spacing 7.5 mm; 10-pole; 2,50 mm ² ; gray	www.wago.com/2231-210/026-000

Nr. articol2231-210/031-000

Supus modificărilor.

WAGO Kontakttechnik GmbH & Co. KG
/Representative Office Romania
Sos. Pipera-Tunari nr. 1/1
building 1, 2nd floor | 077190 Voluntari, Ilfov
Tel.: +40-(0)31 421 85 68 | Email: info-RO@wago.com

Aveți întrebări despre produsele noastre?
Vă stăm la dispoziție pentru preluarea apelului la +40 (0) 31 421 85 68.



1-conductor female plug; push-button; clamping collar; 2.5 mm²; Pin spacing 7.5 mm; 10-pole; 2,50 mm²; gray www.wago.com/2231-210/031-000



Nr. articol2231-210/037-000
1-conductor female plug; push-button; Locking lever; 2.5 mm²; Pin spacing 7.5 mm; 10-pole; 2,50 mm²; gray www.wago.com/2231-210/037-000



Nr. articol231-210/027-000
1-conductor female plug; clamping collar; 2.5 mm²; Pin spacing 7.5 mm; 10-pole; 2,50 mm²; gray www.wago.com/231-210/027-000



Nr. articol231-210/037-000
1-conductor female plug; Locking lever; 2.5 mm²; Pin spacing 7.5 mm; 10-pole; 2,50 mm²; gray www.wago.com/231-210/037-000



Nr. articol231-210/031-000
1-conductor female plug; clamping collar; 2.5 mm²; Pin spacing 7.5 mm; 10-pole; 2,50 mm²; gray www.wago.com/231-210/031-000



Nr. articol732-110/026-000
1-conductor female plug; angled; 2.5 mm²; Pin spacing 7.5 mm; 10-pole; 2,50 mm²; gray www.wago.com/732-110/026-000

Produse compatibile

Marking accessories



Nr. articol: 210-833
Marking strips; on reel; 6 mm wide; plain; Self-adhesive; white www.wago.com/210-833



Nr. articol: 210-834
Marking strips; on reel; 5 mm wide; plain; Self-adhesive; white www.wago.com/210-834

Coding



Nr. articol: 231-130
Coding key; snap-on type; light gray www.wago.com/231-130



Nr. articol: 231-500
Spacer; for formation of groups; light gray www.wago.com/231-500

Descărcări

Documentation

Additional Information

Technical explanations

Apr 3, 2019

pdf
3,6 MB

Descărcare

Supus modificărilor.



CAD/CAE-Data

CAD data

2D/3D Models 231-240/001-000	URL	Descărcare
------------------------------	---------------------	----------------------------

CAE data

EPLAN Data Portal 231-240/001-000	URL	Descărcare
-----------------------------------	---------------------	----------------------------

PCB Design

Symbol and Footprint 231-240/001-000	URL	Descărcare
--------------------------------------	---------------------	----------------------------

CAX data for your PCB design, consisting of "schematic symbols and PCB footprints", allow easy integration of the WAGO component into your development environment.

Supported formats:

- Accel EDA 14 & 15
- Altium 6 to current version
- Cadence Allegro
- DesignSpark
- Eagle Libraries
- KiCad
- Mentor Graphics BoardStation
- Mentor Graphics Design Architect
- Mentor Graphics Design Expedition 99 and 2000
- OrCAD 9.X PCB and Capture
- PADS PowerPCB 3, 3.5, 4.X, and 5.X
- PADS PowerPCB and PowerLogic 3.0
- PCAD 2000, 2001, 2002, 2004, and 2006
- Pulsonix 8.5 or newer
- STL
- 3D STEP
- TARGET 3001!
- View Logic ViewDraw
- Quadcept
- Zuken CadStar 3 and 4
- Zuken CR-5000 and CR-8000

PCB Component Libraries (EDA), PCB CAD Library Ultra Librarian

Supus modificărilor.

WAGO Kontakttechnik GmbH & Co. KG
/Representative Office Romania
Sos. Pipera-Tunari nr. 1/1
building 1, 2nd floor | 077190 Voluntari, Ilfov
Tel.: +40-(0)31 421 85 68 | Email: info-RO@wago.com

Aveți întrebări despre produsele noastre?
Vă stăm la dispoziție pentru preluarea apelului la +40 (0) 31 421 85 68.

Installation Notes

Coding

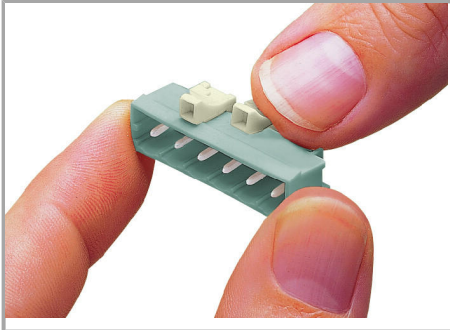

Coding a male header – fitting coding key(s).

Familie de produse

MCS MIDI Classic

Afișare globală produse din familie.

Supus modificărilor.