

Fișă tehnică | Număr articol: 770-621

T-distribution connector; 5-pole; Cod. A; 1 input; 2 outputs; 2 locking levers;
black



www.wago.com/770-621



RoHS Compliant

BOMcheck.net

Culoare: ■

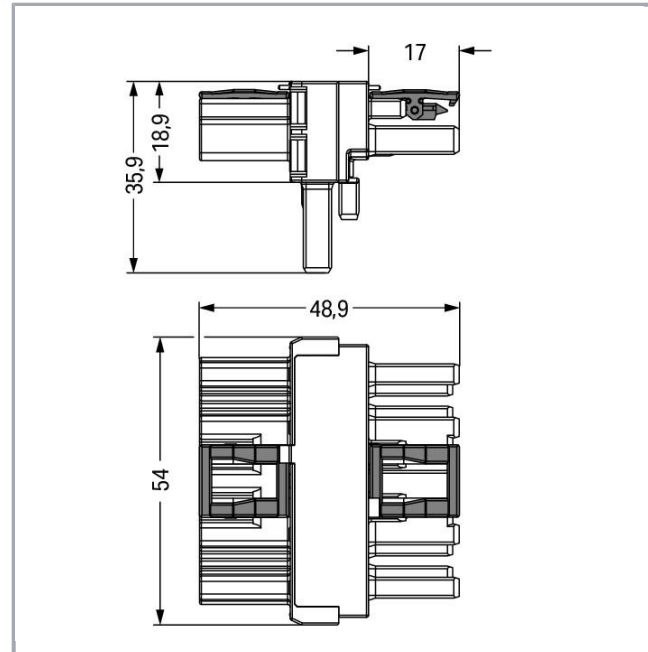

Descriere articol

- Protected against mismatching and maintenance-free
- Additional variable coding is possible

Note:

All connectors for mounted installations (snap-in versions for lighting fixtures or devices, all types of PCB and distribution connectors) are factory-equipped with locking levers to ensure plugs and sockets are securely locked. Additional locking levers are only required for flying leads (plug /socket).

Note on mismatching protection:

All WINSTA[®] components are 100% protected against mismatching when:

- plugging different numbers of poles
- plugging while rotated 180
- plugging while laterally staggered
- plugging one pole

Safety information 1:

Supus modificărilor.

WAGO Kontakttechnik GmbH & Co. KG
/Representative Office Romania
Sos. Pipera-Tunari nr. 1/1
building 1, 2nd floor | 077190 Voluntari, Ilfov
Tel.: +40-(0)31 421 85 68 | Email: info-RO@wago.com

Aveți întrebări despre produsele noastre?

Vă stăm la dispoziție pentru preluarea apelului la +40 (0) 31 421 85 68.



Application note for the U.S. market (USR): Some versions may also be used for current interruption in accordance with the UL certificate in select applications with currents below 16 A and voltages up to 600 V. For further information, please contact your local sales office.

Date

Electrical data

Note on Contact Resistance	approx. 1 mΩ of contact resistance approx. 0.25 mΩ contact transition plug/socket
----------------------------	---

Ratings per IEC/EN 60664-1

Ratings per	IEC/EN 60664-1
Nominal voltage (III/3)	400 V
Rated surge voltage (III/3)	6 kV
Rated current	25 A
Legend (ratings)	(III / 3) ≙ Overvoltage category III / Pollution degree 3

Approvals per UL 1977

Rated voltage UL 1977	600 V
Rated current UL 1977	23 A

Connection data

Pole No.	5
Total number of potentials	5
Ground function	with preceding ground contact

Geometrical Data

Pin spacing	10 mm / 0.394 inch
Width	54 mm / 2.126 inch
Height	35,9 mm / 1.413 inch
Depth	48,9 mm / 1.925 inch

Mechanical data

Coding	A
Mating force of a plug-in connection	approx. 20 ... 70 N (depending on pole number)
Retention force of a plug-in connection	When locked: > 80 N
Unmating force of a plug-in connection	when unlocked: approx. 20 ... 70 N (depending on pole number)
Number of mating cycles	200, without resistive load 100, with resistive load $I_N = 25$ A, tested

Supus modificărilor.

WAGO Kontakttechnik GmbH & Co. KG
 /Representative Office Romania
 Sos. Pipera-Tunari nr. 1/1
 building 1, 2nd floor | 077190 Voluntari, Ilfov
 Tel.: +40-(0)31 421 85 68 | Email: info-RO@wago.com

Aveți întrebări despre produsele noastre?
 Vă stăm la dispoziție pentru preluarea apelului la +40 (0) 31 421 85 68.



	(4 mm ² /AWG 12)
Distributor type	T-distribution connector
Marking	N L1 L2 L3
Protection type	IP20
Note on protection type	Only when mated (these compact connectors are not designed for use in open, easily accessible areas).
Potential marking	N L1 L2 L3
Application	General mains applications

Plug connection

Contact type (pluggable connector)	Socket/plug
Mismating protection	Yes
Locking of plug-in connection	locking lever
Locking lever	yes

Material Data

Color	black
Insulation material	Polyamide 66 (PA 66)
Contact material	Copper or copper alloy (surface-treated)
Fire load	0,425 MJ
Weight	25,4 g

Environmental Requirements

Processing temperature	-5 ... +40 °C
Continuous operating temperature	-35 ... +85 °C
Note on continuous operating temperature	Insulating parts for temperatures ≤ 105 °C

Commercial data

Packaging type	BOX
Country of origin	DE
GTIN	4044918935005
Customs tariff number	85366990990

Aprobări / certificate

Country specific Approvals

Emblemă	Aprobare	Text de aprobare suplimentar	Nume certificat

Supus modificărilor.

WAGO Kontakttechnik GmbH & Co. KG
 /Representative Office Romania
 Sos. Pipera-Tunari nr. 1/1
 building 1, 2nd floor | 077190 Voluntari, Ilfov
 Tel.: +40-(0)31 421 85 68 | Email: info-RO@wago.com

Aveți întrebări despre produsele noastre?
 Vă stăm la dispoziție pentru preluarea apelului la +40 (0) 31 421 85 68.





CCA
DEKRA Certification B.V.

EN 61535

2173495.02





Ship Approvals

Emblemă	Aprobare	Text de aprobare suplimentar	Nume certificat
	ABS American Bureau of Shipping	-	19- HG1868589- PDA
	DNV GL Det Norske Veritas, Germanischer Lloyd	-	TAE00001Z6
	LR Lloyds Register	IEC 61984	02/20050 (E6)

UL-Approvals

Emblemă	Aprobare	Text de aprobare suplimentar	Nume certificat
	cURus Underwriters Laboratories Inc.	UL 1977	E45171 Sec. 9







Counterpart

	Nr. articol770-105 Socket; with strain relief housing; 5-pole; Cod. A; 4,00 mm ² ; black	www.wago.com/770-105
	Nr. articol770-115 Plug; with strain relief housing; 5-pole; Cod. A; 4,00 mm ² ; black	www.wago.com/770-115
	Nr. articol770-205 Socket; 5-pole; Cod. A; 4,00 mm ² ; black	www.wago.com/770-205
	Nr. articol770-215 Plug; 5-pole; Cod. A; 4,00 mm ² ; black	www.wago.com/770-215

Supus modificărilor.

WAGO Kontakttechnik GmbH & Co. KG
/Representative Office Romania
Sos. Pipera-Tunari nr. 1/1
building 1, 2nd floor | 077190 Voluntari, Ilfov
Tel.: +40-(0)31 421 85 68 | Email: info-RO@wago.com

Aveți întrebări despre produsele noastre?
Vă stăm la dispoziție pentru preluarea apelului la +40 (0) 31 421 85 68.

	Nr. articol 770-315 Plug; with strain relief housing; 5-pole; Cod. A; 4,00 mm ² ; black	www.wago.com/770-315
	Nr. articol 770-305 Socket; with strain relief housing; 5-pole; Cod. A; 4,00 mm ² ; black	www.wago.com/770-305
	Nr. articol 770-405 Socket; 5-pole; Cod. A; 4,00 mm ² ; black	www.wago.com/770-405
	Nr. articol 770-415 Plug; 5-pole; Cod. A; 4,00 mm ² ; black	www.wago.com/770-415
	Nr. articol 771-9995/006-101 pre-assembled interconnecting cable; Eca; Socket/plug; 5-pole; Cod. A; H05VV-F 5G 1.5 mm ² ; 1 m; 1,50 mm ² ; black	www.wago.com/771-9995/006-101
	Nr. articol 771-9995/206-101 pre-assembled connecting cable; Eca; Plug/open-ended; 5-pole; Cod. A; H05VV-F 5G 1.5 mm ² ; 1 m; 1,50 mm ² ; black	www.wago.com/771-9995/206-101
	Nr. articol 771-9995/106-101 pre-assembled connecting cable; Eca; Socket/open-ended; 5-pole; Cod. A; H05VV-F 5G 1.5 mm ² ; 1 m; 1,50 mm ² ; black	www.wago.com/771-9995/106-101

Descărcări

CAD/CAE-Data

CAD data

2D/3D Models 770-621	URL	Descărcare
----------------------	---------------------	----------------------------

CAE data

EPLAN Data Portal 770-621	URL	Descărcare
---------------------------	---------------------	----------------------------

WSCAD Universe 770-621	URL	Descărcare
------------------------	---------------------	----------------------------

Installation Notes

Installation

Supus modificărilor.

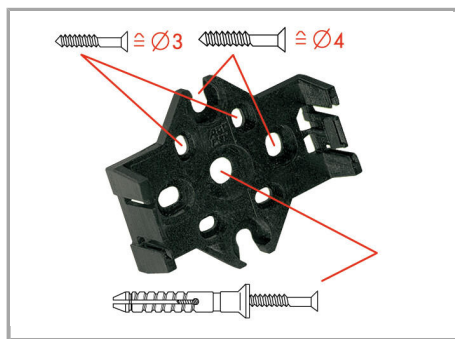

The mounting plate for distribution connectors can be mounted using commercially available screws or nail-drive anchors.



The distribution connectors are latched when mounted on the mounting plate.



To release the distribution connector, unlock the latch using a screwdriver.

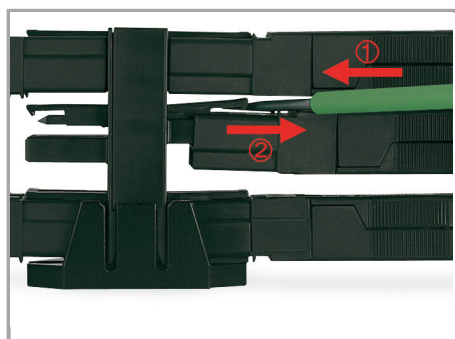

All distributor connections are locked and protected against accidental disconnection directly after mating. Locking of any connection is released using a screwdriver, even if all connections are in use.

Familie de produse

WINSTA® MIDI

Afișare globală produse din familie.

Supus modificărilor.