

## Fișă tehnică | Număr articol: 2091-1508/002-000

1-conductor male connector; Gripping plate; 1.5 mm<sup>2</sup>; Pin spacing 3.5 mm; 8-pole; 1,50 mm<sup>2</sup>; light gray

[www.wago.com/2091-1508/002-000](http://www.wago.com/2091-1508/002-000)

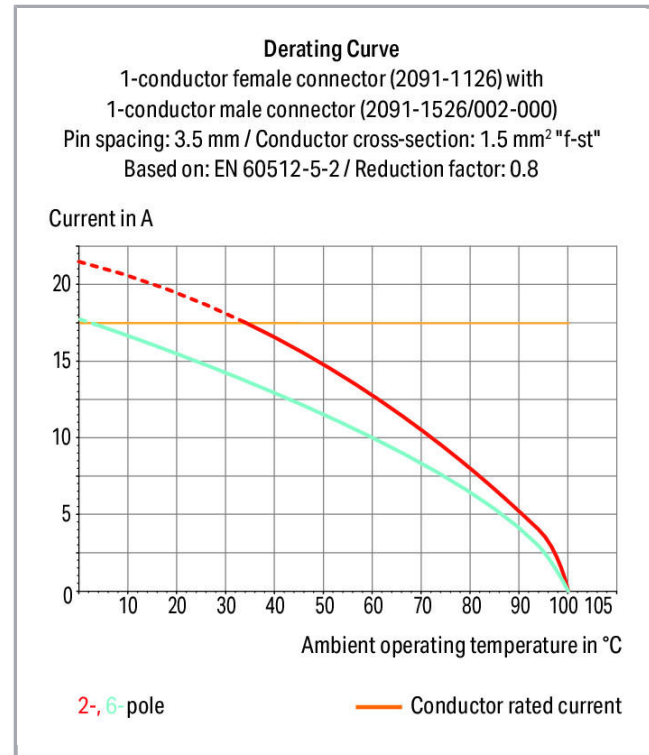
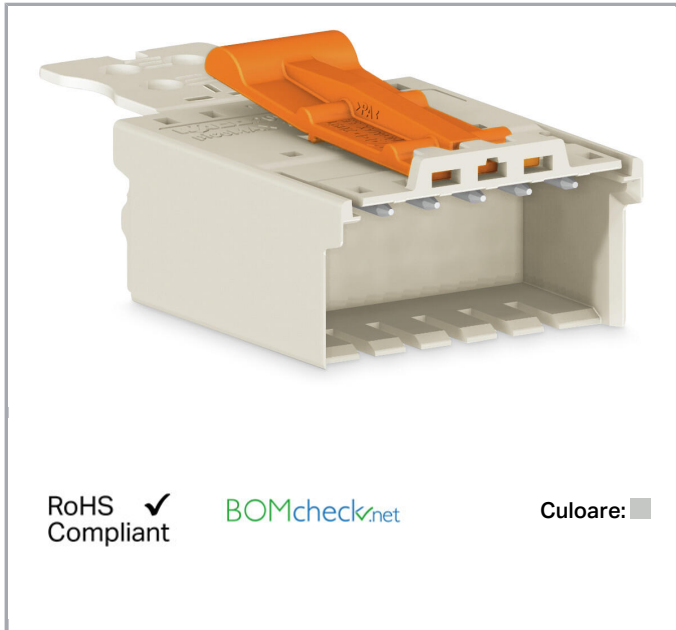

Supus modificărilor.

WAGO Kontakttechnik GmbH & Co. KG  
/Representative Office Romania  
Sos. Pipera-Tunari nr. 1/1  
building 1, 2nd floor | 077190 Voluntari, Ilfov  
Tel.: +40-(0)31 421 85 68 | Email: info-RO@wago.com

Aveți întrebări despre produsele noastre?  
Vă stăm la dispoziție pentru preluarea apelului la +40 (0) 31 421 85 68.

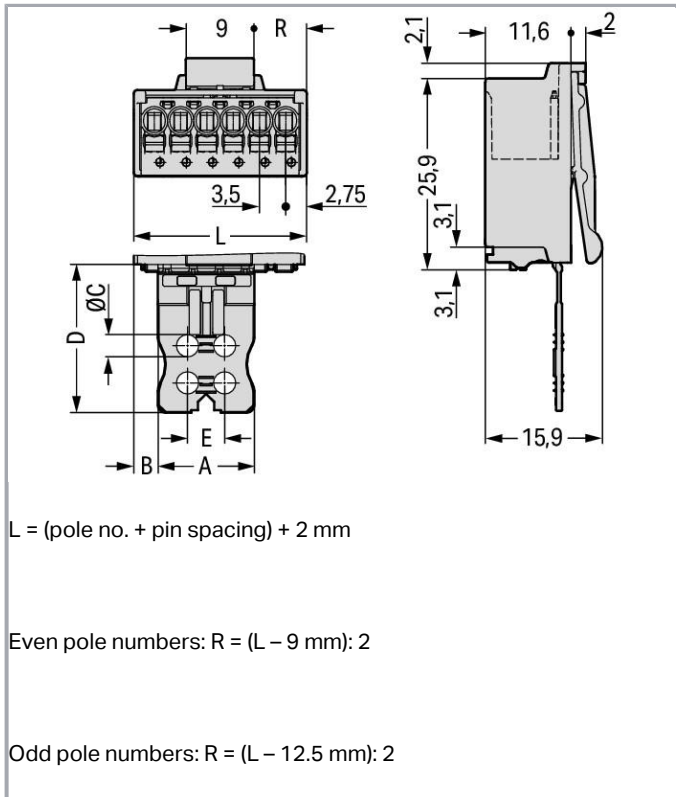

## Descriere articol

- Universal connection for all conductor types
- Simple, push-in termination of solid and ferruled conductors
- Easy-to-use design does not require special tools
- Testing parallel to conductor entry – tip contact
- For “wire-to-wire” and “board-to-wire” connections
- Integrated release lever

### Safety information 1:

The picoMAX<sup>®</sup> pluggable connection system is designed without breaking capacity for compliance with DIN EN 61984. When used as intended, MCS Connectors shall not be connected/disconnected when live or under load. The circuit design should ensure header pins, which can be touched, are not live when unmated.

## Date

### Electrical data

Supus modificărilor.

WAGO Kontakttechnik GmbH & Co. KG  
 /Representative Office Romania  
 Sos. Pipera-Tunari nr. 1/1  
 building 1, 2nd floor | 077190 Voluntari, Ilfov  
 Tel.: +40-(0)31 421 85 68 | Email: info-RO@wago.com

Aveți întrebări despre produsele noastre?

Vă stăm la dispoziție pentru preluarea apelului la +40 (0) 31 421 85 68.



### Ratings per IEC/EN 60664-1

Ratings per	IEC/EN 60664-1
Nominal voltage (III/3)	160 V
Rated surge voltage (III/3)	2,5 kV
Rated voltage (III/2)	160 V
Rated surge voltage (III/2)	2,5 kV
Nominal voltage (II/2)	320 V
Rated surge voltage (II/2)	2,5 kV
Rated current	10 A
Legend (ratings)	(III / 2) $\triangleq$ Overvoltage category III / Pollution degree 2

### Approvals per UL 1059

Rated voltage UL (Use Group B)	300 V
Rated current UL (Use Group B)	10 A
Rated voltage UL (Use Group D)	300 V
Rated current UL (Use Group D)	10 A
Approvals per	UL 1059

### Connection data

Connection technology	Push-in CAGE CLAMP <sup>®</sup>
Actuation type	Push-button
Solid conductor	0,2 ... 1,5 mm <sup>2</sup> / 24 ... 14 AWG
Fine-stranded conductor	0,2 ... 1,5 mm <sup>2</sup> / 24 ... 14 AWG
Fine-stranded conductor; with insulated ferrule	0,25 ... 0,75 mm <sup>2</sup>
Fine-stranded conductor; with uninsulated ferrule	0,25 ... 1,5 mm <sup>2</sup>
Strip length	8 ... 9 mm / 0.31 ... 0.35 inch
Pole No.	8
Total number of connection points	8
Total number of potentials	8
Number of connection types	1
Number of levels	1

### Geometrical Data

Pin spacing	3,5 mm / 0.138 inch
Width	30 mm / 1.181 inch

Supus modificărilor.

WAGO Kontakttechnik GmbH & Co. KG  
 /Representative Office Romania  
 Sos. Pipera-Tunari nr. 1/1  
 building 1, 2nd floor | 077190 Voluntari, Ilfov  
 Tel.: +40-(0)31 421 85 68 | Email: info-RO@wago.com

Aveți întrebări despre produsele noastre?  
 Vă stăm la dispoziție pentru preluarea apelului la +40 (0) 31 421 85 68.



Height	15,9 mm / 0.626 inch
Depth	47 mm / 1.85 inch

**Mechanical data**

Design	With gripping plate
--------	---------------------

**Plug connection**

Contact type (pluggable connector)	Male connector/plug
Connector (connection type)	for conductor
Mismating protection	No
Locking of plug-in connection	Locking latch

**Material Data**

Color	light gray
Material group	I
Insulation material	Polyphthalamide (PPA GF)
Flammability class per UL94	V0
Clamping spring material	Chrome nickel spring steel (CrNi)
Contact material	Electrolytic copper (E <sub>Cu</sub> )
Contact plating	tin-plated
Fire load	0,188 MJ
Weight	8,1 g

**Environmental Requirements**

Limit temperature range	-60 ... +100 °C
-------------------------	-----------------

**Commercial data**

Product Group	26 (picoMAX)
Packaging type	BOX
Country of origin	DE
GTIN	4050821161349
Customs tariff number	85366990990

**Aprobări / certificate****Country specific Approvals**

Nume

Supus modificărilor.

WAGO Kontakttechnik GmbH & Co. KG  
 /Representative Office Romania  
 Sos. Pipera-Tunari nr. 1/1  
 building 1, 2nd floor | 077190 Voluntari, Ilfov  
 Tel.: +40-(0)31 421 85 68 | Email: info-RO@wago.com



Aveți întrebări despre produsele noastre?  
 Vă stăm la dispoziție pentru preluarea apelului la +40 (0) 31 421 85 68.

Emblemă	Aprobare	Text de aprobare suplimentar	certificat
	CSA DEKRA Certification B.V.	C22.2	2362521

#### UL-Approvals

Emblemă	Aprobare	Text de aprobare suplimentar	Nume certificat
	UL Underwriters Laboratories Inc.	UL 1977	20190909-E45171

#### Counterpart

	<b>Nr. articol</b> 2091-1128 1-conductor female plug; 1.5 mm <sup>2</sup> ; Pin spacing 3.5 mm; 8-pole; 1,50 mm <sup>2</sup> ; light gray	<a href="http://www.wago.com/2091-1128">www.wago.com/2091-1128</a>
	<b>Nr. articol</b> 2091-1308 THT female header; 0.4 x 0.9 mm solder pin; straight; Pin spacing 3.5 mm; 8-pole; light gray	<a href="http://www.wago.com/2091-1308">www.wago.com/2091-1308</a>
	<b>Nr. articol</b> 2091-1328 THT female header; 0.4 x 0.9 mm solder pin; angled; Pin spacing 3.5 mm; 8-pole; light gray	<a href="http://www.wago.com/2091-1328">www.wago.com/2091-1328</a>

#### Produse compatibile

##### Coding

	<b>Nr. articol:</b> 2091-1610 Coding key carrier; suitable for 3.5 mm pin spacing; orange	<a href="http://www.wago.com/2091-1610">www.wago.com/2091-1610</a>
--	--	--

#### Descărcări

##### Documentation

##### Additional Information

Technical explanations	Apr 3, 2019	pdf 3,6 MB	Descărcare
------------------------	-------------	---------------	------------

Supus modificărilor.



## CAD/CAE-Data

### CAD data

2D/3D Models 2091-1508/002-000

URL

Descărcare

---

## Installation Notes

## Familie de produse

**picoMAX**

Afișare globală produse din familie.

Supus modificărilor.

---

WAGO Kontakttechnik GmbH & Co. KG  
/Representative Office Romania  
Sos. Pipera-Tunari nr. 1/1  
building 1, 2nd floor | 077190 Voluntari, Ilfov  
Tel.: +40-(0)31 421 85 68 | Email: info-RO@wago.com

Aveți întrebări despre produsele noastre?  
Vă stăm la dispoziție pentru preluarea apelului la +40 (0) 31 421 85 68.