

## Fișă tehnică | Număr articol: 231-839/001-000

THT male header; 1.0 x 1.0 mm solder pin; angled; Pin spacing 7.5 mm; 9-pole; gray

[www.wago.com/231-839/001-000](http://www.wago.com/231-839/001-000)

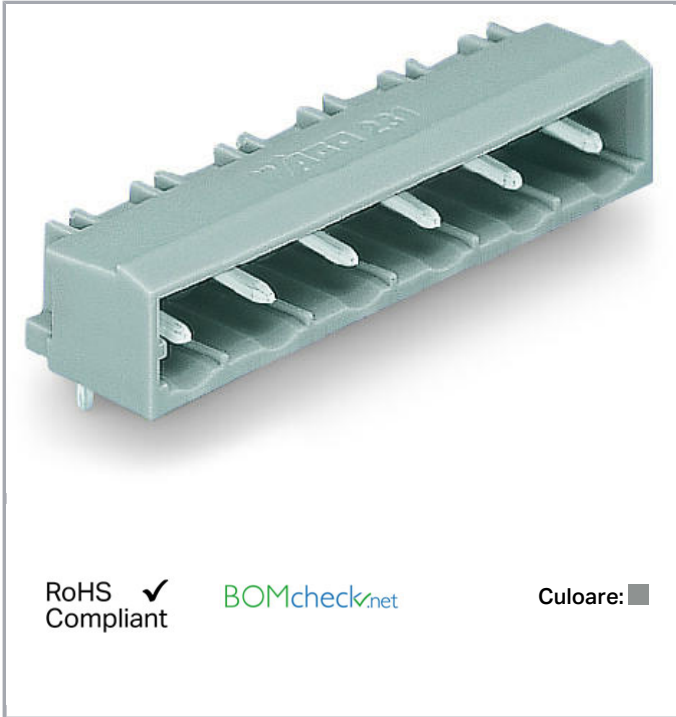

Supus modificărilor.

WAGO Kontakttechnik GmbH & Co. KG  
/Representative Office Romania  
Sos. Pipera-Tunari nr. 1/1  
building 1, 2nd floor | 077190 Voluntari, Ilfov  
Tel.: +40-(0)31 421 85 68 | Email: info-RO@wago.com

Aveți întrebări despre produsele noastre?  
Vă stăm la dispoziție pentru preluarea apelului la +40 (0) 31 421 85 68.

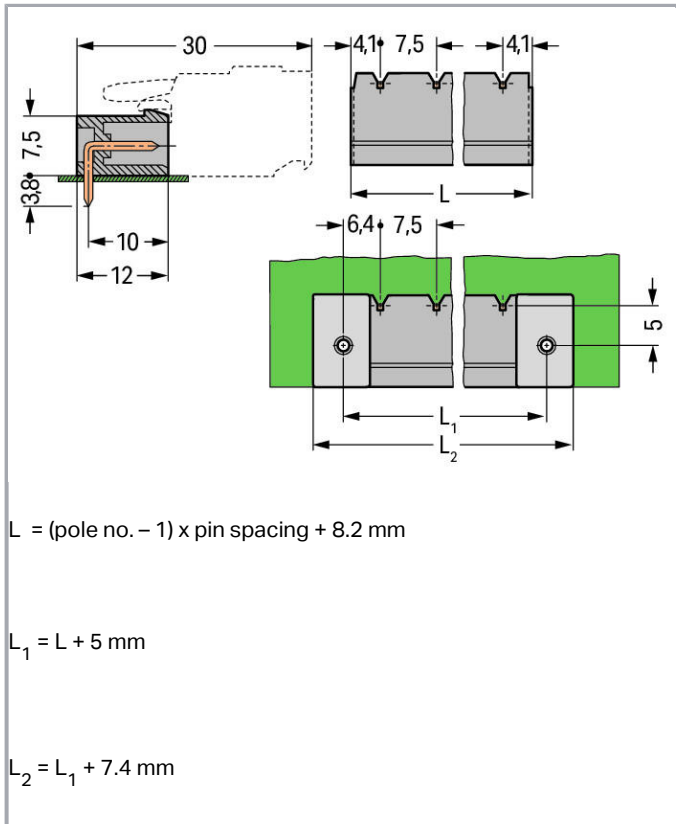

## Descriere articol

- Horizontal or vertical PCB mounting via straight or angled solder pins
- Pin cross-section: 1 x 1 mm
- With coding fingers

### Safety information 1:

The *MULTI CONNECTION SYSTEM (MCS)* is designed without breaking capacity for compliance with DIN EN 61984. When used as intended, MCS Connectors shall not be connected/disconnected when live or under load. The circuit design should ensure header pins, which can be touched, are not live when unmated.

## Date

### Electrical data

### Ratings per IEC/EN 60664-1

Ratings per	IEC/EN 60664-1
Nominal voltage (III/3)	500 V

Supus modificărilor.

WAGO Kontakttechnik GmbH & Co. KG  
 /Representative Office Romania  
 Sos. Pipera-Tunari nr. 1/1  
 building 1, 2nd floor | 077190 Voluntari, Ilfov  
 Tel.: +40-(0)31 421 85 68 | Email: info-RO@wago.com

Aveți întrebări despre produsele noastre?  
 Vă stăm la dispoziție pentru preluarea apelului la +40 (0) 31 421 85 68.



Rated surge voltage (III/3)	6 kV
Rated voltage (III/2)	630 V
Rated surge voltage (III/2)	6 kV
Nominal voltage (II/2)	1000 V
Rated surge voltage (II/2)	6 kV
Rated current	12 A
Legend (ratings)	(III / 2) $\hat{=}$ Overvoltage category III / Pollution degree 2

### Approvals per UL 1059

Rated voltage UL (Use Group B)	300 V
Rated current UL (Use Group B)	10 A
Rated voltage UL (Use Group D)	300 V
Rated current UL (Use Group D)	10 A
Approvals per	UL 1059

### Approvals per UL 1977

Rated voltage UL 1977	600 V
Rated current UL 1977	10 A

### Approvals per CSA

Rated voltage CSA (Use Group B)	300 V
Rated current CSA (Use Group B)	10 A
Rated voltage CSA (Use Group D)	300 V
Rated current CSA (Use Group D)	10 A

### Connection data

Pole No.	9
Total number of potentials	9
Number of connection types	1
Number of levels	1

### Geometrical Data

Pin spacing	7.5 mm / 0.295 inch
Width	68.2 mm / 2.685 inch
Height	12.2 mm / 0.48 inch
Height from the surface	8.4 mm / 0.331 inch

Supus modificărilor.

WAGO Kontakttechnik GmbH & Co. KG  
 /Representative Office Romania  
 Sos. Pipera-Tunari nr. 1/1  
 building 1, 2nd floor | 077190 Voluntari, Ilfov  
 Tel.: +40-(0)31 421 85 68 | Email: info-RO@wago.com

Aveți întrebări despre produsele noastre?  
 Vă stăm la dispoziție pentru preluarea apelului la +40 (0) 31 421 85 68.



Depth	12 mm / 0.472 inch
Solder pin length	3,8 mm
Solder pin dimensions	1 x 1 mm
Drilled hole diameter with tolerance	1.4 <sup>(+0.1)</sup> mm

**Plug connection**

Contact type (pluggable connector)	Male connector/plug
Connector (connection type)	for PCBs
Mismating protection	No
Mating direction to the PCB	0°

**PCB contact**

PCB contact	THT
Solder pin arrangement	over the entire male connector, in line
Number of solder pins per potential	1

**Material Data**

Color	gray
Material group	I
Insulation material	Polyamide 66 (PA 66)
Flammability class per UL94	V0
Contact material	Electrolytic copper (E <sub>Cu</sub> )
Contact plating	tin-plated
Fire load	0,075 MJ
Weight	3,6 g

**Environmental Requirements**

Limit temperature range	-60 ... +100 °C
-------------------------	-----------------

**Commercial data**

Product Group	3 (Multi Conn. System)
Packaging type	BOX
Country of origin	PL
GTIN	4044918868211
Customs tariff number	85366990990



Supus modificărilor.

WAGO Kontakttechnik GmbH & Co. KG  
 /Representative Office Romania  
 Sos. Pipera-Tunari nr. 1/1  
 building 1, 2nd floor | 077190 Voluntari, Ilfov  
 Tel.: +40-(0)31 421 85 68 | Email: info-RO@wago.com

Aveți întrebări despre produsele noastre?  
 Vă stăm la dispoziție pentru preluarea apelului la +40 (0) 31 421 85 68.

## Aprobări / certificate



## Country specific Approvals

Embleă	Aprobare	Text de aprobare suplimentar	Nume certificat
	CSA DEKRA Certification B.V.	C22.2	1466354
	KEMA/KEUR DEKRA Certification B.V.	EN 61984	2190761.01



## Ship Approvals

Embleă	Aprobare	Text de aprobare suplimentar	Nume certificat
	ABS American Bureau of Shipping	-	19- HG1869876- PDA

## UL-Approvals

Embleă	Aprobare	Text de aprobare suplimentar	Nume certificat
	UR Underwriters Laboratories Inc.	UL 1059	E45172
	UR Underwriters Laboratories Inc.	UL 1977	20150318- E45171

## Counterpart

	Nr. articol231-209/026-000 1-conductor female plug; 2.5 mm <sup>2</sup> ; Pin spacing 7.5 mm; 9-pole; 2,50 mm <sup>2</sup> ; gray	<a href="http://www.wago.com/231-209/026-000">www.wago.com/231-209/026-000</a>
	Nr. articol231-2209/026-000 2-conductor female connector; 2.5 mm <sup>2</sup> ; Pin spacing 7.5 mm; 9-pole; 2,50 mm <sup>2</sup> ; gray	<a href="http://www.wago.com/231-2209/026-000">www.wago.com/231-2209/026-000</a>
	Nr. articol231-2209/037-000 2-conductor female connector; Locking lever; 2.5 mm <sup>2</sup> ; Pin spacing 7.5 mm; 9-pole; 2,50 mm <sup>2</sup> ; gray 000	<a href="http://www.wago.com/231-2209/037-000">www.wago.com/231-2209/037-000</a>

Supus modificărilor.

WAGO Kontakttechnik GmbH & Co. KG  
/Representative Office Romania  
Sos. Pipera-Tunari nr. 1/1  
building 1, 2nd floor | 077190 Voluntari, Ilfov  
Tel.: +40-(0)31 421 85 68 | Email: info-RO@wago.com

Aveți întrebări despre produsele noastre?  
Vă stăm la dispoziție pentru preluarea apelului la +40 (0) 31 421 85 68.



	<b>Nr. articol</b> 2231-209/026-000 1-conductor female plug; push-button; 2.5 mm <sup>2</sup> ; Pin spacing 7.5 mm; 9-pole; 2,50 mm <sup>2</sup> ; gray	<a href="http://www.wago.com/2231-209/026-000">www.wago.com/2231-209/026-000</a>
	<b>Nr. articol</b> 2231-209/031-000 1-conductor female plug; push-button; clamping collar; 2.5 mm <sup>2</sup> ; Pin spacing 7.5 mm; 9-pole; 2,50 mm <sup>2</sup> ; gray	<a href="http://www.wago.com/2231-209/031-000">www.wago.com/2231-209/031-000</a>
	<b>Nr. articol</b> 2231-209/037-000 1-conductor female plug; push-button; Locking lever; 2.5 mm <sup>2</sup> ; Pin spacing 7.5 mm; 9-pole; 2,50 mm <sup>2</sup> ; gray	<a href="http://www.wago.com/2231-209/037-000">www.wago.com/2231-209/037-000</a>
	<b>Nr. articol</b> 231-209/027-000 1-conductor female plug; clamping collar; 2.5 mm <sup>2</sup> ; Pin spacing 7.5 mm; 9-pole; 2,50 mm <sup>2</sup> ; gray	<a href="http://www.wago.com/231-209/027-000">www.wago.com/231-209/027-000</a>
	<b>Nr. articol</b> 231-209/031-000 1-conductor female plug; clamping collar; 2.5 mm <sup>2</sup> ; Pin spacing 7.5 mm; 9-pole; 2,50 mm <sup>2</sup> ; gray	<a href="http://www.wago.com/231-209/031-000">www.wago.com/231-209/031-000</a>
	<b>Nr. articol</b> 231-209/037-000 1-conductor female plug; Locking lever; 2.5 mm <sup>2</sup> ; Pin spacing 7.5 mm; 9-pole; 2,50 mm <sup>2</sup> ; gray	<a href="http://www.wago.com/231-209/037-000">www.wago.com/231-209/037-000</a>
	<b>Nr. articol</b> 732-109/026-000 1-conductor female plug; angled; 2.5 mm <sup>2</sup> ; Pin spacing 7.5 mm; 9-pole; 2,50 mm <sup>2</sup> ; gray	<a href="http://www.wago.com/732-109/026-000">www.wago.com/732-109/026-000</a>

## Produse compatibile

### Coding

	<b>Nr. articol:</b> 231-130 Coding key; snap-on type; light gray	<a href="http://www.wago.com/231-130">www.wago.com/231-130</a>
	<b>Nr. articol:</b> 231-500 Spacer; for formation of groups; light gray	<a href="http://www.wago.com/231-500">www.wago.com/231-500</a>

### Marking accessories

	<b>Nr. articol:</b> 210-833 Marking strips; on reel; 6 mm wide; plain; Self-adhesive; white	<a href="http://www.wago.com/210-833">www.wago.com/210-833</a>
	<b>Nr. articol:</b> 210-834 Marking strips; on reel; 5 mm wide; plain; Self-adhesive; white	<a href="http://www.wago.com/210-834">www.wago.com/210-834</a>

## Descărcări

### Documentation

### Additional Information

Supus modificărilor.

WAGO Kontakttechnik GmbH & Co. KG  
/Representative Office Romania  
Sos. Pipera-Tunari nr. 1/1  
building 1, 2nd floor | 077190 Voluntari, Ilfov  
Tel.: +40-(0)31 421 85 68 | Email: info-RO@wago.com

Aveți întrebări despre produsele noastre?  
Vă stăm la dispoziție pentru preluarea apelului la +40 (0) 31 421 85 68.



Technical explanations

Apr 3, 2019

pdf  
3,6 MB

Descărcare

## CAD/CAE-Data

### CAD data

2D/3D Models 231-839/001-000

URL

Descărcare

### CAE data

EPLAN Data Portal 231-839/001-000

URL

Descărcare

### PCB Design

Symbol and Footprint 231-839/001-000

URL

Descărcare

CAX data for your PCB design, consisting of "schematic symbols and PCB footprints", allow easy integration of the WAGO component into your development environment.

### Supported formats:

- Accel EDA 14 & 15
- Altium 6 to current version
- Cadence Allegro
- DesignSpark
- Eagle Libraries
- KiCad
- Mentor Graphics BoardStation
- Mentor Graphics Design Architect
- Mentor Graphics Design Expedition 99 and 2000
- OrCAD 9.X PCB and Capture
- PADS PowerPCB 3, 3.5, 4.X, and 5.X
- PADS PowerPCB and PowerLogic 3.0
- PCAD 2000, 2001, 2002, 2004, and 2006
- Pulsonix 8.5 or newer
- STL
- 3D STEP
- TARGET 3001!
- View Logic ViewDraw
- Quadcept
- Zuken CadStar 3 and 4

—  
Supus modificărilor.

WAGO Kontakttechnik GmbH & Co. KG  
 /Representative Office Romania  
 Sos. Pipera-Tunari nr. 1/1  
 building 1, 2nd floor | 077190 Voluntari, Ilfov  
 Tel.: +40-(0)31 421 85 68 | Email: info-RO@wago.com

Aveți întrebări despre produsele noastre?

Vă stăm la dispoziție pentru preluarea apelului la +40 (0) 31 421 85 68.

- Zuken CR-5000 and CR-8000

PCB Component Libraries (EDA), PCB CAD Library Ultra Librarian

---

## Installation Notes

### Coding

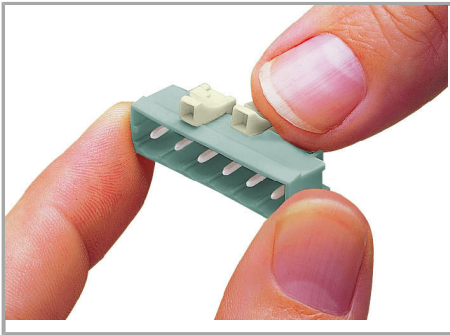

Coding a male header – fitting coding key(s).

## Familie de produse

*MCS* MIDI Classic

Afișare globală produse din familie.

Supus modificărilor.

---

WAGO Kontakttechnik GmbH & Co. KG  
/Representative Office Romania  
Sos. Pipera-Tunari nr. 1/1  
building 1, 2nd floor | 077190 Voluntari, Ilfov  
Tel.: +40-(0)31 421 85 68 | Email: [info-RO@wago.com](mailto:info-RO@wago.com)

Aveți întrebări despre produsele noastre?

Vă stăm la dispoziție pentru preluarea apelului la +40 (0) 31 421 85 68.