

Fișă tehnică | Număr articol: 2092-1128/000-1000

1-conductor female plug; direct marking; 2.5 mm²; Pin spacing 5 mm; 8-pole;
2,50 mm²; light gray

www.wago.com/2092-1128/000-1000



Supus modificărilor.

WAGO Kontakttechnik GmbH & Co. KG
/Representative Office Romania
Sos. Pipera-Tunari nr. 1/1
building 1, 2nd floor | 077190 Voluntari, Ilfov
Tel.: +40-(0)31 421 85 68 | Email: info-RO@wago.com

Aveți întrebări despre produsele noastre?
Vă stăm la dispoziție pentru preluarea apelului la +40 (0) 31 421 85 68.

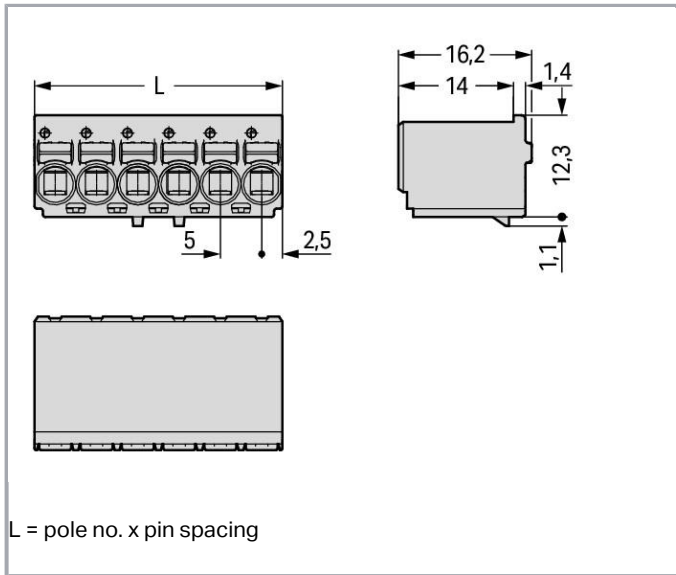

Descriere articol

- Universal connection of all conductor types
- Simple, push-in termination of solid and ferruled conductors
- Easy-to-use design does not require special tools
- Ability to wire while mated or unmated
- Testing parallel to conductor entry – tip contact
- Also available with gripping plates
- Integrated locking latches prevent accidental disconnection

Safety information 1:

The **picoMAX[®] pluggable connection system** is designed without breaking capacity for compliance with DIN EN 61984. When used as intended, MCS Connectors shall not be connected/disconnected when live or under load. The circuit design should ensure header pins, which can be touched, are not live when unmated.

Date

Electrical data

Ratings per IEC/EN 60664-1

| Ratings per | IEC/EN 60664-1 |
|-----------------------------|----------------|
| Nominal voltage (III/3) | 250 V |
| Rated surge voltage (III/3) | 4 kV |
| Rated voltage (III/2) | 320 V |

Supus modificărilor.

WAGO Kontakttechnik GmbH & Co. KG
 /Representative Office Romania
 Sos. Pipera-Tunari nr. 1/1
 building 1, 2nd floor | 077190 Voluntari, Ilfov
 Tel.: +40-(0)31 421 85 68 | Email: info-RO@wago.com

Aveți întrebări despre produsele noastre?
 Vă stăm la dispoziție pentru preluarea apelului la +40 (0) 31 421 85 68.



| | |
|-----------------------------|--|
| Rated surge voltage (III/2) | 4 kV |
| Nominal voltage (II/2) | 630 V |
| Rated surge voltage (II/2) | 4 kV |
| Rated current | 16 A |
| Legend (ratings) | (III / 2) \triangleq Overvoltage category III / Pollution degree 2 |

Approvals per UL 1059

| | |
|--------------------------------|---------|
| Rated voltage UL (Use Group B) | 300 V |
| Rated current UL (Use Group B) | 15 A |
| Rated voltage UL (Use Group D) | 300 V |
| Rated current UL (Use Group D) | 10 A |
| Approvals per | UL 1059 |

Connection data

| | |
|---|---|
| Connection technology | Push-in CAGE CLAMP® |
| Actuation type | Push-button |
| Solid conductor | 0.2 ... 2.5 mm ² / 24 ... 12 AWG |
| Fine-stranded conductor | 0.2 ... 2.5 mm ² / 24 ... 12 AWG |
| Fine-stranded conductor; with insulated ferrule | 0.25 ... 1.5 mm ² |
| Fine-stranded conductor; with uninsulated ferrule | 0.25 ... 2.5 mm ² |
| Strip length | 9 ... 10 mm / 0.35 ... 0.39 inch |
| Pole No. | 8 |
| Total number of connection points | 8 |
| Total number of potentials | 8 |
| Number of connection types | 1 |
| Number of levels | 1 |

Geometrical Data

| | |
|-------------|----------------------|
| Pin spacing | 5 mm / 0.197 inch |
| Width | 40 mm / 1.575 inch |
| Height | 16.2 mm / 0.638 inch |
| Depth | 13.4 mm / 0.528 inch |

Plug connection

| | |
|------------------------------------|-------------------------|
| Contact type (pluggable connector) | Female connector/socket |
| Connector (connection type) | for conductors |

Supus modificărilor.

WAGO Kontakttechnik GmbH & Co. KG
 /Representative Office Romania
 Sos. Pipera-Tunari nr. 1/1
 building 1, 2nd floor | 077190 Voluntari, Ilfov
 Tel.: +40-(0)31 421 85 68 | Email: info-RO@wago.com

Aveți întrebări despre produsele noastre?
 Vă stăm la dispoziție pentru preluarea apelului la +40 (0) 31 421 85 68.

| | |
|----------------------|----|
| Mismating protection | No |
|----------------------|----|

Material Data

| | |
|-----------------------------|--|
| Color | light gray |
| Material group | I |
| Insulation material | Polyphthalamide (PPA GF) |
| Flammability class per UL94 | V0 |
| Clamping spring material | Chrome nickel spring steel (CrNi) |
| Contact material | Electrolytic copper (E _{Cu}) |
| Contact plating | tin-plated |
| Fire load | 0,171 MJ |
| Weight | 7,3 g |

Environmental Requirements

| | |
|-------------------------|-----------------|
| Limit temperature range | -60 ... +100 °C |
|-------------------------|-----------------|

Commercial data

| | |
|-----------------------|---------------|
| Packaging type | BOX |
| Country of origin | DE |
| GTIN | 4050821357827 |
| Customs tariff number | 85366990990 |

Aprobări / certificate

Country specific Approvals

| Emblemă | Aprobare | Text de aprobare suplimentar | Nume certificat |
|--|---------------------------------|------------------------------|-----------------|
|  | CSA DEKRA Certification B.V. | C22.2 | 2362521 |

UL-Approvals

| Emblemă | Aprobare | Text de aprobare suplimentar | Nume certificat |
|--|--------------------------------------|------------------------------|---------------------|
|  | UL Underwriters Laboratories Inc. | UL 1977 | 20190909- E45171 |

Supus modificărilor.

WAGO Kontakttechnik GmbH & Co. KG
/Representative Office Romania
Sos. Pipera-Tunari nr. 1/1
building 1, 2nd floor | 077190 Voluntari, Ilfov
Tel.: +40-(0)31 421 85 68 | Email: info-RO@wago.com

Aveți întrebări despre produsele noastre?
Vă stăm la dispoziție pentru preluarea apelului la +40 (0) 31 421 85 68.

Counterpart



Nr. articol: 2092-1428

THT male header; 1.4 mm Ø solder pin; angled; Pin spacing 5 mm; 8-pole; light gray

www.wago.com/2092-1428



Nr. articol: 2092-1408

THT male header; 1.4 mm Ø solder pin; straight; Pin spacing 5 mm; 8-pole; light gray

www.wago.com/2092-1408

Produse compatibile

check



Nr. articol: 735-500

Test pin; 1 mm Ø; with solder connection for test wire

www.wago.com/735-500

tools



Nr. articol: 2092-1630

Unlocking tool; orange

www.wago.com/2092-1630



Nr. articol: 210-719

Operating tool; Blade: 2.5 x 0.4 mm; with a partially insulated shaft

www.wago.com/210-719

Strain relief plate



Nr. articol: 2092-1602/002-000

Gripping plate with sliding connector release; light gray

www.wago.com/2092-1602/002-000

Descărcări

Documentation

Additional Information

Technical explanations

Apr 3, 2019

pdf
3,6 MB

Descărcare

Installation Notes

Locking lever

Supus modificărilor.

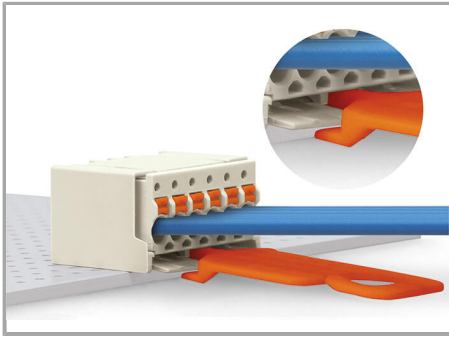

Disconnecting female connector via unlocking tool. Plug unlocking tool into the male header's locking latch.

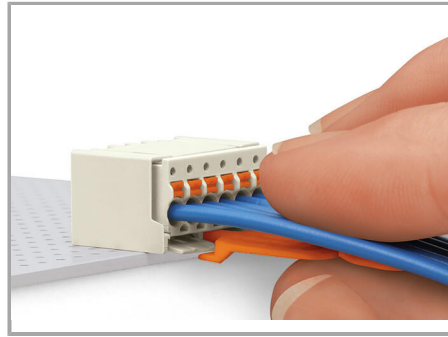

Insert unlocking tool until it hits backstop. Wedge opens locking latch.

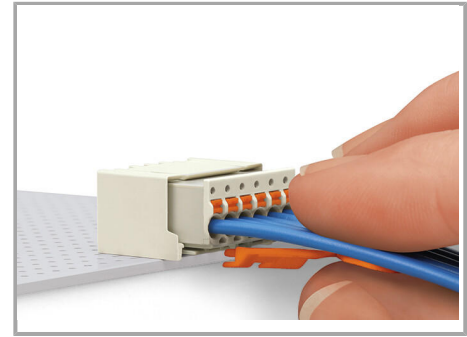

Pull on both unlocking tool and conductors to remove female connector from male header.

Conductor termination

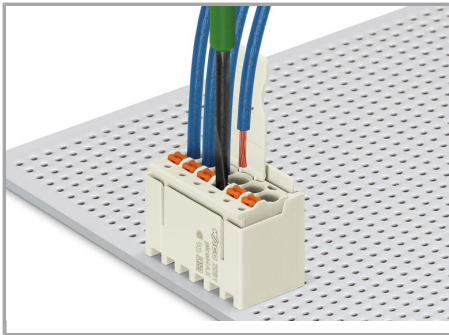

Inserting fine-stranded conductor into mated female connector via push-button.

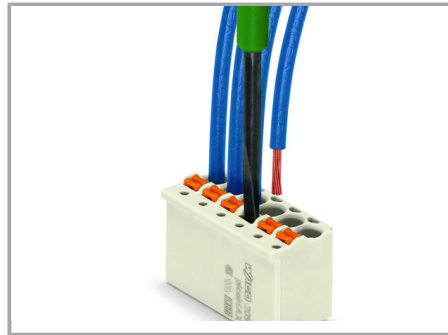

Inserting fine-stranded conductor into unmated female connector via push-button.

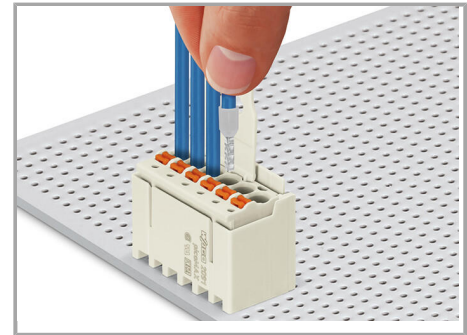

Inserting solid and ferruled conductors via push-in termination

Marking



Pole marking via factory direct printing.

Coding

Supus modificărilor.

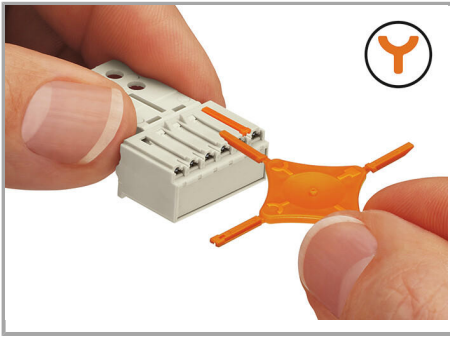

Coding a female connector (via coding key carrier and two keys for female connector, see symbol).

Testing

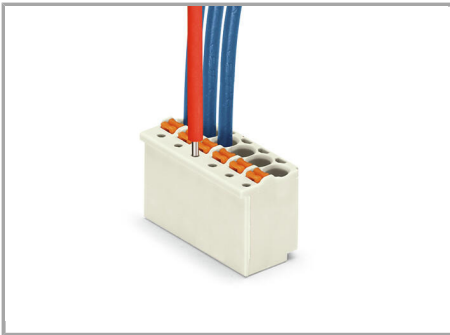

Testing with 1 mm Ø test pin, tip contact.

Familie de produse

picoMAX

Afișare globală produse din familie.

Supus modificărilor.