

Fișă tehnică | Număr articol: 2092-1106/000-5000

1-conductor female plug; Gripping plate; direct marking; 2.5 mm<sup>2</sup>; Pin spacing 5 mm; 6-pole; 2,50 mm<sup>2</sup>; light gray

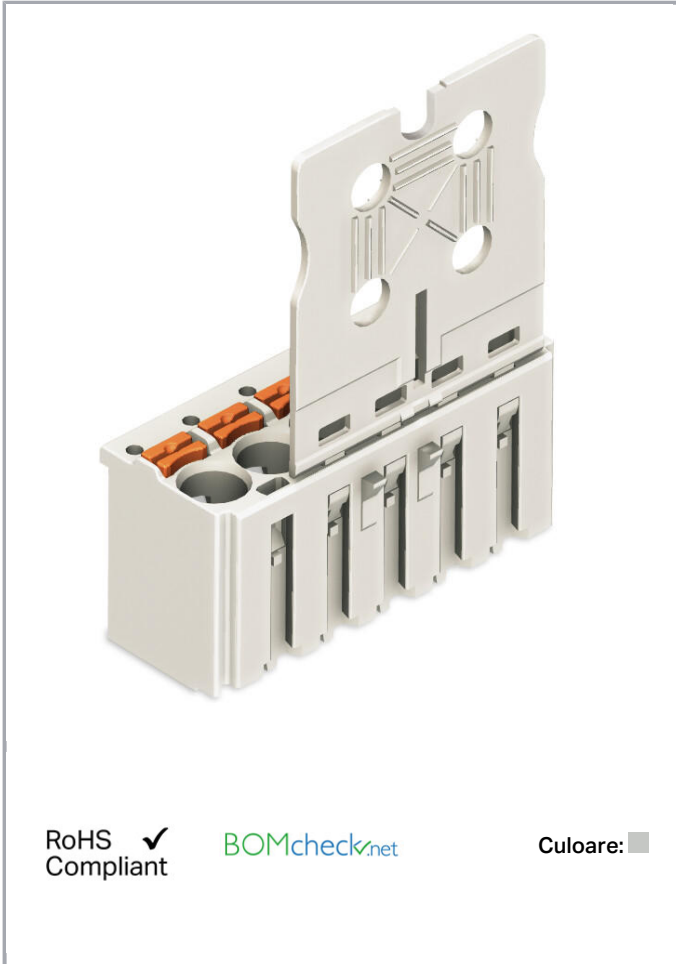

[www.wago.com/2092-1106/000-5000](http://www.wago.com/2092-1106/000-5000)



Supus modificărilor.

WAGO Kontakttechnik GmbH & Co. KG  
/Representative Office Romania  
Sos. Pipera-Tunari nr. 1/1  
building 1, 2nd floor | 077190 Voluntari, Ilfov  
Tel.: +40-(0)31 421 85 68 | Email: info-RO@wago.com

Aveți întrebări despre produsele noastre?  
Vă stăm la dispoziție pentru preluarea apelului la +40 (0) 31 421 85 68.

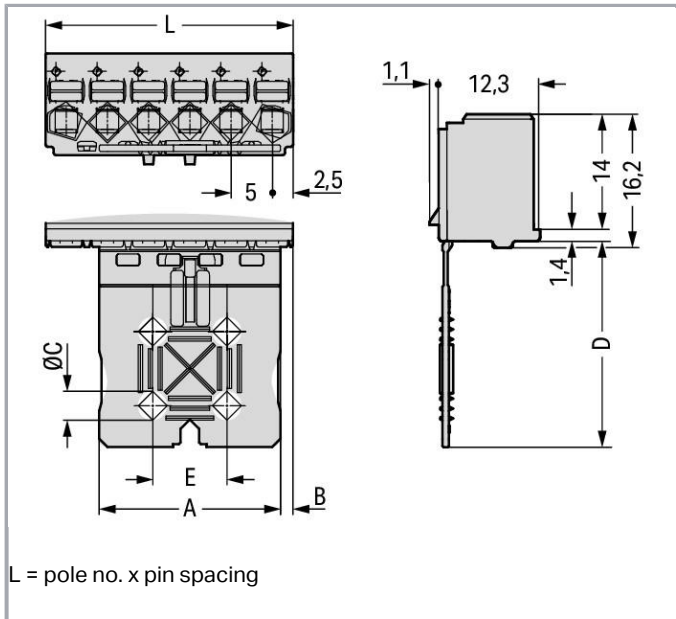

## Descriere articol

- Universal connection for all conductor types
- Simple, push-in termination of solid and ferruled conductors
- Easy-to-use design does not require specialty tools
- Ability to wire while mated or unmated
- Test port parallel to conductor entry – touch contact
- Integrated locking latches prevent accidental disconnection

### Safety information 1:

The **picoMAX® pluggable connection system** is designed without breaking capacity for compliance with DIN EN 61984. When used as intended, MCS Connectors shall not be connected/disconnected when live or under load. The circuit design should ensure header pins, which can be touched, are not live when unmated.

## Date

### Electrical data

### Ratings per IEC/EN 60664-1

Ratings per	IEC/EN 60664-1
Nominal voltage (III/3)	250 V
Rated surge voltage (III/3)	4 kV
Rated voltage (III/2)	320 V

Supus modificărilor.

WAGO Kontakttechnik GmbH & Co. KG  
 /Representative Office Romania  
 Sos. Pipera-Tunari nr. 1/1  
 building 1, 2nd floor | 077190 Voluntari, Ilfov  
 Tel.: +40-(0)31 421 85 68 | Email: info-RO@wago.com

Aveți întrebări despre produsele noastre?  
 Vă stăm la dispoziție pentru preluarea apelului la +40 (0) 31 421 85 68.



Rated surge voltage (III/2)	4 kV
Nominal voltage (II/2)	630 V
Rated surge voltage (II/2)	4 kV
Rated current	16 A
Legend (ratings)	(III / 2) ≙ Overvoltage category III / Pollution degree 2

### Approvals per UL 1059

Rated voltage UL (Use Group B)	300 V
Rated current UL (Use Group B)	15 A
Rated voltage UL (Use Group D)	300 V
Rated current UL (Use Group D)	10 A
Approvals per	UL 1059

### Connection data

Connection technology	Push-in CAGE CLAMP®
Actuation type	Push-button
Solid conductor	0.2 ... 2.5 mm <sup>2</sup> / 24 ... 12 AWG
Fine-stranded conductor	0.2 ... 2.5 mm <sup>2</sup> / 24 ... 12 AWG
Fine-stranded conductor; with insulated ferrule	0.25 ... 1.5 mm <sup>2</sup>
Fine-stranded conductor; with uninsulated ferrule	0.25 ... 2.5 mm <sup>2</sup>
Strip length	9 ... 10 mm / 0.35 ... 0.39 inch
Pole No.	6
Total number of connection points	6
Total number of potentials	6
Number of connection types	1
Number of levels	1

### Geometrical Data

Pin spacing	5 mm / 0.197 inch
Width	30 mm / 1.181 inch
Height	40.4 mm / 1.591 inch
Depth	13.4 mm / 0.528 inch

### Mechanical data

Design	With gripping plate
--------	---------------------

Supus modificărilor.

## Plug connection

Contact type (pluggable connector)	Female connector/socket
Connector (connection type)	for conductors
Mismating protection	No

## Material Data

Color	light gray
Material group	I
Insulation material	Polyphthalamide (PPA GF)
Flammability class per UL94	V0
Clamping spring material	Chrome nickel spring steel (CrNi)
Contact material	Electrolytic copper (E <sub>Cu</sub> )
Contact plating	tin-plated
Fire load	0,144 MJ
Weight	5,7 g

## Environmental Requirements



Limit temperature range	-60 ... +100 °C
-------------------------	-----------------

## Commercial data

Packaging type	BOX
Country of origin	DE
GTIN	4050821353836
Customs tariff number	85366990990

## Aprobări / certificate

### Country specific Approvals

Emblemă	Aprobare	Text de aprobare suplimentar	Nume certificat
	CSA DEKRA Certification B.V.	C22.2	2362521
	KEMA/KEUR DEKRA Certification B.V.	EN 61984	71- 102261 REV.1

Supus modificărilor.



WAGO Kontakttechnik GmbH & Co. KG  
/Representative Office Romania  
Sos. Pipera-Tunari nr. 1/1  
building 1, 2nd floor | 077190 Voluntari, Ilfov  
Tel.: +40-(0)31 421 85 68 | Email: info-RO@wago.com

Aveți întrebări despre produsele noastre?  
Vă stăm la dispoziție pentru preluarea apelului la +40 (0) 31 421 85 68.

## UL-Approvals

Emblemă	Aprobare	Text de aprobare suplimentar	Nume certificat
	UL Underwriters Laboratories Inc.	UL 1977	20190909- E45171

## Counterpart

	Nr. articol 2092-1426 THT male header; 1.4 mm Ø solder pin; angled; Pin spacing 5 mm; 6-pole; light gray	<a href="http://www.wago.com/2092-1426">www.wago.com/2092-1426</a>
	Nr. articol 2092-1406 THT male header; 1.4 mm Ø solder pin; straight; Pin spacing 5 mm; 6-pole; light gray	<a href="http://www.wago.com/2092-1406">www.wago.com/2092-1406</a>
	Nr. articol 2092-1526/002-000 1-conductor male connector; Gripping plate; 2.5 mm <sup>2</sup> ; Pin spacing 5 mm; 6-pole; 2,50 mm <sup>2</sup> ; light gray	<a href="http://www.wago.com/2092-1526/002-000">www.wago.com/2092-1526/002-000</a>

## Produse compatibile

## check

	Nr. articol: 735-500 Test pin; 1 mm Ø; with solder connection for test wire	<a href="http://www.wago.com/735-500">www.wago.com/735-500</a>
--	--	--

## tools

	Nr. articol: 210-719 Operating tool; Blade: 2.5 x 0.4 mm; with a partially insulated shaft	<a href="http://www.wago.com/210-719">www.wago.com/210-719</a>
--	---	--

## Descărcări

## Documentation

## Additional Information

Technical explanations	Apr 3, 2019	pdf 3,6 MB	Descărcare
------------------------	-------------	---------------	------------

## Installation Notes

Supus modificărilor.

WAGO Kontakttechnik GmbH & Co. KG  
/Representative Office Romania  
Sos. Pipera-Tunari nr. 1/1  
building 1, 2nd floor | 077190 Voluntari, Ilfov  
Tel.: +40-(0)31 421 85 68 | Email: info-RO@wago.com

Aveți întrebări despre produsele noastre?  
Vă stăm la dispoziție pentru preluarea apelului la +40 (0) 31 421 85 68.

### Locking

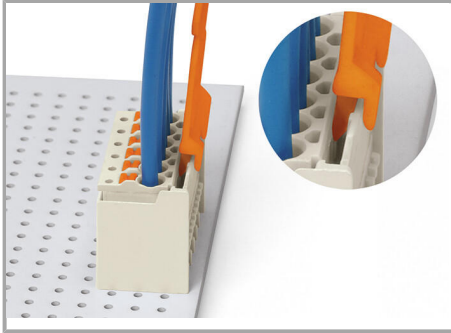

Disconnecting female connector via unlocking tool. Plug unlocking tool into the male locking latch.

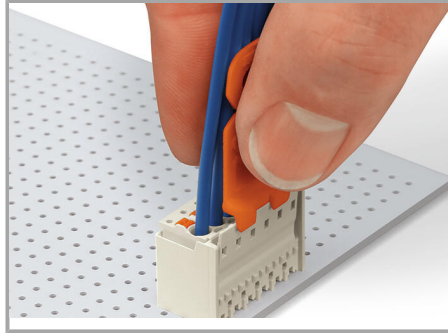

Insert unlocking tool until it hits backstop. Wedge opens locking latch.

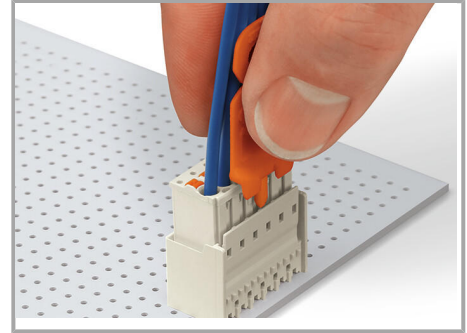

Pull on both unlocking tool and conductors to remove female connector from male header.

### Conductor termination

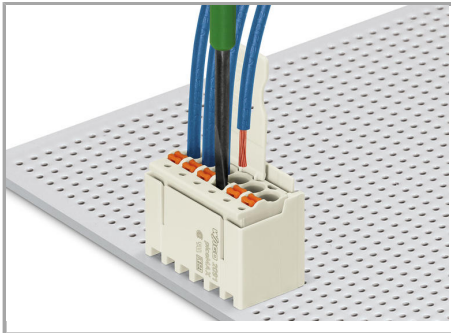

Inserting fine-stranded conductor into mated female connector via push-button.

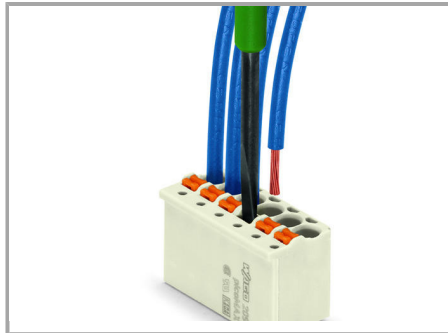

Inserting fine-stranded conductor into unmated female connector via push-button.

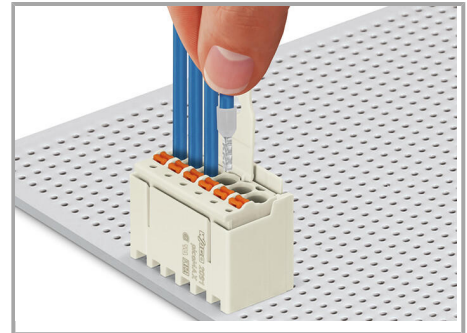

Inserting solid and ferruled conductors via push-in termination

### Marking



Pole marking via factory direct printing.

### Coding

Supus modificărilor.

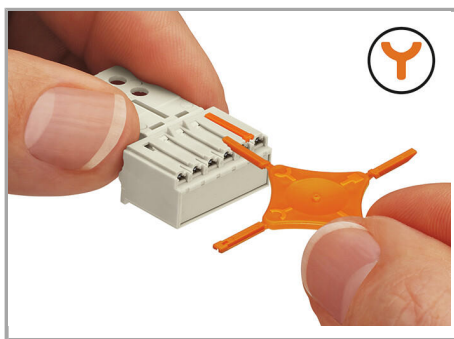

Coding a female connector (via coding key carrier and two keys for female connector, see symbol).

#### Testing

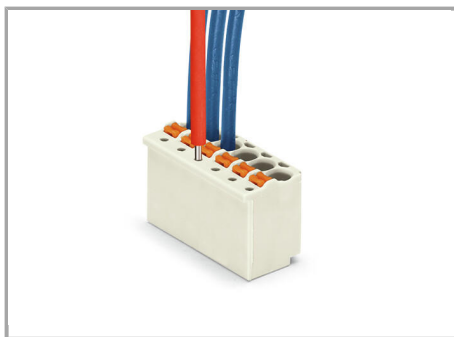

Testing with 1 mm Ø test pin, tip contact.

#### Familie de produse

**picoMAX**

Afișare globală produse din familie.

Supus modificărilor.