

# Fișă tehnică | Număr articol: 2091-1725/200-000

Solder pin strip; 1.0 mm Ø solder pin; angled; Pin spacing 3.5 mm; 5-pole; black

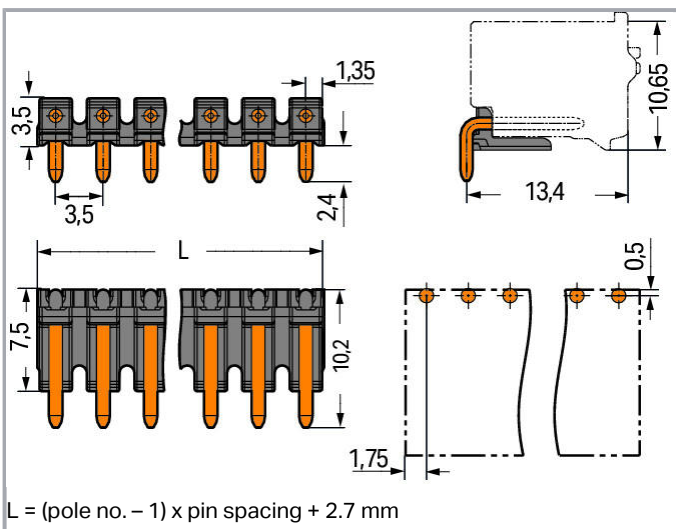

[www.wago.com/2091-1725/200-000](http://www.wago.com/2091-1725/200-000)

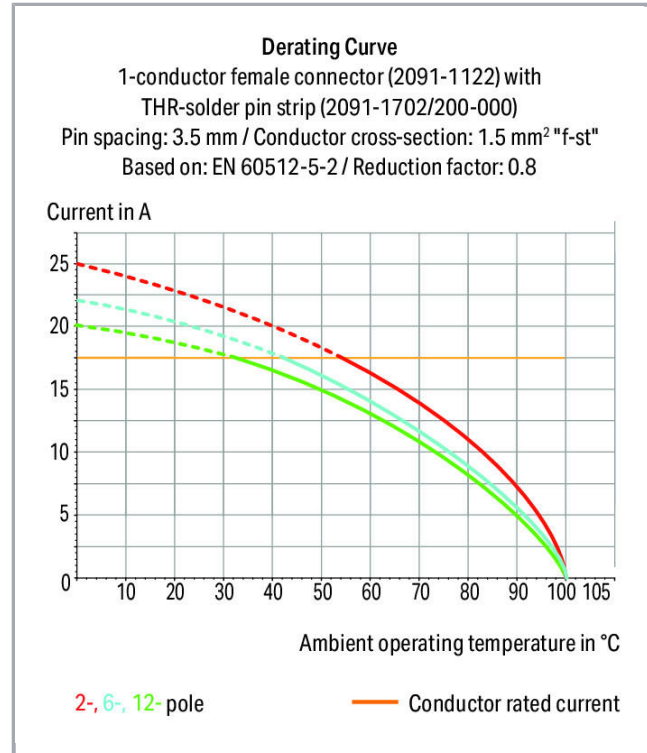
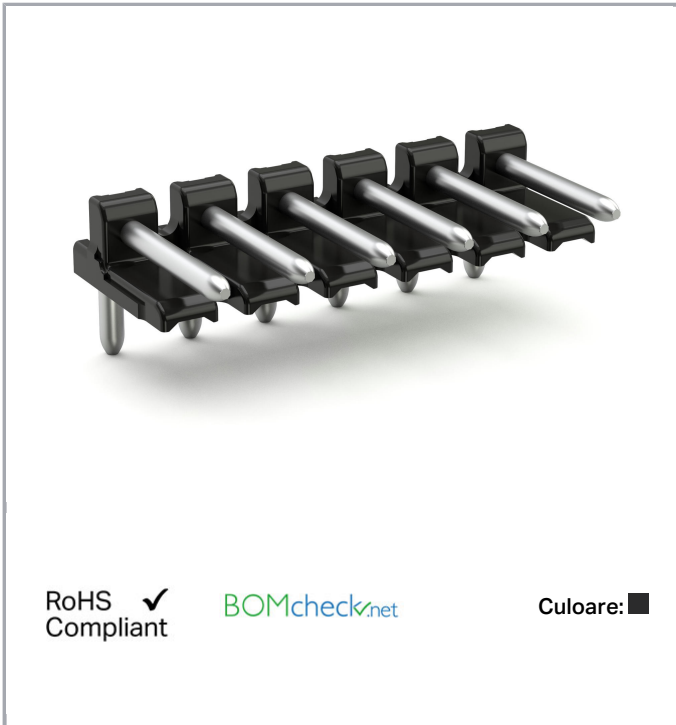

## Descriere articol

Supus modificărilor.

WAGO Kontakttechnik GmbH & Co. KG  
/Representative Office Romania  
Sos. Pipera-Tunari nr. 1/1  
building 1, 2nd floor | 077190 Voluntari, Ilfov  
Tel.: +40-(0)31 421 85 68 | Email: info-RO@wago.com

Aveți întrebări despre produsele noastre?  
Vă stăm la dispoziție pentru preluarea apelului la +40 (0) 31 421 85 68.



- Lötstiftleisten mit geraden und abgewinkelten Lötstiften für rechtwinklige und parallele Steckrichtung zur Leiterplatte
- Polverlustfreies Aneinanderreihen von mehreren Federleisten in einer Lötstiftleiste zur Trennung von Funktionen möglich

**Safety information 1:**

The **picoMAX<sup>®</sup> pluggable connection system** is designed without breaking capacity for compliance with DIN EN 61984. When used as intended, MCS Connectors shall not be connected/disconnected when live or under load. The circuit design should ensure header pins, which can be touched, are not live when unmated.

**Date****Electrical data****Ratings per IEC/EN 60664-1**

Ratings per	IEC/EN 60664-1
Nominal voltage (III/3)	160 V
Rated surge voltage (III/3)	2,5 kV
Rated voltage (III/2)	160 V
Rated surge voltage (III/2)	2,5 kV
Nominal voltage (II/2)	320 V
Rated surge voltage (II/2)	2,5 kV
Rated current	10 A
Legend (ratings)	(III / 2) ≙ Overvoltage category III / Pollution degree 2

**Approvals per UL 1059**

Approvals per	UL 1059
---------------	---------

**Connection data**

Pole No.	5
Number of connection types	1
Number of levels	1

**Geometrical Data**

Pin spacing	3.5 mm / 0.138 inch
Width	19.2 mm / 0.756 inch
Height	5.9 mm / 0.232 inch
Height from the surface	3.5 mm / 0.138 inch
Depth	10.2 mm / 0.402 inch
Solder pin length	2,4 mm

Supus modificărilor.

WAGO Kontakttechnik GmbH & Co. KG  
 /Representative Office Romania  
 Sos. Pipera-Tunari nr. 1/1  
 building 1, 2nd floor | 077190 Voluntari, Ilfov  
 Tel.: +40-(0)31 421 85 68 | Email: info-RO@wago.com

Aveți întrebări despre produsele noastre?  
 Vă stăm la dispoziție pentru preluarea apelului la +40 (0) 31 421 85 68.



Solder pin diameter	1 mm
Plated through-hole diameter (THR)	1.2 <sup>(+0.1)</sup> mm

**Plug connection**

Contact type (pluggable connector)	Male connector/plug
Connector (connection type)	for PCBs
Mismatching protection	No
Mating direction to the PCB	0°

**PCB contact**

PCB contact	THR
-------------	-----

**Material Data**

Color	black
Material group	I
Insulation material	Polyphthalamide (PPA GF)
Flammability class per UL94	V0
Contact material	Electrolytic copper (E <sub>Cu</sub> )
Contact plating	tin-plated
Weight	0,6 g

**Environmental Requirements**

Limit temperature range	-60 ... +100 °C
-------------------------	-----------------

**Commercial data**

Packaging type	bag
Country of origin	CN
GTIN	4055143935654
Customs tariff number	85369010000

**Aprobări / certificate****Country specific Approvals**

Emblemă	Aprobare	Text de aprobare suplimentar	Nume certificat
	<b>CSA</b> DEKRA Certification B.V.	C22.2	2362521

Supus modificărilor.

WAGO Kontakttechnik GmbH & Co. KG  
 /Representative Office Romania  
 Sos. Pipera-Tunari nr. 1/1  
 building 1, 2nd floor | 077190 Voluntari, Ilfov  
 Tel.: +40-(0)31 421 85 68 | Email: info-RO@wago.com

Aveți întrebări despre produsele noastre?  
 Vă stăm la dispoziție pentru preluarea apelului la +40 (0) 31 421 85 68.



#### UL-Approvals

Emblemă	Aprobare	Text de aprobare suplimentar	Nume certificat
	UL Underwriters Laboratories Inc.	UL 1977	20190909- E45171

#### Counterpart



Nr. articol 2091-1125

1-conductor female plug; 1.5 mm<sup>2</sup>; Pin spacing 3.5 mm; 5-pole; 1,50 mm<sup>2</sup>; light gray

[www.wago.com/2091-1125](http://www.wago.com/2091-1125)

#### Descărcări

##### Documentation

##### Additional Information

Technical explanations	Apr 3, 2019	pdf 3,6 MB	Descărcare
------------------------	-------------	---------------	------------

#### Installation Notes

#### Familie de produse

**picoMAX**

Afișare globală produse din familie.

Supus modificărilor.