

Fișă tehnică | Număr articol: 2091-1105/000-1000

1-conductor female plug; Gripping plate; direct marking; 1.5 mm²; Pin spacing 3.5 mm; 5-pole; 1,50 mm²; light gray

www.wago.com/2091-1105/000-1000



RoHS Compliant

[BOMcheck.net](https://www.bomcheck.net)

Culoare:

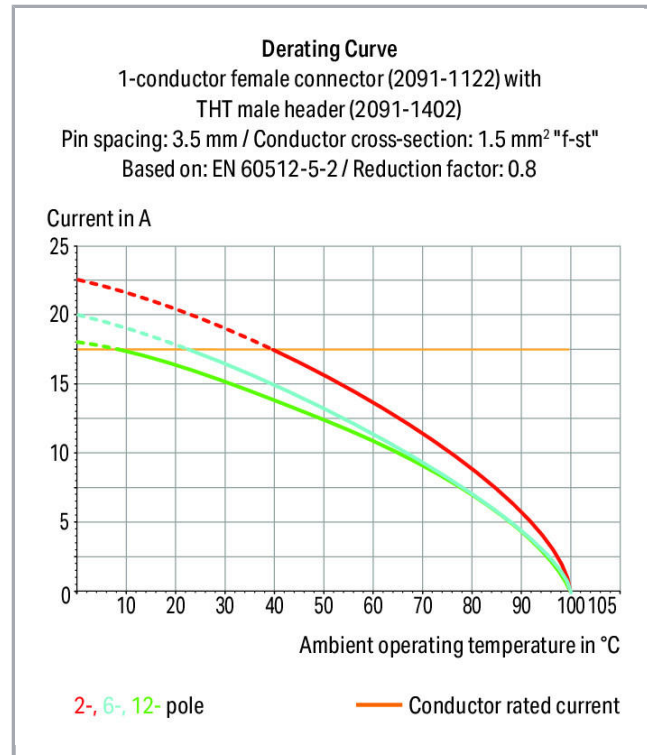

Supus modificărilor.

WAGO Kontakttechnik GmbH & Co. KG
/Representative Office Romania
Sos. Pipera-Tunari nr. 1/1
building 1, 2nd floor | 077190 Voluntari, Ilfov
Tel.: +40-(0)31 421 85 68 | Email: info-RO@wago.com

Aveți întrebări despre produsele noastre?
Vă stăm la dispoziție pentru preluarea apelului la +40 (0) 31 421 85 68.

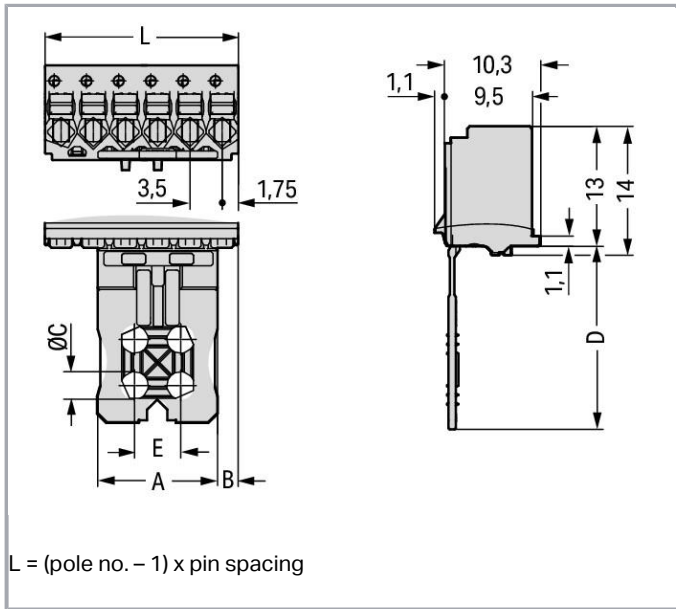

Descriere articol

- Universal connection for all conductor types
- Simple, push-in termination of solid and ferruled conductors
- Easy-to-use design does not require specialty tools
- Ability to wire while mated or unmated
- Test port parallel to conductor entry – touch contact
- Integrated locking latches prevent accidental disconnection

Safety information 1:

The picoMAX® pluggable connection system is designed without breaking capacity for compliance with DIN EN 61984. When used as intended, MCS Connectors shall not be connected/disconnected when live or under load. The circuit design should ensure header pins, which can be touched, are not live when unmated.

Date

Electrical data

Ratings per IEC/EN 60664-1

Ratings per	IEC/EN 60664-1
Nominal voltage (III/3)	160 V
Rated surge voltage (III/3)	2,5 kV
Rated voltage (III/2)	160 V

Supus modificărilor.

WAGO Kontakttechnik GmbH & Co. KG
 /Representative Office Romania
 Sos. Pipera-Tunari nr. 1/1
 building 1, 2nd floor | 077190 Voluntari, Ilfov
 Tel.: +40-(0)31 421 85 68 | Email: info-RO@wago.com

Aveți întrebări despre produsele noastre?
 Vă stăm la dispoziție pentru preluarea apelului la +40 (0) 31 421 85 68.



Rated surge voltage (III/2)	2,5 kV
Nominal voltage (II/2)	320 V
Rated surge voltage (II/2)	2,5 kV
Rated current	10 A
Legend (ratings)	(III / 2) \triangleq Overvoltage category III / Pollution degree 2

Approvals per UL 1059

Rated voltage UL (Use Group B)	300 V
Rated current UL (Use Group B)	10 A
Rated voltage UL (Use Group D)	300 V
Rated current UL (Use Group D)	10 A
Approvals per	UL 1059

Connection data

Connection technology	Push-in CAGE CLAMP [®]
Actuation type	Push-button
Solid conductor	0.2 ... 1.5 mm ² / 24 ... 14 AWG
Fine-stranded conductor	0.2 ... 1.5 mm ² / 24 ... 14 AWG
Fine-stranded conductor; with insulated ferrule	0.25 ... 0.75 mm ²
Fine-stranded conductor; with uninsulated ferrule	0.25 ... 1.5 mm ²
Strip length	8 ... 9 mm / 0.31 ... 0.35 inch
Pole No.	5
Total number of connection points	5
Total number of potentials	5
Number of connection types	1
Number of levels	1

Geometrical Data

Pin spacing	3.5 mm / 0.138 inch
Width	17.5 mm / 0.689 inch
Height	33 mm / 1.299 inch
Depth	11.4 mm / 0.449 inch

Mechanical data

Design	With gripping plate
--------	---------------------

Supus modificărilor.

Plug connection

Contact type (pluggable connector)	Female connector/socket
Connector (connection type)	for conductors
Mismating protection	No

Material Data

Color	light gray
Material group	I
Insulation material	Polyphthalamide (PPA GF)
Flammability class per UL94	V0
Clamping spring material	Chrome nickel spring steel (CrNi)
Contact material	Electrolytic copper (E _{Cu})
Contact plating	tin-plated
Fire load	0,059 MJ
Weight	2,4 g

Environmental Requirements



Limit temperature range	-60 ... +100 °C
-------------------------	-----------------

Commercial data

Packaging type	BOX
Country of origin	DE
GTIN	4050821365860
Customs tariff number	85366990990

Aprobări / certificate

Country specific Approvals

Emblemă	Aprobare	Text de aprobare suplimentar	Nume certificat
	CSA DEKRA Certification B.V.	C22.2	2362521
	KEMA/KEUR DEKRA Certification B.V.	EN 61984	71- 102260 REV.1

Supus modificărilor.



WAGO Kontakttechnik GmbH & Co. KG
/Representative Office Romania
Sos. Pipera-Tunari nr. 1/1
building 1, 2nd floor | 077190 Voluntari, Ilfov
Tel.: +40-(0)31 421 85 68 | Email: info-RO@wago.com

Aveți întrebări despre produsele noastre?
Vă stăm la dispoziție pentru preluarea apelului la +40 (0) 31 421 85 68.

UL-Approvals

Emblemă	Aprobare	Text de aprobare suplimentar	Nume certificat
	UL Underwriters Laboratories Inc.	UL 1977	20190909- E45171

Counterpart

	Nr. articol 2091-1425 THT male header; 1.0 mm Ø solder pin; angled; Pin spacing 3.5 mm; 5-pole; light gray	www.wago.com/2091-1425
	Nr. articol 2091-1405 THT male header; 1.0 mm Ø solder pin; straight; Pin spacing 3.5 mm; 5-pole; light gray	www.wago.com/2091-1405
	Nr. articol 2091-1525/002-000 1-conductor male connector; Integrated release lever; 1.5 mm ² ; Pin spacing 3.5 mm; 5-pole; 1,50 mm ² ; light gray	www.wago.com/2091-1525/002-000

Produse compatibile

check

	Nr. articol: 735-500 Test pin; 1 mm Ø; with solder connection for test wire	www.wago.com/735-500
--	---	--

Coding

	Nr. articol: 2091-1610 Coding key carrier; suitable for 3.5 mm pin spacing; orange	www.wago.com/2091-1610
--	--	--

tools

	Nr. articol: 210-719 Operating tool; Blade: 2.5 x 0.4 mm; with a partially insulated shaft	www.wago.com/210-719
--	--	--

Descărcări

Documentation

Additional Information

Technical explanations	Apr 3, 2019	pdf 3,6 MB	Descărcare
------------------------	-------------	---------------	------------

Supus modificărilor.

WAGO Kontakttechnik GmbH & Co. KG
/Representative Office Romania
Sos. Pipera-Tunari nr. 1/1
building 1, 2nd floor | 077190 Voluntari, Ilfov
Tel.: +40-(0)31 421 85 68 | Email: info-RO@wago.com

Aveți întrebări despre produsele noastre?
Vă stăm la dispoziție pentru preluarea apelului la +40 (0) 31 421 85 68.

Installation Notes

Locking

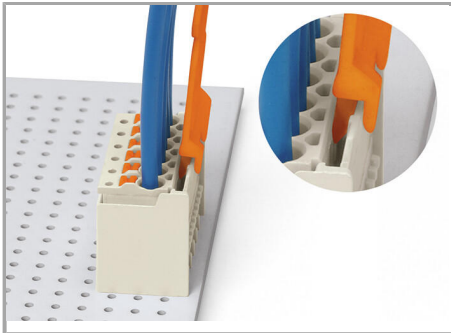

Disconnecting female connector via unlocking tool. Plug unlocking tool into the male locking latch.

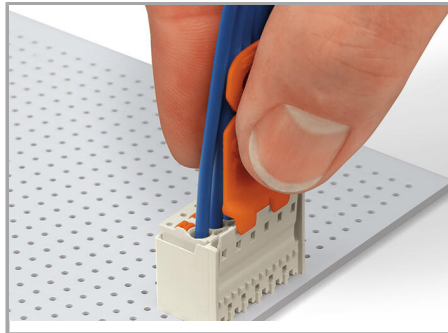

Insert unlocking tool until it hits backstop. Wedge opens locking latch.

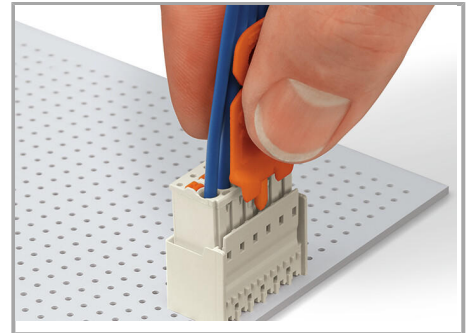

Pull on both unlocking tool and conductors to remove female connector from male header.

Conductor termination

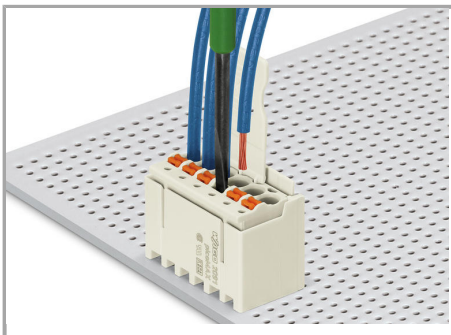

Inserting fine-stranded conductor into mated female connector via push-button.

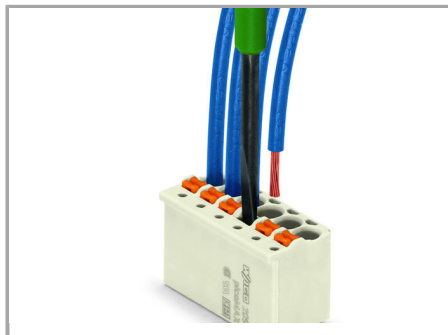

Inserting fine-stranded conductor into unmated female connector via push-button.

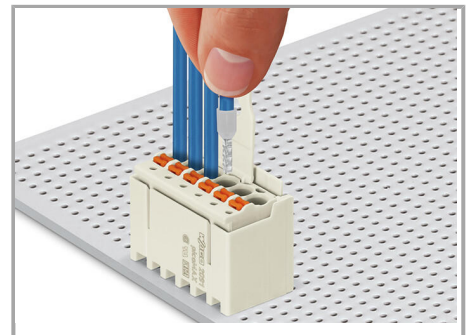

Inserting solid and ferruled conductors via push-in termination

Marking



Pole marking via factory direct printing.

Supus modificărilor.

Coding

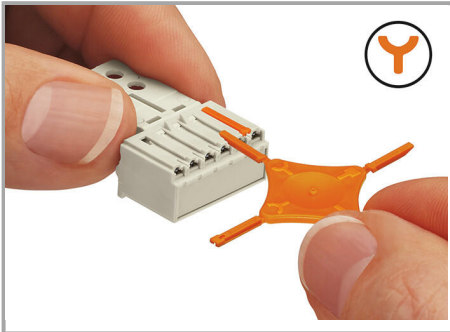

Coding a female connector (via coding key carrier and two keys for female connector, see symbol).

Testing

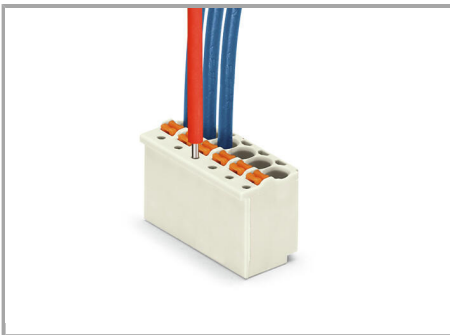

Testing with 1 mm Ø test pin, tip contact.

Familie de produse

picoMAX

Afișare globală produse din familie.

Supus modificărilor.