

Fișă tehnică | Număr articol: 2007-8801/044-000

2-conductor through terminal block; 6 mm²; with touch-proof test socket; for 4 mm Ø test plugs; side and center marking; for DIN-rail 35 x 15 and 35 x 7.5; Push-in CAGE CLAMP®; 6,00 mm²; gray

www.wago.com/2007-8801/044-000

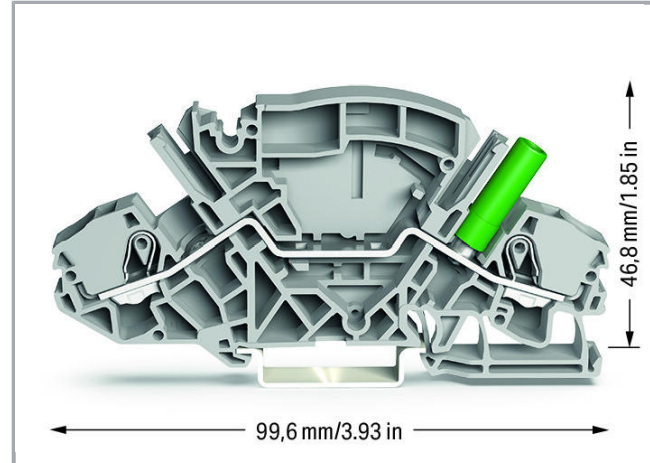
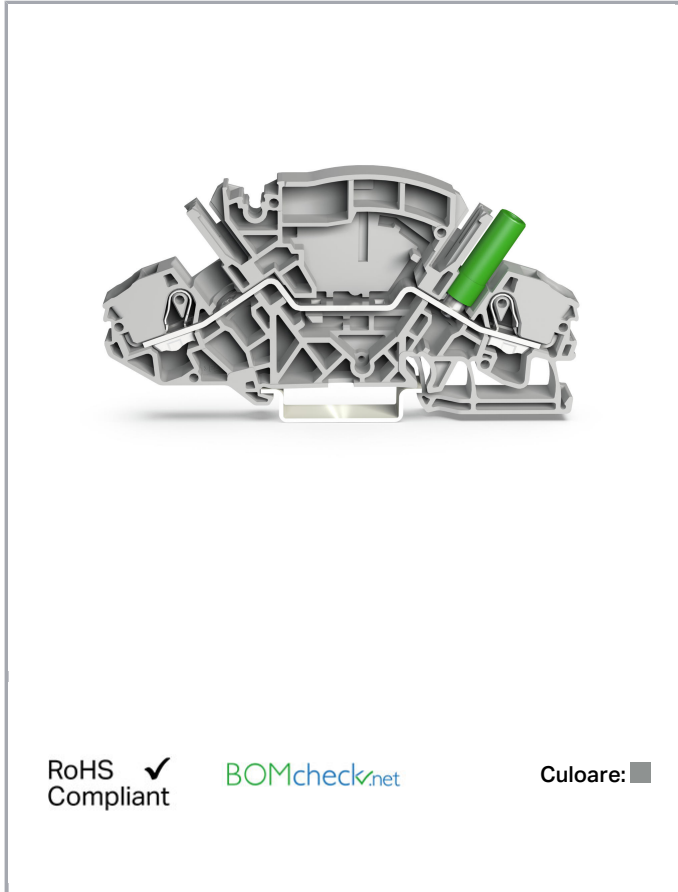

RoHS
Compliant ✓

BOMcheck.net

Culoare: ■

Date

Electrical data

Ratings per IEC/EN 60664-1

Nominal voltage (III/3)	500 V
Rated surge voltage (III/3)	6 kV
Rated current	30 A
Legend (ratings)	(III / 3) ≙ Overvoltage category III / Pollution degree 3

Supus modificărilor.

WAGO Kontakttechnik GmbH & Co. KG
/Representative Office Romania
Sos. Pipera-Tunari nr. 1/1
building 1, 2nd floor | 077190 Voluntari, Ilfov
Tel.: +40-(0)31 421 85 68 | Email: info-RO@wago.com

Aveți întrebări despre produsele noastre?
Vă stăm la dispoziție pentru preluarea apelului la +40 (0) 31 421 85 68.



Approvals per UL 1059

Rated voltage UL (Use Group B)	300 V
Rated current UL (Use Group B)	30 A
Rated voltage UL (Use Group C)	300 V
Rated current UL (Use Group C)	30 A
Rated voltage UL (Use Group D)	300 V
Rated current UL (Use Group D)	10 A
Approvals per	UL 1059

Connection data

Connection technology	Push-in CAGE CLAMP®
Actuation type	Push-in Open Tool Slot
Connectable conductor materials	Copper
Nominal cross-section	6 mm ²
Solid conductor	0,5 ... 10 mm ² / 20 ... 8 AWG
Solid conductor; push-in termination	1 ... 10 mm ² / 14 ... 8 AWG
Fine-stranded conductor	0,5 ... 10 mm ² / 20 ... 8 AWG
Fine-stranded conductor; with insulated ferrule	2,5 ... 6 mm ² / 16 ... 10 AWG
Fine-stranded conductor; with uninsulated ferrule	1,5 ... 6 mm ² / 16 ... 10 AWG
Fine-stranded conductor; with ferrule; push-in termination	2,5 ... 6 mm ² / 16 ... 14 AWG
Strip length	13 ... 15 mm / 0.51 ... 0.59 inch
Total number of connection points	2
Number of levels	1
Wiring type	Front-entry wiring
Number of jumper slots	2

Geometrical Data

Width	8 mm / 0.315 inch
Height from upper-edge of DIN-rail	46,8 mm / 1.843 inch
Depth	99,6 mm / 3.921 inch

Mechanical data

Design	angled
Mounting type	DIN-35 rail

Supus modificărilor.

WAGO Kontakttechnik GmbH & Co. KG
/Representative Office Romania
Sos. Pipera-Tunari nr. 1/1
building 1, 2nd floor | 077190 Voluntari, Ilfov
Tel.: +40-(0)31 421 85 68 | Email: info-RO@wago.com

Aveți întrebări despre produsele noastre?
Vă stăm la dispoziție pentru preluarea apelului la +40 (0) 31 421 85 68.

Marking level	Center/side marking
---------------	---------------------

Material Data



Color	gray
Insulation material	Polyamide 66 (PA 66)
Weight	21,9g

Commercial data

Packaging type	BOX
Country of origin	CN
GTIN	4055143300223
Customs tariff number	85369010000

Aprobări / certificate

Country specific Approvals

Emblemă	Aprobare	Text de aprobare suplimentar	Nume certificat
	CCA DEKRA Certification B.V.	EN 60947	2198208.01
	CSA DEKRA Certification B.V.	C22.2 No. 158	70009679

Ship Approvals

Emblemă	Aprobare	Text de aprobare suplimentar	Nume certificat
	DNV GL Det Norske Veritas, Germanischer Lloyd	-	TAE00001V2

UL-Approvals

Emblemă	Aprobare	Text de aprobare suplimentar	Nume certificat
	cURus UL International Germany GmbH	UL 1059	E45172

Supus modificărilor.







WAGO Kontakttechnik GmbH & Co. KG
/Representative Office Romania
Sos. Pipera-Tunari nr. 1/1
building 1, 2nd floor | 077190 Voluntari, Ilfov
Tel.: +40-(0)31 421 85 68 | Email: info-RO@wago.com

Aveți întrebări despre produsele noastre?
Vă stăm la dispoziție pentru preluarea apelului la +40 (0) 31 421 85 68.

Counterpart

Produse compatibile

ferrule

	Nr. articol: 216-208 Ferrule; Sleeve for 6 mm ² / AWG 10; insulated; electro-tin plated; electrolytic copper; gastight crimped; acc. to DIN 46228, Part 4/09.90; yellow	www.wago.com/216-208
	Nr. articol: 216-262 Ferrule; Sleeve for 0.75 mm ² / 18 AWG; insulated; electro-tin plated; electrolytic copper; gastight crimped; acc. to DIN 46228, Part 4/09.90; gray	www.wago.com/216-262
	Nr. articol: 216-263 Ferrule; Sleeve for 1 mm ² / AWG 18; insulated; electro-tin plated; electrolytic copper; gastight crimped; acc. to DIN 46228, Part 4/09.90; red	www.wago.com/216-263
	Nr. articol: 216-264 Ferrule; Sleeve for 1.5 mm ² / AWG 16; insulated; electro-tin plated; electrolytic copper; gastight crimped; acc. to DIN 46228, Part 4/09.90; black	www.wago.com/216-264
	Nr. articol: 216-266 Ferrule; Sleeve for 2.5 mm ² / AWG 14; insulated; electro-tin plated; electrolytic copper; gastight crimped; acc. to DIN 46228, Part 4/09.90; blue	www.wago.com/216-266
	Nr. articol: 216-267 Ferrule; Sleeve for 4 mm ² / AWG 12; insulated; electro-tin plated; electrolytic copper; gastight crimped; acc. to DIN 46228, Part 4/09.90; gray	www.wago.com/216-267













Marking accessories

	Nr. articol: 2009-110 Marking strips; on reel; not stretchable; plain; snap-on type; white	www.wago.com/2009-110
	Nr. articol: 2009-115 WMB-Inline; for Smart Printer; 1500 pieces on roll; stretchable 5 - 5.2 mm; plain; snap-on type; white	www.wago.com/2009-115
	Nr. articol: 2009-115/000-002 WMB-Inline; for Smart Printer; 1500 pieces on roll; stretchable 5 - 5.2 mm; plain; snap-on type; yellow	www.wago.com/2009-115/000-002
	Nr. articol: 2009-115/000-006 WMB-Inline; for Smart Printer; 1500 pieces on roll; stretchable 5 - 5.2 mm; plain; snap-on type; blue	www.wago.com/2009-115/000-006

Supus modificărilor.

WAGO Kontakttechnik GmbH & Co. KG
/Representative Office Romania
Sos. Pipera-Tunari nr. 1/1
building 1, 2nd floor | 077190 Voluntari, Ilfov
Tel.: +40-(0)31 421 85 68 | Email: info-RO@wago.com

Aveți întrebări despre produsele noastre?
Vă stăm la dispoziție pentru preluarea apelului la +40 (0) 31 421 85 68.

	Nr. articol: 2009-115/000-007 WMB-Inline; for Smart Printer; 1500 pieces on roll; stretchable 5 - 5.2 mm; plain; snap-on type; gray	www.wago.com/2009-115/000-007
	Nr. articol: 2009-115/000-012 WMB-Inline; for Smart Printer; 1500 pieces on roll; stretchable 5 - 5.2 mm; plain; snap-on type; orange	www.wago.com/2009-115/000-012
	Nr. articol: 2009-115/000-017 WMB-Inline; for Smart Printer; 1500 pieces on roll; stretchable 5 - 5.2 mm; plain; snap-on type; light green	www.wago.com/2009-115/000-017
	Nr. articol: 2009-115/000-023 WMB-Inline; for Smart Printer; 1500 pieces on roll; stretchable 5 - 5.2 mm; plain; snap-on type; green	www.wago.com/2009-115/000-023
	Nr. articol: 2009-115/000-024 WMB-Inline; for Smart Printer; 1500 pieces on roll; stretchable 5 - 5.2 mm; plain; snap-on type; violet	www.wago.com/2009-115/000-024
	Nr. articol: 2009-198 Adaptor	www.wago.com/2009-198
	Nr. articol: 793-501 WMB marking card; as card; not stretchable; plain; snap-on type; white	www.wago.com/793-501
	Nr. articol: 793-501/000-002 WMB marking card; as card; not stretchable; plain; snap-on type; yellow	www.wago.com/793-501/000-002
	Nr. articol: 793-501/000-005 WMB marking card; as card; not stretchable; plain; snap-on type; red	www.wago.com/793-501/000-005
	Nr. articol: 793-501/000-006 WMB marking card; as card; not stretchable; plain; snap-on type; blue	www.wago.com/793-501/000-006
	Nr. articol: 793-501/000-007 WMB marking card; as card; not stretchable; plain; snap-on type; gray	www.wago.com/793-501/000-007
	Nr. articol: 793-501/000-012 WMB marking card; as card; not stretchable; plain; snap-on type; orange	www.wago.com/793-501/000-012
	Nr. articol: 793-501/000-017 WMB marking card; as card; not stretchable; plain; snap-on type; light green	www.wago.com/793-501/000-017
	Nr. articol: 793-501/000-023 WMB marking card; as card; not stretchable; plain; snap-on type; green	www.wago.com/793-501/000-023

Supus modificărilor.



Nr. articol: 793-501/000-024
WMB marking card; as card; not stretchable; plain; snap-on type; violet

www.wago.com/793-501/000-024

Protective Warning Marker



Nr. articol: 2006-115
Protective warning marker; with high-voltage symbol, black; for 5 terminal blocks; yellow

www.wago.com/2006-115

Carrier rail



Nr. articol: 210-112
Steel carrier rail; 35 x 7.5 mm; 1 mm thick; 2 m long; slotted; according to EN 60715; "Hole width 25 mm

www.wago.com/210-112



Nr. articol: 210-113
Steel carrier rail; 35 x 7.5 mm; 1 mm thick; 2 m long; unslotted; according to EN 60715

www.wago.com/210-113

Nr. articol: 210-114
Steel carrier rail; 35 x 15 mm; 1.5 mm thick; 2 m long; unslotted; similar to EN 60715

www.wago.com/210-114



Nr. articol: 210-115
Steel carrier rail; 35 x 7.5 mm; 1 mm thick; 2 m long; slotted; according to EN 60715; "Hole width 18 mm

www.wago.com/210-115

Nr. articol: 210-118
Steel carrier rail; 35 x 15 mm; 2.3 mm thick; 2 m long; unslotted; according to EN 60715

www.wago.com/210-118

Nr. articol: 210-196
Aluminum carrier rail; 35 x 8.2 mm; 1.6 mm thick; 2 m long; unslotted; similar to EN 60715; silver-colored

www.wago.com/210-196

Nr. articol: 210-197
Steel carrier rail; 35 x 15 mm; 1.5 mm thick; 2 m long; slotted; similar to EN 60715

www.wago.com/210-197

Nr. articol: 210-198
Copper carrier rail; 35 x 15 mm; 2.3 mm thick; 2 m long; unslotted; according to EN 60715; copper-colored

www.wago.com/210-198

tools



Nr. articol: 210-721
Operating tool; Blade: 5.5 x 0.8 mm; with a partially insulated shaft

www.wago.com/210-721

Jumper



Nr. articol: 282-432
Jumper; insulated; 2-way; Nominal current 30 A; orange

www.wago.com/282-432



Nr. articol: 282-432/100-000
Jumper with safety lid; insulated; 2-way; Nominal current 30 A; orange

www.wago.com/282-432/100-000



Nr. articol: 282-433
Jumper; insulated; 3-way; Nominal current 30 A; orange

www.wago.com/282-433

















Nr. articol: 282-433/100-000
Jumper with safety lid; insulated; 3-way; Nominal current 30 A; orange

www.wago.com/282-433/100-000

Supus modificărilor.

WAGO Kontakttechnik GmbH & Co. KG
/Representative Office Romania
Sos. Pipera-Tunari nr. 1/1
building 1, 2nd floor | 077190 Voluntari, Ilfov
Tel.: +40-(0)31 421 85 68 | Email: info-RO@wago.com

Aveți întrebări despre produsele noastre?
Vă stăm la dispoziție pentru preluarea apelului la +40 (0) 31 421 85 68.

	Nr. articol: 282-434 Jumper; insulated; 4-way; Nominal current 30 A; orange	www.wago.com/282-434
	Nr. articol: 282-434/100-000 Jumper with safety lid; insulated; 4-way; Nominal current 30 A; orange	www.wago.com/282-434/100-000
	Nr. articol: 282-435 Jumper; insulated; 5-way; Nominal current 30 A; orange	www.wago.com/282-435
	Nr. articol: 282-435/011-000 Jumper; insulated; 3-way (1-3-5); Nominal current 30 A; special version; orange	www.wago.com/282-435/011-000
	Nr. articol: 282-435/300-000 Jumper; insulated; Nominal current 30 A; orange	www.wago.com/282-435/300-000
	Nr. articol: 282-435/301-000 Jumper; orange	www.wago.com/282-435/301-000
	Nr. articol: 282-436 Jumper; insulated; 6-way; Nominal current 30 A; orange	www.wago.com/282-436
	Nr. articol: 282-436/301-000 Jumper; insulated; 1-2-4-6; Nominal current 30 A; special version; orange	www.wago.com/282-436/301-000
	Nr. articol: 282-436/304-000 Jumper; orange	www.wago.com/282-436/304-000
	Nr. articol: 282-437 Jumper; insulated; 7-way; Nominal current 30 A; orange	www.wago.com/282-437
	Nr. articol: 282-437/011-000 Jumper; insulated; 1-3-5-7; Nominal current 30 A; special version; orange	www.wago.com/282-437/011-000
	Nr. articol: 282-437/012-000 Jumper; insulated; 1-4-7; Nominal current 30 A; special version; orange	www.wago.com/282-437/012-000
	Nr. articol: 282-438 Jumper; insulated; 8-way; Nominal current 30 A; orange	www.wago.com/282-438
	Nr. articol: 282-438/300-000 Jumper; insulated; 1-2-5-8; Nominal current 30 A; special version; orange	www.wago.com/282-438/300-000
	Nr. articol: 282-438/301-000 Jumper; insulated; 1-4-7-8; Nominal current 30 A; special version; orange	www.wago.com/282-438/301-000

Supus modificărilor.

**Nr. articol: 282-439**

Jumper; insulated; 9-way; Nominal current 30 A; orange

www.wago.com/282-439**Nr. articol: 282-439/011-000**

Jumper; insulated; 1-3-5-7-9; Nominal current 30 A; special version; orange

www.wago.com/282-439/011-000**Nr. articol: 282-440**

Jumper; insulated; 10-way; Nominal current 30 A; orange

www.wago.com/282-440

Descărcări

Documentation

Additional Information

Technical explanations

Apr 3, 2019

pdf
2,1 MB

Descărcare

CAD/CAE-Data

CAD data

2D/3D Models 2007-8801/044-000

URL

Descărcare

CAE data

EPLAN Data Portal 2007-8801/044-000

URL

Descărcare

WSCAD Universe 2007-8801/044-000

URL

Descărcare

Installation Notes

Conductor termination

Supus modificărilor.

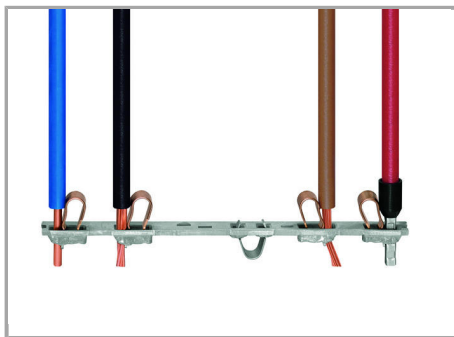

All conductor types at a glance

Commoning

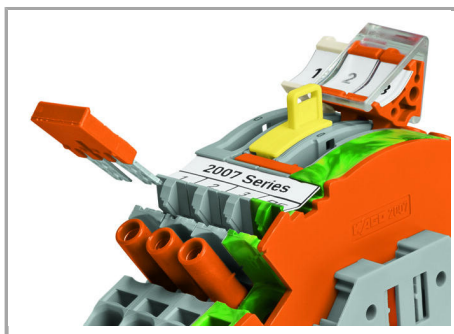

Additional commoning option on the transformer side

Safety

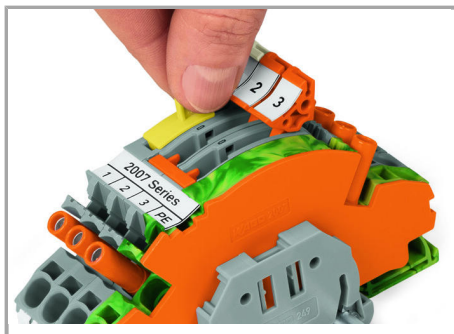

Lock-out prevents accidental operation of disconnect link.

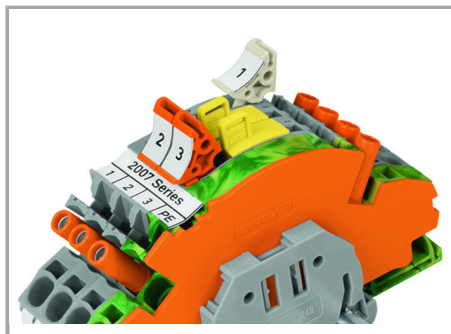

Lock-out snaps into one of two notched positions.

Locking lever

Supus modificărilor.

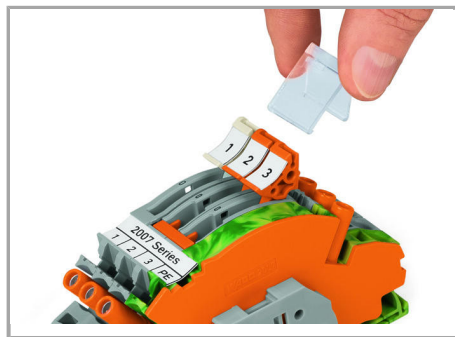

Using locking covers or profiles for adjacent terminal blocks allows disconnect links to be operated simultaneously.

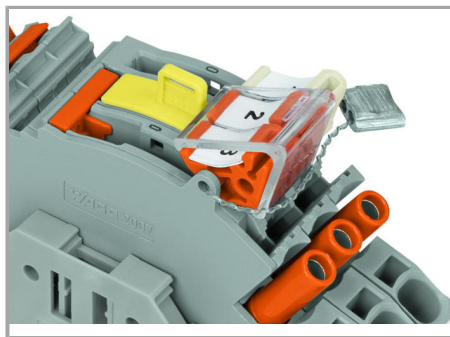

A lock-out seal can be used on the disconnect link in operating position I in combination with an end and separator plate (2007-8893 or 2007-8894).

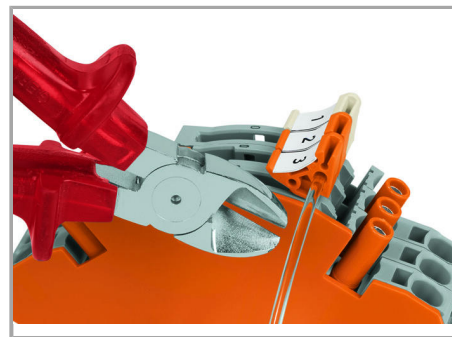

Interlocking link mechanically locks multiple links for multi-pole switching applications.

Marking

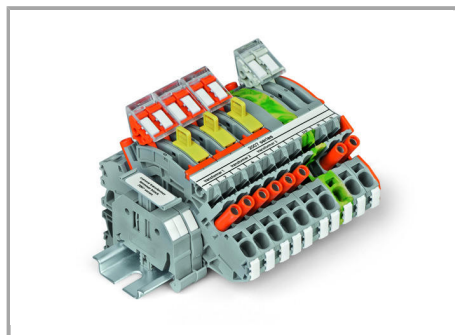

Marking via WMB Multi markers or marking strips.

Familie de produse

TOPJOB® S

TOPJOB® S: In various industrial applications and modern building installations, WAGO's wide and versatile range of rail-mount terminal blocks provides more than just reliable electrical connections.

[Afișare globală produse din familie.](#)

Supus modificărilor.