

Fișă tehnică | Număr articol: 2000-2233/099-000

Double-deck terminal block; Through/through terminal block; with end plate; L/N; with marker carrier; Blue conductor entry upper deck; for DIN-rail 35 x 15 and 35 x 7.5; 1 mm²; Push-in CAGE CLAMP®; 1,00 mm²; gray

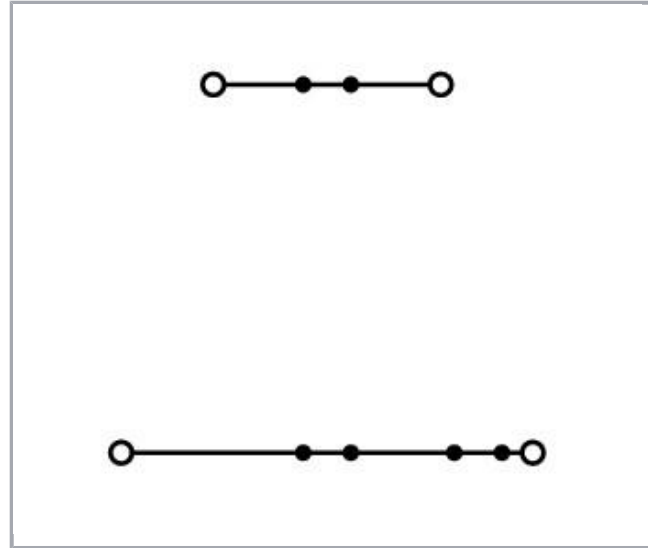

www.wago.com/2000-2233/099-000

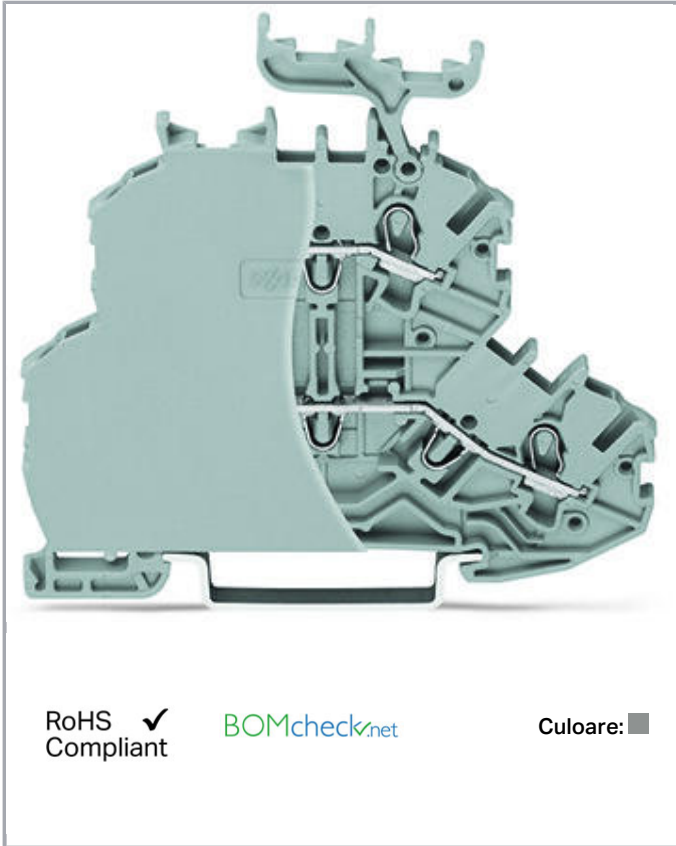

RoHS Compliant

[BOMcheck.net](https://www.bomcheck.net)

Culoare: ■

Date

Electrical data

Ratings per IEC/EN 60664-1

Ratings per	IEC/EN 60947-7-1
Nominal voltage (III/3)	800 V
Rated surge voltage (III/3)	8 kV
Rated current	13,5 A
Rated current 2	16 A
Legend (ratings)	(III / 3) ≙ Overvoltage category III / Pollution degree 3

Supus modificărilor.

WAGO Kontakttechnik GmbH & Co. KG
/Representative Office Romania
Sos. Pipera-Tunari nr. 1/1
building 1, 2nd floor | 077190 Voluntari, Ilfov
Tel.: +40-(0)31 421 85 68 | Email: info-RO@wago.com

Aveți întrebări despre produsele noastre?
Vă stăm la dispoziție pentru preluarea apelului la +40 (0) 31 421 85 68.



Approvals per UL 1059

Rated voltage UL (Use Group B)	600 V
Rated current UL (Use Group B)	15 A
Rated voltage UL (Use Group C)	600 V
Rated current UL (Use Group C)	15 A
Approvals per	UL 1059

Connection data

Connection technology	Push-in CAGE CLAMP®
Number of connection points (connection type)	2
Actuation type	Push-in Open Tool Slot
Connectable conductor materials	Copper
Nominal cross-section	1 mm ²
Solid conductor	0,14 ... 1,5 mm ² / 24 ... 16 AWG
Solid conductor; push-in termination	0,5 ... 1,5 mm ² / 20 ... 16 AWG
Fine-stranded conductor	0,14 ... 1,5 mm ² / 24 ... 16 AWG
Fine-stranded conductor; with insulated ferrule	0,5 ... 0,75 mm ² / 20 ... 18 AWG
Fine-stranded conductor; with ferrule; push-in termination	0,5 ... 0,75 mm ² / 20 ... 18 AWG
Strip length	9 ... 11 mm / 0.35 ... 0.43 inch
Number of connection points	2
Total number of connection points	4
Total number of potentials	2
Number of levels	2
Wiring type	Front-entry wiring
Note (conductor cross-section)	Depending on the conductor characteristic, a conductor with a smaller cross-section can also be inserted via push-in termination.

Geometrical Data

Width	4,2 mm / 0.165 inch
Height from upper-edge of DIN-rail	61,8 mm / 2.433 inch
Depth	69,7 mm / 2.744 inch

Mechanical data

Design	horizontal type
--------	-----------------

Supus modificărilor.

WAGO Kontakttechnik GmbH & Co. KG
/Representative Office Romania
Sos. Pipera-Tunari nr. 1/1
building 1, 2nd floor | 077190 Voluntari, Ilfov
Tel.: +40-(0)31 421 85 68 | Email: info-RO@wago.com

Aveți întrebări despre produsele noastre?
Vă stăm la dispoziție pentru preluarea apelului la +40 (0) 31 421 85 68.

Mounting type	DIN-35 rail
Potential marking	L/N
Marking level	Center/side marking

Material Data

Color	gray
Insulation material	Polyamide 66 (PA 66)
Fire load	0,226 MJ
Weight	9,6 g

Commercial data

Product Group	22 (TOPJOB S)
Packaging type	BOX
Country of origin	DE
GTIN	4050821037675
Customs tariff number	85369010000

Aprobări / certificate

Ex-Approvals

Emblemă	Aprobare	Text de aprobare suplimentar	Nume certificat
	AEx Underwriters Laboratories Inc.	UL 60079	E185892

Country specific Approvals

Emblemă	Aprobare	Text de aprobare suplimentar	Nume certificat
	CCA DEKRA Certification B.V.	EN 60947	NTR NL 7671
	CCA DEKRA Certification B.V.	EN 60947	71- 102841

Supus modificărilor.











WAGO Kontakttechnik GmbH & Co. KG
/Representative Office Romania
Sos. Pipera-Tunari nr. 1/1
building 1, 2nd floor | 077190 Voluntari, Ilfov
Tel.: +40-(0)31 421 85 68 | Email: info-RO@wago.com

Aveți întrebări despre produsele noastre?
Vă stăm la dispoziție pentru preluarea apelului la +40 (0) 31 421 85 68.

Counterpart

Produse compatibile

















Marking accessories

	Nr. articol: 2000-121 Adaptor	www.wago.com/2000-121
	Nr. articol: 2009-110 Marking strips; on reel; not stretchable; plain; snap-on type; white	www.wago.com/2009-110
	Nr. articol: 2009-113 WMB-Inline; for Smart Printer; 2300 pieces on roll; plain; snap-on type; white	www.wago.com/2009-113
	Nr. articol: 2009-113/000-002 WMB-Inline; for Smart Printer; 2300 pieces on roll; plain; snap-on type; yellow	www.wago.com/2009-113/000-002
	Nr. articol: 2009-113/000-005 WMB-Inline; for Smart Printer; 2300 pieces on roll; plain; snap-on type; red	www.wago.com/2009-113/000-005
	Nr. articol: 2009-113/000-006 WMB-Inline; for Smart Printer; 2300 pieces on roll; plain; snap-on type; blue	www.wago.com/2009-113/000-006
	Nr. articol: 2009-113/000-007 WMB-Inline; for Smart Printer; 2300 pieces on roll; plain; snap-on type; gray	www.wago.com/2009-113/000-007
	Nr. articol: 2009-113/000-012 WMB-Inline; for Smart Printer; 2300 pieces on roll; plain; snap-on type; orange	www.wago.com/2009-113/000-012
	Nr. articol: 2009-113/000-017 WMB-Inline; for Smart Printer; 2300 pieces on roll; plain; snap-on type; light green	www.wago.com/2009-113/000-017
	Nr. articol: 2009-113/000-023 WMB-Inline; for Smart Printer; 2300 pieces on roll; plain; snap-on type; green	www.wago.com/2009-113/000-023

Supus modificărilor.











WAGO Kontakttechnik GmbH & Co. KG
 /Representative Office Romania
 Sos. Pipera-Tunari nr. 1/1
 building 1, 2nd floor | 077190 Voluntari, Ilfov
 Tel.: +40-(0)31 421 85 68 | Email: info-RO@wago.com

Aveți întrebări despre produsele noastre?
 Vă stăm la dispoziție pentru preluarea apelului la +40 (0) 31 421 85 68.

	Nr. articol: 2009-113/000-024 WMB-Inline; for Smart Printer; 2300 pieces on roll; plain; snap-on type; violet	www.wago.com/2009-113/000-024
	Nr. articol: 793-3501 WMB marking card; as card; plain; snap-on type; white	www.wago.com/793-3501
Push-In type wire jumper		
	Nr. articol: 2009-402 Push-in type wire jumper; insulated; wire length 60 mm; Conductor cross section 0.75 mm ² ; suitable for 2000 and 2020 Series rail-mounted terminal blocks; gray	www.wago.com/2009-402
	Nr. articol: 2009-404 Push-in type wire jumper; insulated; wire length 110 mm; Conductor cross section 0.75 mm ² ; suitable for 2000 and 2020 Series rail-mounted terminal blocks; gray	www.wago.com/2009-404
	Nr. articol: 2009-406 Push-in type wire jumper; insulated; wire length 250 mm; Conductor cross section 0.75 mm ² ; suitable for 2000 and 2020 Series rail-mounted terminal blocks; gray	www.wago.com/2009-406
check		
	Nr. articol: 2000-510 TOPJOB®S L-type test plug module; modular; for jumper contact slot; 1,00 mm ² ; gray	www.wago.com/2000-510
	Nr. articol: 2000-511 TOPJOB®S L-type test plug module; modular; for jumper contact slot; 1-pole; 1,00 mm ² ; gray	www.wago.com/2000-511
	Nr. articol: 2000-549 Spacer module; modular; e.g., for bridging commoned terminal blocks; gray	www.wago.com/2000-549
	Nr. articol: 2000-552 Modular TOPJOB®S connector; modular; for jumper contact slot; 2-pole; 1,00 mm ² ; gray	www.wago.com/2000-552
	Nr. articol: 2000-553 Modular TOPJOB®S connector; modular; for jumper contact slot; 3-pole; 1,00 mm ² ; gray	www.wago.com/2000-553
	Nr. articol: 2000-554 Modular TOPJOB®S connector; modular; for jumper contact slot; 4-pole; 1,00 mm ² ; gray	www.wago.com/2000-554
	Nr. articol: 2000-555 Modular TOPJOB®S connector; modular; for jumper contact slot; 5-pole; 1,00 mm ² ; gray	www.wago.com/2000-555
	Nr. articol: 2000-556 Modular TOPJOB®S connector; modular; for jumper contact slot; 6-pole; 1,00 mm ² ; gray	www.wago.com/2000-556
	Nr. articol: 2000-557 Modular TOPJOB®S connector; modular; for jumper contact slot; 7-pole; 1,00 mm ² ; gray	www.wago.com/2000-557
	Nr. articol: 2000-558 Modular TOPJOB®S connector; modular; for jumper contact slot; 8-pole; 1,00 mm ² ; gray	www.wago.com/2000-558
	Nr. articol: 2000-559 Modular TOPJOB®S connector; modular; for jumper contact slot; 9-pole; 1,00 mm ² ; gray	www.wago.com/2000-559

Nr. articol: 2000-560

Supus modificărilor.

	Modular TOPJOB®S connector; modular; for jumper contact slot; 10-pole; 1,00 mm ² ; gray	www.wago.com/2000-560
	Nr. articol: 2009-174 Test plug adapter; for 4 mm Ø test plugs; for testing TOPJOB®S rail-mounted terminal blocks; gray	www.wago.com/2009-174
	Nr. articol: 2009-182 Testing tap; for max. 2.5 mm ² ; tool-free connection for individual test wires 0.08 - 2.5 mm; gray	www.wago.com/2009-182
	Nr. articol: 210-136 Test plug; 2 mm Ø; with 500 mm cable; red	www.wago.com/210-136
	Nr. articol: 210-137 Test plug; 2.3 mm Ø; with 500 mm cable; yellow	www.wago.com/210-137
Protective Warning Marker		
	Nr. articol: 2001-115 Protective warning marker; with high-voltage symbol, black; for 5 terminal blocks; yellow	www.wago.com/2001-115
ferrule		
	Nr. articol: 216-241 Ferrule; Sleeve for 0.5 mm ² / 20 AWG; insulated; electro-tin plated; electrolytic copper; gastight crimped; acc. to DIN 46228, Part 4/09.90; white	www.wago.com/216-241
	Nr. articol: 216-242 Ferrule; Sleeve for 0.75 mm ² / 18 AWG; insulated; electro-tin plated; electrolytic copper; gastight crimped; acc. to DIN 46228, Part 4/09.90; gray	www.wago.com/216-242
	Nr. articol: 216-243 Ferrule; Sleeve for 1 mm ² / AWG 18; insulated; electro-tin plated; electrolytic copper; gastight crimped; acc. to DIN 46228, Part 4/09.90; red	www.wago.com/216-243
Carrier rail		
	Nr. articol: 210-112 Steel carrier rail; 35 x 7.5 mm; 1 mm thick; 2 m long; slotted; according to EN 60715; "Hole width 25 mm	www.wago.com/210-112
	Nr. articol: 210-113 Steel carrier rail; 35 x 7.5 mm; 1 mm thick; 2 m long; unslotted; according to EN 60715	www.wago.com/210-113
	Nr. articol: 210-114 Steel carrier rail; 35 x 15 mm; 1.5 mm thick; 2 m long; unslotted; similar to EN 60715	www.wago.com/210-114
	Nr. articol: 210-115 Steel carrier rail; 35 x 7.5 mm; 1 mm thick; 2 m long; slotted; according to EN 60715; "Hole width 18 mm	www.wago.com/210-115
	Nr. articol: 210-118 Steel carrier rail; 35 x 15 mm; 2.3 mm thick; 2 m long; unslotted; according to EN 60715	www.wago.com/210-118
	Nr. articol: 210-196 Aluminum carrier rail; 35 x 8.2 mm; 1.6 mm thick; 2 m long; unslotted; similar to EN 60715; silver-colored	www.wago.com/210-196
	Nr. articol: 210-197 Steel carrier rail; 35 x 15 mm; 1.5 mm thick; 2 m long; slotted; similar to EN 60715	www.wago.com/210-197

Supus modificărilor.

**Nr. articol: 210-198**

Copper carrier rail; 35 x 15 mm; 2.3 mm thick; 2 m long; unslotted; according to EN 60715; copper-colored

www.wago.com/210-198**Jumper****Nr. articol: 2000-492**

Double-deck vertical jumper; insulated; light gray

www.wago.com/2000-492**Nr. articol: 2001-402**

Push-in type jumper bar; insulated; 2-way; Nominal current 18 A; light gray

www.wago.com/2001-402**Nr. articol: 2001-403**

Push-in type jumper bar; insulated; 3-way; Nominal current 18 A; light gray

www.wago.com/2001-403**Nr. articol: 2001-404**

Push-in type jumper bar; insulated; 4-way; Nominal current 18 A; light gray

www.wago.com/2001-404**Nr. articol: 2001-405**

Push-in type jumper bar; insulated; 5-way; Nominal current 18 A; light gray

www.wago.com/2001-405**Nr. articol: 2001-405/011-000**

Star point jumper; insulated; 3-way (1-3-5); IN = IN terminal block; light gray

www.wago.com/2001-405/011-000**Nr. articol: 2001-406**

Push-in type jumper bar; insulated; 6-way; Nominal current 18 A; light gray

www.wago.com/2001-406**Nr. articol: 2001-406/020-000**

Delta jumper; insulated; 1-2 3-4 5-6; IN = IN terminal block; light gray

www.wago.com/2001-406/020-000**Nr. articol: 2001-407**

Push-in type jumper bar; insulated; 7-way; Nominal current 18 A; light gray

www.wago.com/2001-407**Nr. articol: 2001-408**

Push-in type jumper bar; insulated; 8-way; Nominal current 18 A; light gray

www.wago.com/2001-408**Nr. articol: 2001-409**

Push-in type jumper bar; insulated; 9-way; Nominal current 18 A; light gray

www.wago.com/2001-409**Nr. articol: 2001-410**

Push-in type jumper bar; insulated; 10-way; Nominal current 18 A; light gray

www.wago.com/2001-410**Nr. articol: 2001-433**

Push-in type jumper bar; insulated; from 1 to 3; Nominal current 18 A; light gray

www.wago.com/2001-433**Nr. articol: 2001-434**

Push-in type jumper bar; insulated; from 1 to 4; Nominal current 18 A; light gray

www.wago.com/2001-434**Nr. articol: 2001-435**

Push-in type jumper bar; insulated; from 1 to 5; Nominal current 18 A; light gray

www.wago.com/2001-435**Nr. articol: 2001-436**









Push-in type jumper bar; insulated; from 1 to 6; Nominal current 18 A; light gray

www.wago.com/2001-436

Supus modificărilor.

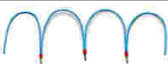
WAGO Kontakttechnik GmbH & Co. KG
 /Representative Office Romania
 Sos. Pipera-Tunari nr. 1/1
 building 1, 2nd floor | 077190 Voluntari, Ilfov
 Tel.: +40-(0)31 421 85 68 | Email: info-RO@wago.com

Aveți întrebări despre produsele noastre?
 Vă stăm la dispoziție pentru preluarea apelului la +40 (0) 31 421 85 68.

	Nr. articol: 2001-437 Push-in type jumper bar; insulated; from 1 to 7; Nominal current 18 A; light gray	www.wago.com/2001-437
	Nr. articol: 2001-438 Push-in type jumper bar; insulated; from 1 to 8; Nominal current 18 A; light gray	www.wago.com/2001-438
	Nr. articol: 2001-439 Push-in type jumper bar; insulated; from 1 to 9; Nominal current 18 A; light gray	www.wago.com/2001-439
	Nr. articol: 2001-440 Push-in type jumper bar; insulated; from 1 to 10; Nominal current 18 A; light gray	www.wago.com/2001-440
	Nr. articol: 210-103 Wire commoning chain; insulated; 50 connections; black	www.wago.com/210-103
	Nr. articol: 210-123 Wire commoning chain; insulated; 50 connections	www.wago.com/210-123
tools		
	Nr. articol: 210-647 Operating tool; Blade: 2.5 x 0.4 mm; with a partially insulated shaft	www.wago.com/210-647
	Nr. articol: 210-648 Operating tool; Blade: 2.5 x 0.4 mm; with a partially insulated shaft; angled; short	www.wago.com/210-648
	Nr. articol: 210-719 Operating tool; Blade: 2.5 x 0.4 mm; with a partially insulated shaft	www.wago.com/210-719

Descărcări

Documentation

Additional Information

Technical explanations	Apr 3, 2019	pdf 2,1 MB	Descărcare
------------------------	-------------	---------------	------------

CAD/CAE-Data

CAD data

2D/3D Models 2000-2233/099-000	URL	Descărcare
--------------------------------	-----	------------

CAE data

EPLAN Data Portal 2000-2233/099-000	URL	Descărcare
-------------------------------------	-----	------------

WSCAD Universe 2000-2233/099-000	URL	Descărcare
----------------------------------	-----	------------

Supus modificărilor.

WAGO Kontakttechnik GmbH & Co. KG
/Representative Office Romania
Sos. Pipera-Tunari nr. 1/1
building 1, 2nd floor | 077190 Voluntari, Ilfov
Tel.: +40-(0)31 421 85 68 | Email: info-RO@wago.com

Aveți întrebări despre produsele noastre?
Vă stăm la dispoziție pentru preluarea apelului la +40 (0) 31 421 85 68.

Installation Notes

Conductor termination

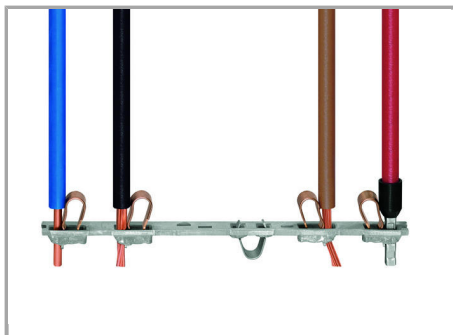

All conductor types at a glance

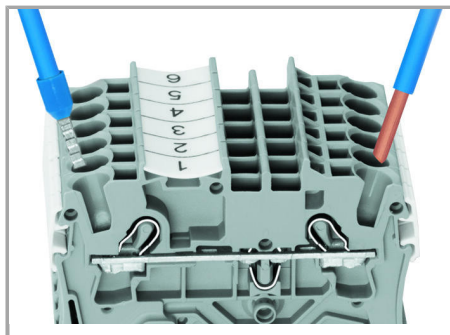

Terminating solid and ferruled conductors via push-in connection.

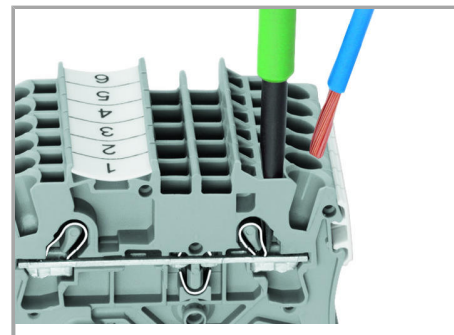

Inserting a conductor via operating tool.

Connecting fine-stranded conductors without ferrules, or small cross-sectional conductors that cannot be pushed in, is performed similarly to the original CAGE CLAMP® – just use an operating tool.

The smart feature:

To open the clamp, the operating tool is inserted vertically. The conductor entry is less than 15 degrees for easier wiring.

Supus modificărilor.

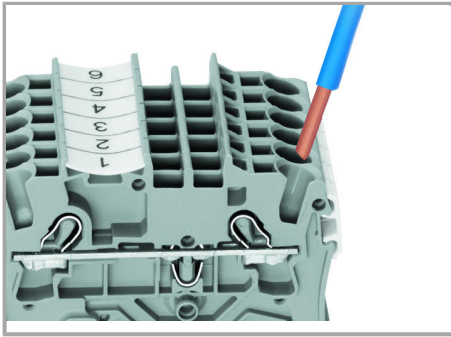

Inserting conductors via push-in termination.

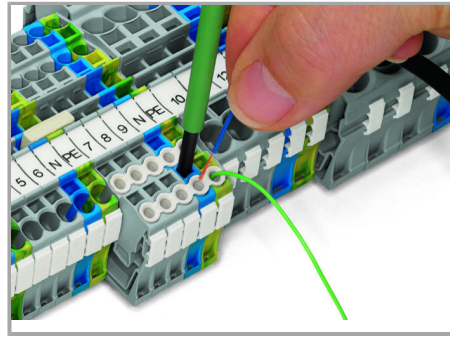

Conductor termination – Insulation stop.

Solid conductors with cross-sections from either one size above, or up to two sizes below, the rated cross-section can be simply pushed in – no tools needed.

Marking

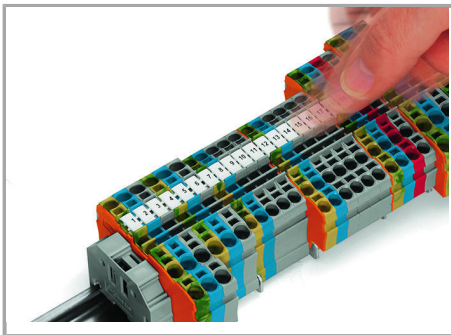

Snapping WMB Inline markers into marker slots.

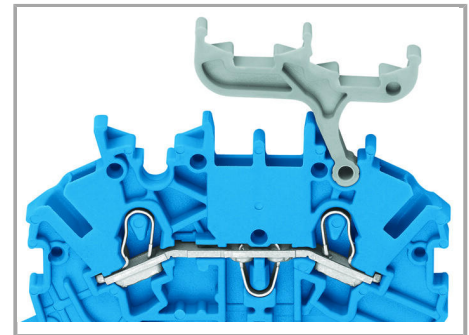
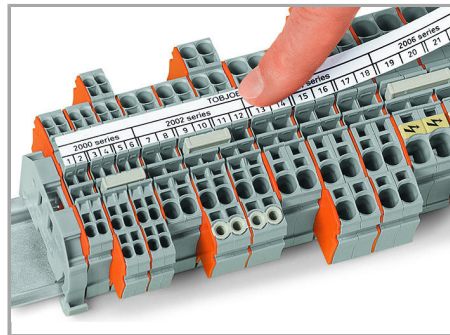

Double-Deck Terminal Blocks

A double-deck marker carrier (2000-121) can be retrofitted to double-deck terminal blocks without a marker carrier.

Familie de produse

TOPJOB® S

TOPJOB® S: In various industrial applications and modern building installations, WAGO's wide and versatile range of rail-mount terminal blocks provides more than just reliable electrical connections.

Afișare globală produse din familie.

Supus modificărilor.

WAGO Kontakttechnik GmbH & Co. KG
/Representative Office Romania
Sos. Pipera-Tunari nr. 1/1
building 1, 2nd floor | 077190 Voluntari, Ilfov
Tel.: +40-(0)31 421 85 68 | Email: info-RO@wago.com

Aveți întrebări despre produsele noastre?
Vă stăm la dispoziție pentru preluarea apelului la +40 (0) 31 421 85 68.