

## Fișă tehnică | Număr articol: 280-681

3-conductor through terminal block; 2.5 mm<sup>2</sup>; center marking; for DIN-rail 35 x 15 and 35 x 7.5; CAGE CLAMP®; 2,50 mm<sup>2</sup>; gray

[www.wago.com/280-681](http://www.wago.com/280-681)

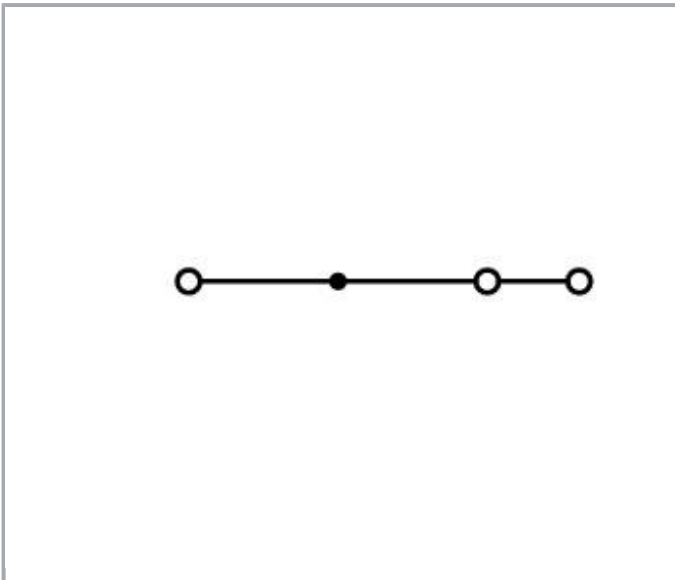
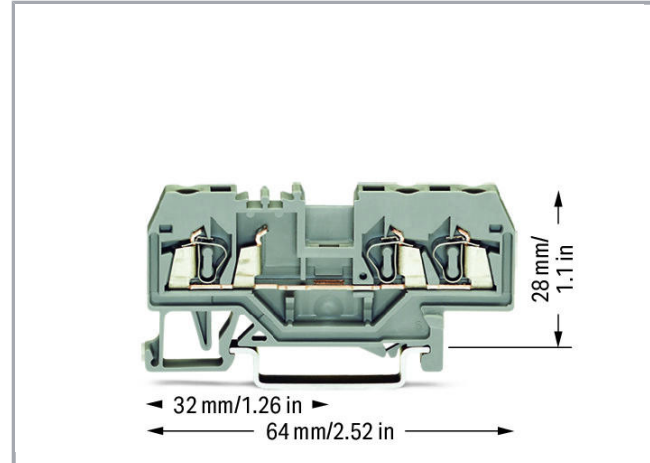
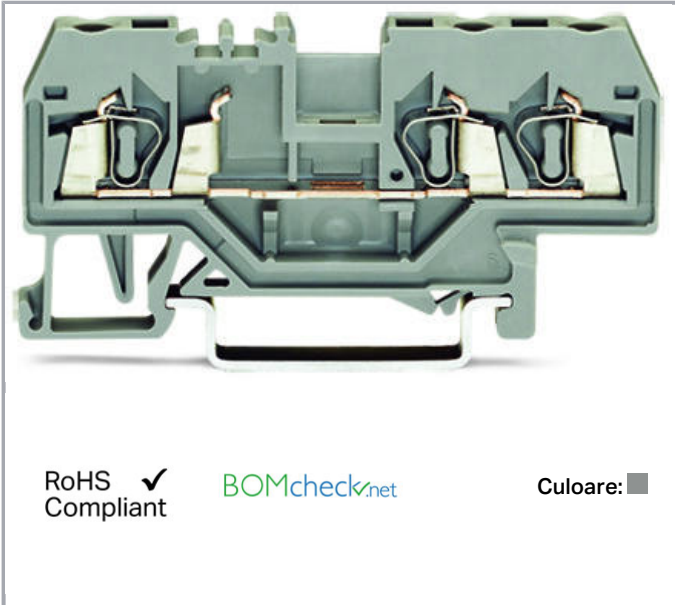

### Descriere articol

#### Note:

##### Terminating Aluminum Conductors

WAGO spring clamp terminal blocks are suitable for solid aluminum conductors up to 4 mm<sup>2</sup>/12 AWG if WAGO "Alu-Plus" Contact Paste is used for

Supus modificărilor.

WAGO Kontakttechnik GmbH & Co. KG  
/Representative Office Romania  
Sos. Pipera-Tunari nr. 1/1  
building 1, 2nd floor | 077190 Voluntari, Ilfov  
Tel.: +40-(0)31 421 85 68 | Email: [info-RO@wago.com](mailto:info-RO@wago.com)

Aveți întrebări despre produsele noastre?

Vă stăm la dispoziție pentru preluarea apelului la +40 (0) 31 421 85 68.

termination.

“Alu-Plus” Contact Paste Advantages:

- Automatically destroys the oxide film during clamping.
- Prevents fresh oxidation at the clamping point.
- Prevents electrolytic corrosion between aluminum and copper conductors (in the same terminal block).
- Provides long-term protection against corrosion.

Using terminal blocks with CAGE CLAMP® Spring Pressure Connection Technology, **aluminum conductors must first be cleaned with a blade and then immediately be inserted into the clamping units filled with “Alu-Plus” Contact Paste.**

It is also possible to apply WAGO “Alu-Plus” **additionally** on the whole surface of the aluminum conductor before termination.

Please note that the nominal currents must be adapted to the reduced conductivity of the aluminum conductors::

2.5 mm<sup>2</sup> = 16 A

4 mm<sup>2</sup> = 22 A

## Date

### Electrical data

#### Ratings per IEC/EN 60664-1

Ratings per	IEC/EN 60947-7-1
Nominal voltage (III/3)	800 V
Rated surge voltage (III/3)	8 kV
Rated current	24 A
Legend (ratings)	(III / 3) ≙ Overvoltage category III / Pollution degree 3

### Connection data

Connection technology	CAGE CLAMP®
Actuation type	Operating tool
Connectable conductor materials	Copper Aluminum
Solid conductor	0,08 ... 2,5 mm <sup>2</sup> / 28 ... 12 AWG
Fine-stranded conductor	0,08 ... 2,5 mm <sup>2</sup> / 28 ... 12 AWG
Strip length	8 ... 9 mm / 0.31 ... 0.35 inch
Total number of connection points	3
Total number of potentials	1
Number of levels	1

Supus modificărilor.

WAGO Kontakttechnik GmbH & Co. KG  
/Representative Office Romania  
Sos. Pipera-Tunari nr. 1/1  
building 1, 2nd floor | 077190 Voluntari, Ilfov  
Tel.: +40-(0)31 421 85 68 | Email: info-RO@wago.com

Aveți întrebări despre produsele noastre?  
Vă stăm la dispoziție pentru preluarea apelului la +40 (0) 31 421 85 68.

Wiring type	Front-entry wiring
Note (conductor cross-section)	12 AWG: THHN, THWN

### Geometrical Data

Width	5 mm / 0.197 inch
Height from upper-edge of DIN-rail	28 mm / 1.102 inch
Depth	64 mm / 2.52 inch

### Mechanical data

Design	horizontal type
Mounting type	DIN-35 rail
Marking level	Center marking

### Material Data



Color	gray
Insulation material	Polyamide 66 (PA 66)
Fire load	0,125 MJ
Weight	7,6 g

### Commercial data

Product Group	1 (Rail Mounted Terminal Blocks)
Packaging type	BOX
Country of origin	DE
GTIN	4044918391306
Customs tariff number	85369010000

### Aprobări / certificate

#### Country specific Approvals





Emblemă	Aprobare	Text de aprobare suplimentar	Nume certificat
	CCA DEKRA Certification B.V.	EN 60947	2157201.01
	CSA DEKRA Certification B.V.	C22.2	1536071

Supus modificărilor.

WAGO Kontakttechnik GmbH & Co. KG  
/Representative Office Romania  
Sos. Pipera-Tunari nr. 1/1  
building 1, 2nd floor | 077190 Voluntari, Ilfov  
Tel.: +40-(0)31 421 85 68 | Email: info-RO@wago.com

Aveți întrebări despre produsele noastre?  
Vă stăm la dispoziție pentru preluarea apelului la +40 (0) 31 421 85 68.

## Ship Approvals

Emblemă	Aprobare	Text de aprobare suplimentar	Nume certificat
	<b>ABS</b> American Bureau of Shipping	EN 60947	20- HG1941090- PDA
 	<b>BV</b> Bureau Veritas S.A.	EN 60947	07436/E0 BV
	<b>DNV GL</b> Det Norske Veritas, Germanischer Lloyd	-	TAE00001V2
	<b>LR</b> Lloyds Register	EN 60947	91/20112 (E9)

## UL-Approvals

Emblemă	Aprobare	Text de aprobare suplimentar	Nume certificat
	<b>UL</b> Underwriters Laboratories Inc.	UL 1059	20170731- E45172

## Counterpart

## Produse compatibile

Supus modificărilor.

WAGO Kontakttechnik GmbH & Co. KG  
/Representative Office Romania  
Sos. Pipera-Tunari nr. 1/1  
building 1, 2nd floor | 077190 Voluntari, Ilfov  
Tel.: +40-(0)31 421 85 68 | Email: info-RO@wago.com

Aveți întrebări despre produsele noastre?  
Vă stăm la dispoziție pentru preluarea apelului la +40 (0) 31 421 85 68.

## assembling

**Nr. articol: 209-106**

Mounting carrier; for isolated mounting on DIN 35 rails; gray

[www.wago.com/209-106](http://www.wago.com/209-106)**Nr. articol: 709-153**

Cover; Type 1; suitable for cover carrier, type 1; 1 m long; transparent

[www.wago.com/709-153](http://www.wago.com/709-153)

## General accessories

**Nr. articol: 231-162/003-000**

Male connector for rail-mount terminal blocks; 1.2 x 1.2 mm pins; straight; Pin spacing 5 mm; 2-pole; gray

[www.wago.com/231-162/003-000](http://www.wago.com/231-162/003-000)**Nr. articol: 231-163/003-000**

Male connector for rail-mount terminal blocks; 1.2 x 1.2 mm pins; straight; Pin spacing 5 mm; 3-pole; gray

[www.wago.com/231-163/003-000](http://www.wago.com/231-163/003-000)**Nr. articol: 231-164/003-000**

Male connector for rail-mount terminal blocks; 1.2 x 1.2 mm pins; straight; Pin spacing 5 mm; 4-pole; gray

[www.wago.com/231-164/003-000](http://www.wago.com/231-164/003-000)**Nr. articol: 231-165/003-000**

Male connector for rail-mount terminal blocks; 1.2 x 1.2 mm pins; straight; Pin spacing 5 mm; 5-pole; gray

[www.wago.com/231-165/003-000](http://www.wago.com/231-165/003-000)**Nr. articol: 231-166/003-000**

Male connector for rail-mount terminal blocks; 1.2 x 1.2 mm pins; straight; Pin spacing 5 mm; 6-pole; gray

[www.wago.com/231-166/003-000](http://www.wago.com/231-166/003-000)**Nr. articol: 231-167/003-000**

Male connector for rail-mount terminal blocks; 1.2 x 1.2 mm pins; straight; Pin spacing 5 mm; 7-pole; gray

[www.wago.com/231-167/003-000](http://www.wago.com/231-167/003-000)**Nr. articol: 231-168/003-000**

Male connector for rail-mount terminal blocks; 1.2 x 1.2 mm pins; straight; Pin spacing 5 mm; 8-pole; gray

[www.wago.com/231-168/003-000](http://www.wago.com/231-168/003-000)**Nr. articol: 231-169/003-000**

Male connector for rail-mount terminal blocks; 1.2 x 1.2 mm pins; straight; Pin spacing 5 mm; 9-pole; gray

[www.wago.com/231-169/003-000](http://www.wago.com/231-169/003-000)**Nr. articol: 231-170/003-000**

Male connector for rail-mount terminal blocks; 1.2 x 1.2 mm pins; straight; Pin spacing 5 mm; 10-pole; gray

[www.wago.com/231-170/003-000](http://www.wago.com/231-170/003-000)**Nr. articol: 231-171/003-000**

Male connector for rail-mount terminal blocks; 1.2 x 1.2 mm pins; straight; Pin spacing 5 mm; 11-pole; gray

[www.wago.com/231-171/003-000](http://www.wago.com/231-171/003-000)**Nr. articol: 231-172/003-000**

Male connector for rail-mount terminal blocks; 1.2 x 1.2 mm pins; straight; Pin spacing 5 mm; 12-pole; gray

[www.wago.com/231-172/003-000](http://www.wago.com/231-172/003-000)

Supus modificărilor.

WAGO Kontakttechnik GmbH &amp; Co. KG

/Representative Office Romania

Sos. Pipera-Tunari nr. 1/1

building 1, 2nd floor | 077190 Voluntari, Ilfov

Tel.: +40-(0)31 421 85 68 | Email: info-RO@wago.com

Aveți întrebări despre produsele noastre?

Vă stăm la dispoziție pentru preluarea apelului la +40 (0) 31 421 85 68.

gray

**Nr. articol: 231-176/003-000**Male connector for rail-mount terminal blocks; 1.2 x 1.2 mm pins; straight; Pin spacing 5 mm; 16-pole; gray [www.wago.com/231-176/003-000](http://www.wago.com/231-176/003-000)**Nr. articol: 231-180/003-000**Male connector for rail-mount terminal blocks; 1.2 x 1.2 mm pins; straight; Pin spacing 5 mm; 20-pole; gray [www.wago.com/231-180/003-000](http://www.wago.com/231-180/003-000)**Nr. articol: 231-668**Lockout caps; for covering unused clamping units; gray [www.wago.com/231-668](http://www.wago.com/231-668)**Nr. articol: 231-669**Lockout caps; for covering unused clamping units; orange [www.wago.com/231-669](http://www.wago.com/231-669)**Nr. articol: 721-162/003-000**Male connector for rail-mount terminal blocks; 1.2 x 1.2 mm pins; straight; 100% protected against mismatching; Pin spacing 5 mm; 2-pole; light gray [www.wago.com/721-162/003-000](http://www.wago.com/721-162/003-000)**Nr. articol: 721-163/003-000**Male connector for rail-mount terminal blocks; 1.2 x 1.2 mm pins; straight; 100% protected against mismatching; Pin spacing 5 mm; 3-pole; light gray [www.wago.com/721-163/003-000](http://www.wago.com/721-163/003-000)**Nr. articol: 721-164/003-000**Male connector for rail-mount terminal blocks; 1.2 x 1.2 mm pins; straight; 100% protected against mismatching; Pin spacing 5 mm; 4-pole; light gray [www.wago.com/721-164/003-000](http://www.wago.com/721-164/003-000)**Nr. articol: 721-165/003-000**Male connector for rail-mount terminal blocks; 1.2 x 1.2 mm pins; straight; 100% protected against mismatching; Pin spacing 5 mm; 5-pole; light gray [www.wago.com/721-165/003-000](http://www.wago.com/721-165/003-000)**Nr. articol: 721-166/003-000**Male connector for rail-mount terminal blocks; 1.2 x 1.2 mm pins; straight; 100% protected against mismatching; Pin spacing 5 mm; 6-pole; light gray [www.wago.com/721-166/003-000](http://www.wago.com/721-166/003-000)**Nr. articol: 721-167/003-000**Male connector for rail-mount terminal blocks; 1.2 x 1.2 mm pins; straight; 100% protected against mismatching; Pin spacing 5 mm; 7-pole; light gray [www.wago.com/721-167/003-000](http://www.wago.com/721-167/003-000)**Nr. articol: 721-168/003-000**Male connector for rail-mount terminal blocks; 1.2 x 1.2 mm pins; straight; 100% protected against mismatching; Pin spacing 5 mm; 8-pole; light gray [www.wago.com/721-168/003-000](http://www.wago.com/721-168/003-000)**Nr. articol: 721-169/003-000**Male connector for rail-mount terminal blocks; 1.2 x 1.2 mm pins; straight; 100% protected against mismatching; Pin spacing 5 mm; 9-pole; light gray [www.wago.com/721-169/003-000](http://www.wago.com/721-169/003-000)**Nr. articol: 721-170/003-000**Male connector for rail-mount terminal blocks; 1.2 x 1.2 mm pins; straight; 100% protected against mismatching; Pin spacing 5 mm; 10-pole; light gray [www.wago.com/721-170/003-000](http://www.wago.com/721-170/003-000)**Nr. articol: 721-171/003-000**

Supus modificărilor.



Male connector for rail-mount terminal blocks; 1.2 x 1.2 mm pins; straight; 100% protected against mismatching; Pin spacing 5 mm; 11-pole; light gray

[www.wago.com/721-171/003-000](http://www.wago.com/721-171/003-000)



**Nr. articol: 721-172/003-000**

Male connector for rail-mount terminal blocks; 1.2 x 1.2 mm pins; straight; 100% protected against mismatching; Pin spacing 5 mm; 12-pole; light gray

[www.wago.com/721-172/003-000](http://www.wago.com/721-172/003-000)



**Nr. articol: 721-173/003-000**

Male connector for rail-mount terminal blocks; 1.2 x 1.2 mm pins; straight; 100% protected against mismatching; Pin spacing 5 mm; 13-pole; light gray

[www.wago.com/721-173/003-000](http://www.wago.com/721-173/003-000)



**Nr. articol: 721-174/003-000**

Male connector for rail-mount terminal blocks; 1.2 x 1.2 mm pins; straight; 100% protected against mismatching; Pin spacing 5 mm; 14-pole; light gray

[www.wago.com/721-174/003-000](http://www.wago.com/721-174/003-000)



**Nr. articol: 721-175/003-000**

Male connector for rail-mount terminal blocks; 1.2 x 1.2 mm pins; straight; 100% protected against mismatching; Pin spacing 5 mm; 15-pole; light gray

[www.wago.com/721-175/003-000](http://www.wago.com/721-175/003-000)



**Nr. articol: 721-176/003-000**

Male connector for rail-mount terminal blocks; 1.2 x 1.2 mm pins; straight; 100% protected against mismatching; Pin spacing 5 mm; 16-pole; light gray

[www.wago.com/721-176/003-000](http://www.wago.com/721-176/003-000)



**Nr. articol: 721-180/003-000**

Male connector for rail-mount terminal blocks; 1.2 x 1.2 mm pins; straight; 100% protected against mismatching; Pin spacing 5 mm; 20-pole; light gray

[www.wago.com/721-180/003-000](http://www.wago.com/721-180/003-000)

#### Carrier rail



**Nr. articol: 210-112**

Steel carrier rail; 35 x 7.5 mm; 1 mm thick; 2 m long; slotted; according to EN 60715; "Hole width 25 mm

[www.wago.com/210-112](http://www.wago.com/210-112)

**Nr. articol: 210-113**

Steel carrier rail; 35 x 7.5 mm; 1 mm thick; 2 m long; unslotted; according to EN 60715

[www.wago.com/210-113](http://www.wago.com/210-113)

**Nr. articol: 210-114**

Steel carrier rail; 35 x 15 mm; 1.5 mm thick; 2 m long; unslotted; similar to EN 60715

[www.wago.com/210-114](http://www.wago.com/210-114)

**Nr. articol: 210-115**

Steel carrier rail; 35 x 7.5 mm; 1 mm thick; 2 m long; slotted; according to EN 60715; "Hole width 18 mm

[www.wago.com/210-115](http://www.wago.com/210-115)

**Nr. articol: 210-118**

Steel carrier rail; 35 x 15 mm; 2.3 mm thick; 2 m long; unslotted; according to EN 60715

[www.wago.com/210-118](http://www.wago.com/210-118)

**Nr. articol: 210-196**

Aluminum carrier rail; 35 x 8.2 mm; 1.6 mm thick; 2 m long; unslotted; similar to EN 60715; silver-colored

[www.wago.com/210-196](http://www.wago.com/210-196)



**Nr. articol: 210-197**

Steel carrier rail; 35 x 15 mm; 1.5 mm thick; 2 m long; slotted; similar to EN 60715















[www.wago.com/210-197](http://www.wago.com/210-197)

**Nr. articol: 210-198**

Copper carrier rail; 35 x 15 mm; 2.3 mm thick; 2 m long; unslotted; according to EN 60715; copper-

[www.wago.com/210-198](http://www.wago.com/210-198)

Supus modificărilor.













	colored	
	<b>Nr. articol: 210-504</b> Steel carrier rail; 35 x 7.5 mm; 1 mm thick; 2 m long; slotted; galvanized; according to EN 60715	<a href="http://www.wago.com/210-504">www.wago.com/210-504</a>
	<b>Nr. articol: 210-505</b> Steel carrier rail; 35 x 7.5 mm; 1 mm thick; 2 m long; unslotted; galvanized; according to EN 60715	<a href="http://www.wago.com/210-505">www.wago.com/210-505</a>
	<b>Nr. articol: 210-506</b> Steel carrier rail; 35 x 15 mm; 1.5 mm thick; 2 m long; unslotted; galvanized; similar to EN 60715	<a href="http://www.wago.com/210-506">www.wago.com/210-506</a>
	<b>Nr. articol: 210-508</b> Steel carrier rail; 35 x 15 mm; 1.5 mm thick; 2 m long; slotted; galvanized; similar to EN 60715	<a href="http://www.wago.com/210-508">www.wago.com/210-508</a>
<b>Female plug</b>		
	<b>Nr. articol: 232-132/005-000</b> Female connector for rail-mount terminal blocks; 0.6 x 1 mm pins; straight; Pin spacing 5 mm; 2-pole; gray	<a href="http://www.wago.com/232-132/005-000">www.wago.com/232-132/005-000</a>
	<b>Nr. articol: 232-132/005-000/039-000</b> Female connector for rail-mount terminal blocks; 0.6 x 1 mm pins; straight; Locking lever; Pin spacing 5 mm; 2-pole; gray	<a href="http://www.wago.com/232-132/005-000/039-000">www.wago.com/232-132/005-000/039-000</a>
	<b>Nr. articol: 232-133/005-000</b> Female connector for rail-mount terminal blocks; 0.6 x 1 mm pins; straight; Pin spacing 5 mm; 3-pole; gray	<a href="http://www.wago.com/232-133/005-000">www.wago.com/232-133/005-000</a>
	<b>Nr. articol: 232-133/005-000/039-000</b> Female connector for rail-mount terminal blocks; 0.6 x 1 mm pins; straight; Locking lever; Pin spacing 5 mm; 3-pole; gray	<a href="http://www.wago.com/232-133/005-000/039-000">www.wago.com/232-133/005-000/039-000</a>
	<b>Nr. articol: 232-134/005-000</b> Female connector for rail-mount terminal blocks; 0.6 x 1 mm pins; straight; Pin spacing 5 mm; 4-pole; gray	<a href="http://www.wago.com/232-134/005-000">www.wago.com/232-134/005-000</a>
	<b>Nr. articol: 232-134/005-000/039-000</b> Female connector for rail-mount terminal blocks; 0.6 x 1 mm pins; straight; Locking lever; Pin spacing 5 mm; 4-pole; gray	<a href="http://www.wago.com/232-134/005-000/039-000">www.wago.com/232-134/005-000/039-000</a>
	<b>Nr. articol: 232-135/005-000</b> Female connector for rail-mount terminal blocks; 0.6 x 1 mm pins; straight; Pin spacing 5 mm; 5-pole; gray	<a href="http://www.wago.com/232-135/005-000">www.wago.com/232-135/005-000</a>
	<b>Nr. articol: 232-135/005-000/039-000</b> Female connector for rail-mount terminal blocks; 0.6 x 1 mm pins; straight; Locking lever; Pin spacing 5 mm; 5-pole; gray	<a href="http://www.wago.com/232-135/005-000/039-000">www.wago.com/232-135/005-000/039-000</a>
	<b>Nr. articol: 232-136/005-000</b> Female connector for rail-mount terminal blocks; 0.6 x 1 mm pins; straight; Pin spacing 5 mm; 6-pole; gray	<a href="http://www.wago.com/232-136/005-000">www.wago.com/232-136/005-000</a>

Supus modificărilor.



**Nr. articol: 232-136/005-000/039-000**Female connector for rail-mount terminal blocks; 0.6 x 1 mm pins; straight; Locking lever; Pin spacing 5 mm; 6-pole; gray [www.wago.com/232-136/005-000/039-000](http://www.wago.com/232-136/005-000/039-000)**Nr. articol: 232-137/005-000**Female connector for rail-mount terminal blocks; 0.6 x 1 mm pins; straight; Pin spacing 5 mm; 7-pole; gray [www.wago.com/232-137/005-000](http://www.wago.com/232-137/005-000)**Nr. articol: 232-137/005-000/039-000**Female connector for rail-mount terminal blocks; 0.6 x 1 mm pins; straight; Locking lever; Pin spacing 5 mm; 7-pole; gray [www.wago.com/232-137/005-000/039-000](http://www.wago.com/232-137/005-000/039-000)**Nr. articol: 232-138/005-000**Female connector for rail-mount terminal blocks; 0.6 x 1 mm pins; straight; Pin spacing 5 mm; 8-pole; gray [www.wago.com/232-138/005-000](http://www.wago.com/232-138/005-000)**Nr. articol: 232-138/005-000/039-000**Female connector for rail-mount terminal blocks; 0.6 x 1 mm pins; straight; Locking lever; Pin spacing 5 mm; 8-pole; gray [www.wago.com/232-138/005-000/039-000](http://www.wago.com/232-138/005-000/039-000)**Nr. articol: 232-139/005-000**Female connector for rail-mount terminal blocks; 0.6 x 1 mm pins; straight; Pin spacing 5 mm; 9-pole; gray [www.wago.com/232-139/005-000](http://www.wago.com/232-139/005-000)**Nr. articol: 232-139/005-000/039-000**Female connector for rail-mount terminal blocks; 0.6 x 1 mm pins; straight; Locking lever; Pin spacing 5 mm; 9-pole; gray [www.wago.com/232-139/005-000/039-000](http://www.wago.com/232-139/005-000/039-000)**Nr. articol: 232-140/005-000**Female connector for rail-mount terminal blocks; 0.6 x 1 mm pins; straight; Pin spacing 5 mm; 10-pole; gray [www.wago.com/232-140/005-000](http://www.wago.com/232-140/005-000)**Nr. articol: 232-140/005-000/039-000**Female connector for rail-mount terminal blocks; 0.6 x 1 mm pins; straight; Locking lever; Pin spacing 5 mm; 10-pole; gray [www.wago.com/232-140/005-000/039-000](http://www.wago.com/232-140/005-000/039-000)**Nr. articol: 232-142/005-000**Female connector for rail-mount terminal blocks; 0.6 x 1 mm pins; straight; Pin spacing 5 mm; 12-pole; gray [www.wago.com/232-142/005-000](http://www.wago.com/232-142/005-000)**Nr. articol: 232-142/005-000/039-000**Female connector for rail-mount terminal blocks; 0.6 x 1 mm pins; straight; Locking lever; Pin spacing 5 mm; 12-pole; gray [www.wago.com/232-142/005-000/039-000](http://www.wago.com/232-142/005-000/039-000)**Nr. articol: 232-146/005-000**Female connector for rail-mount terminal blocks; 0.6 x 1 mm pins; straight; Pin spacing 5 mm; 16-pole; gray [www.wago.com/232-146/005-000](http://www.wago.com/232-146/005-000)**Nr. articol: 232-146/005-000/039-000**Female connector for rail-mount terminal blocks; 0.6 x 1 mm pins; straight; Locking lever; Pin spacing 5 mm; 16-pole; gray [www.wago.com/232-146/005-000/039-000](http://www.wago.com/232-146/005-000/039-000)**Nr. articol: 232-147/005-000/039-000**

Supus modificărilor.













	Female connector for rail-mount terminal blocks; 0.6 x 1 mm pins; straight; Locking lever; Pin spacing 5 mm; 17-pole; gray	<a href="http://www.wago.com/232-147/005-000/039-000">www.wago.com/232-147/005-000/039-000</a>
	<b>Nr. articol: 232-150/005-000</b> Female connector for rail-mount terminal blocks; 0.6 x 1 mm pins; straight; Pin spacing 5 mm; 20-pole; gray	<a href="http://www.wago.com/232-150/005-000">www.wago.com/232-150/005-000</a>
	<b>Nr. articol: 232-150/005-000/039-000</b> Female connector for rail-mount terminal blocks; 0.6 x 1 mm pins; straight; Locking lever; Pin spacing 5 mm; 20-pole; gray	<a href="http://www.wago.com/232-150/005-000/039-000">www.wago.com/232-150/005-000/039-000</a>
	<b>Nr. articol: 232-232/005-000</b> Female connector for rail-mount terminal blocks; 0.6 x 1 mm pins; angled; Pin spacing 5 mm; 2-pole; gray	<a href="http://www.wago.com/232-232/005-000">www.wago.com/232-232/005-000</a>
	<b>Nr. articol: 232-232/005-000/039-000</b> Female connector for rail-mount terminal blocks; 0.6 x 1 mm pins; angled; Locking lever; Pin spacing 5 mm; 2-pole; gray	<a href="http://www.wago.com/232-232/005-000/039-000">www.wago.com/232-232/005-000/039-000</a>
	<b>Nr. articol: 232-233/005-000</b> Female connector for rail-mount terminal blocks; 0.6 x 1 mm pins; angled; Pin spacing 5 mm; 3-pole; gray	<a href="http://www.wago.com/232-233/005-000">www.wago.com/232-233/005-000</a>
	<b>Nr. articol: 232-233/005-000/039-000</b> Female connector for rail-mount terminal blocks; 0.6 x 1 mm pins; angled; Locking lever; Pin spacing 5 mm; 3-pole; gray	<a href="http://www.wago.com/232-233/005-000/039-000">www.wago.com/232-233/005-000/039-000</a>
	<b>Nr. articol: 232-234/005-000</b> Female connector for rail-mount terminal blocks; 0.6 x 1 mm pins; angled; Pin spacing 5 mm; 4-pole; gray	<a href="http://www.wago.com/232-234/005-000">www.wago.com/232-234/005-000</a>
	<b>Nr. articol: 232-234/005-000/039-000</b> Female connector for rail-mount terminal blocks; 0.6 x 1 mm pins; angled; Locking lever; Pin spacing 5 mm; 4-pole; gray	<a href="http://www.wago.com/232-234/005-000/039-000">www.wago.com/232-234/005-000/039-000</a>
	<b>Nr. articol: 232-235/005-000</b> Female connector for rail-mount terminal blocks; 0.6 x 1 mm pins; angled; Pin spacing 5 mm; 5-pole; gray	<a href="http://www.wago.com/232-235/005-000">www.wago.com/232-235/005-000</a>
	<b>Nr. articol: 232-235/005-000/039-000</b> Female connector for rail-mount terminal blocks; 0.6 x 1 mm pins; angled; Locking lever; Pin spacing 5 mm; 5-pole; gray	<a href="http://www.wago.com/232-235/005-000/039-000">www.wago.com/232-235/005-000/039-000</a>
	<b>Nr. articol: 232-236/005-000</b> Female connector for rail-mount terminal blocks; 0.6 x 1 mm pins; angled; Pin spacing 5 mm; 6-pole; gray	<a href="http://www.wago.com/232-236/005-000">www.wago.com/232-236/005-000</a>
	<b>Nr. articol: 232-236/005-000/039-000</b> Female connector for rail-mount terminal blocks; 0.6 x 1 mm pins; angled; Locking lever; Pin spacing 5 mm; 6-pole; gray	<a href="http://www.wago.com/232-236/005-000/039-000">www.wago.com/232-236/005-000/039-000</a>

**Nr. articol: 232-237/005-000**













Supus modificărilor.

WAGO Kontakttechnik GmbH & Co. KG  
/Representative Office Romania  
Sos. Pipera-Tunari nr. 1/1  
building 1, 2nd floor | 077190 Voluntari, Ilfov  
Tel.: +40-(0)31 421 85 68 | Email: info-RO@wago.com

Aveți întrebări despre produsele noastre?  
Vă stăm la dispoziție pentru preluarea apelului la +40 (0) 31 421 85 68.

	Female connector for rail-mount terminal blocks; 0.6 x 1 mm pins; angled; Pin spacing 5 mm; 7-pole; gray	<a href="http://www.wago.com/232-237/005-000">www.wago.com/232-237/005-000</a>
	<b>Nr. articol: 232-238/005-000</b> Female connector for rail-mount terminal blocks; 0.6 x 1 mm pins; angled; Pin spacing 5 mm; 8-pole; gray	<a href="http://www.wago.com/232-238/005-000">www.wago.com/232-238/005-000</a>
	<b>Nr. articol: 232-239/005-000</b> Female connector for rail-mount terminal blocks; 0.6 x 1 mm pins; angled; Pin spacing 5 mm; 9-pole; gray	<a href="http://www.wago.com/232-239/005-000">www.wago.com/232-239/005-000</a>
	<b>Nr. articol: 232-240/005-000</b> Female connector for rail-mount terminal blocks; 0.6 x 1 mm pins; angled; Pin spacing 5 mm; 10-pole; gray	<a href="http://www.wago.com/232-240/005-000">www.wago.com/232-240/005-000</a>
	<b>Nr. articol: 232-240/005-000/039-000</b> Female connector for rail-mount terminal blocks; 0.6 x 1 mm pins; angled; Locking lever; Pin spacing 5 mm; 10-pole; gray	<a href="http://www.wago.com/232-240/005-000/039-000">www.wago.com/232-240/005-000/039-000</a>
	<b>Nr. articol: 232-242/005-000</b> Female connector for rail-mount terminal blocks; 0.6 x 1 mm pins; angled; Pin spacing 5 mm; 12-pole; gray	<a href="http://www.wago.com/232-242/005-000">www.wago.com/232-242/005-000</a>
	<b>Nr. articol: 232-242/005-000/039-000</b> Female connector for rail-mount terminal blocks; 0.6 x 1 mm pins; angled; Locking lever; Pin spacing 5 mm; 12-pole; gray	<a href="http://www.wago.com/232-242/005-000/039-000">www.wago.com/232-242/005-000/039-000</a>
	<b>Nr. articol: 232-246/005-000</b> Female connector for rail-mount terminal blocks; 0.6 x 1 mm pins; angled; Pin spacing 5 mm; 16-pole; gray	<a href="http://www.wago.com/232-246/005-000">www.wago.com/232-246/005-000</a>
	<b>Nr. articol: 232-246/005-000/039-000</b> Female connector for rail-mount terminal blocks; 0.6 x 1 mm pins; angled; Locking lever; Pin spacing 5 mm; 16-pole; gray	<a href="http://www.wago.com/232-246/005-000/039-000">www.wago.com/232-246/005-000/039-000</a>
	<b>Nr. articol: 232-250/005-000</b> Female connector for rail-mount terminal blocks; 0.6 x 1 mm pins; angled; Pin spacing 5 mm; 20-pole; gray	<a href="http://www.wago.com/232-250/005-000">www.wago.com/232-250/005-000</a>
	<b>Nr. articol: 232-250/005-000/039-000</b> Female connector for rail-mount terminal blocks; 0.6 x 1 mm pins; angled; Locking lever; Pin spacing 5 mm; 20-pole; gray	<a href="http://www.wago.com/232-250/005-000/039-000">www.wago.com/232-250/005-000/039-000</a>
	<b>Nr. articol: 232-732/005-000</b> THT female header; 0.6 x 1.0 mm solder pin; gray	<a href="http://www.wago.com/232-732/005-000">www.wago.com/232-732/005-000</a>
	<b>Nr. articol: 232-733/005-000</b> THT female header; 0.6 x 1.0 mm solder pin; gray	<a href="http://www.wago.com/232-733/005-000">www.wago.com/232-733/005-000</a>

Supus modificărilor.

	<b>Nr. articol: 232-734/005-000</b> THT female header; 0.6 x 1.0 mm solder pin; gray	<a href="http://www.wago.com/232-734/005-000">www.wago.com/232-734/005-000</a>
	<b>Nr. articol: 232-734/005-000/039-000</b> THT female header; 0.6 x 1.0 mm solder pin; gray	<a href="http://www.wago.com/232-734/005-000/039-000">www.wago.com/232-734/005-000/039-000</a>
	<b>Nr. articol: 232-735/005-000</b> THT female header; 0.6 x 1.0 mm solder pin; gray	<a href="http://www.wago.com/232-735/005-000">www.wago.com/232-735/005-000</a>
	<b>Nr. articol: 232-735/005-000/039-000</b> THT female header; 0.6 x 1.0 mm solder pin; gray	<a href="http://www.wago.com/232-735/005-000/039-000">www.wago.com/232-735/005-000/039-000</a>
	<b>Nr. articol: 232-736/005-000</b> THT female header; 0.6 x 1.0 mm solder pin; gray	<a href="http://www.wago.com/232-736/005-000">www.wago.com/232-736/005-000</a>
	<b>Nr. articol: 232-736/005-000/039-000</b> THT female header; 0.6 x 1.0 mm solder pin; gray	<a href="http://www.wago.com/232-736/005-000/039-000">www.wago.com/232-736/005-000/039-000</a>
	<b>Nr. articol: 232-738/005-000</b> THT female header; 0.6 x 1.0 mm solder pin; gray	<a href="http://www.wago.com/232-738/005-000">www.wago.com/232-738/005-000</a>
	<b>Nr. articol: 232-740/005-000</b> THT female header; 0.6 x 1.0 mm solder pin; gray	<a href="http://www.wago.com/232-740/005-000">www.wago.com/232-740/005-000</a>
	<b>Nr. articol: 232-742/005-000</b> THT female header; 0.6 x 1.0 mm solder pin; gray	<a href="http://www.wago.com/232-742/005-000">www.wago.com/232-742/005-000</a>
	<b>Nr. articol: 232-832/005-000</b> THT female header; 0.6 x 1.0 mm solder pin; angled; Pin spacing 7.5 mm; 2-pole; gray	<a href="http://www.wago.com/232-832/005-000">www.wago.com/232-832/005-000</a>
	<b>Nr. articol: 232-833/005-000</b> THT female header; 0.6 x 1.0 mm solder pin; angled; Pin spacing 7.5 mm; 3-pole; gray	<a href="http://www.wago.com/232-833/005-000">www.wago.com/232-833/005-000</a>
	<b>Nr. articol: 232-834/005-000</b> THT female header; 0.6 x 1.0 mm solder pin; angled; Pin spacing 7.5 mm; 4-pole; gray	<a href="http://www.wago.com/232-834/005-000">www.wago.com/232-834/005-000</a>
	<b>Nr. articol: 232-836/005-000</b> THT female header; 0.6 x 1.0 mm solder pin; angled; Pin spacing 7.5 mm; 6-pole; gray	<a href="http://www.wago.com/232-836/005-000">www.wago.com/232-836/005-000</a>

Supus modificărilor.

**Nr. articol: 232-836/005-000/039-000**

THT female header; 0.6 x 1.0 mm solder pin; angled; Locking lever; Pin spacing 7.5 mm; 6-pole; gray

[www.wago.com/232-836/005-000/039-000](http://www.wago.com/232-836/005-000/039-000)**Nr. articol: 232-840/005-000**

THT female header; 0.6 x 1.0 mm solder pin; angled; Pin spacing 7.5 mm; 10-pole; gray

[www.wago.com/232-840/005-000](http://www.wago.com/232-840/005-000)**Nr. articol: 232-842/005-000**

THT female header; 0.6 x 1.0 mm solder pin; angled; Pin spacing 7.5 mm; 12-pole; gray

[www.wago.com/232-842/005-000](http://www.wago.com/232-842/005-000)**Nr. articol: 722-132/005-000**

Female connector for rail-mount terminal blocks; 0.6 x 1 mm pins; straight; 100% protected against mismatching; Pin spacing 5 mm; 2-pole; light gray

[www.wago.com/722-132/005-000](http://www.wago.com/722-132/005-000)**Nr. articol: 722-132/005-000/039-000**

Female connector for rail-mount terminal blocks; 0.6 x 1 mm pins; straight; 100% protected against mismatching; Locking lever; Pin spacing 5 mm; 2-pole; light gray

[www.wago.com/722-132/005-000/039-000](http://www.wago.com/722-132/005-000/039-000)**Nr. articol: 722-133/005-000**

Female connector for rail-mount terminal blocks; 0.6 x 1 mm pins; straight; 100% protected against mismatching; Pin spacing 5 mm; 3-pole; light gray

[www.wago.com/722-133/005-000](http://www.wago.com/722-133/005-000)**Nr. articol: 722-133/005-000/039-000**

Female connector for rail-mount terminal blocks; 0.6 x 1 mm pins; straight; 100% protected against mismatching; Locking lever; Pin spacing 5 mm; 3-pole; light gray

[www.wago.com/722-133/005-000/039-000](http://www.wago.com/722-133/005-000/039-000)**Nr. articol: 722-134/005-000**

Female connector for rail-mount terminal blocks; 0.6 x 1 mm pins; straight; 100% protected against mismatching; Pin spacing 5 mm; 4-pole; light gray

[www.wago.com/722-134/005-000](http://www.wago.com/722-134/005-000)**Nr. articol: 722-134/005-000/039-000**

Female connector for rail-mount terminal blocks; 0.6 x 1 mm pins; straight; 100% protected against mismatching; Locking lever; Pin spacing 5 mm; 4-pole; light gray

[www.wago.com/722-134/005-000/039-000](http://www.wago.com/722-134/005-000/039-000)**Nr. articol: 722-135/005-000**

Female connector for rail-mount terminal blocks; 0.6 x 1 mm pins; straight; 100% protected against mismatching; Pin spacing 5 mm; 5-pole; light gray

[www.wago.com/722-135/005-000](http://www.wago.com/722-135/005-000)**Nr. articol: 722-135/005-000/039-000**

Female connector for rail-mount terminal blocks; 0.6 x 1 mm pins; straight; 100% protected against mismatching; Locking lever; Pin spacing 5 mm; 5-pole; light gray

[www.wago.com/722-135/005-000/039-000](http://www.wago.com/722-135/005-000/039-000)**Nr. articol: 722-136/005-000**













Female connector for rail-mount terminal blocks; 0.6 x 1 mm pins; straight; 100% protected against mismatching; Pin spacing 5 mm; 6-pole; light gray

[www.wago.com/722-136/005-000](http://www.wago.com/722-136/005-000)**Nr. articol: 722-136/005-000/039-000**

Female connector for rail-mount terminal blocks; 0.6 x 1 mm pins; straight; 100% protected against mismatching; Locking lever; Pin spacing 5 mm; 6-pole; light gray

[www.wago.com/722-136/005-000/039-000](http://www.wago.com/722-136/005-000/039-000)**Nr. articol: 722-137/005-000**

Supus modificărilor.

	Female connector for rail-mount terminal blocks; 0.6 x 1 mm pins; straight; 100% protected against mismatching; Pin spacing 5 mm; 7-pole; light gray	<a href="http://www.wago.com/722-137/005-000">www.wago.com/722-137/005-000</a>
	<b>Nr. articol: 722-137/005-000/039-000</b> Female connector for rail-mount terminal blocks; 0.6 x 1 mm pins; straight; 100% protected against mismatching; Locking lever; Pin spacing 5 mm; 7-pole; light gray	<a href="http://www.wago.com/722-137/005-000/039-000">www.wago.com/722-137/005-000/039-000</a>
	<b>Nr. articol: 722-138/005-000</b> Female connector for rail-mount terminal blocks; 0.6 x 1 mm pins; straight; 100% protected against mismatching; Pin spacing 5 mm; 8-pole; light gray	<a href="http://www.wago.com/722-138/005-000">www.wago.com/722-138/005-000</a>
	<b>Nr. articol: 722-138/005-000/039-000</b> Female connector for rail-mount terminal blocks; 0.6 x 1 mm pins; straight; 100% protected against mismatching; Locking lever; Pin spacing 5 mm; 8-pole; light gray	<a href="http://www.wago.com/722-138/005-000/039-000">www.wago.com/722-138/005-000/039-000</a>
	<b>Nr. articol: 722-139/005-000</b> Female connector for rail-mount terminal blocks; 0.6 x 1 mm pins; straight; 100% protected against mismatching; Pin spacing 5 mm; 9-pole; light gray	<a href="http://www.wago.com/722-139/005-000">www.wago.com/722-139/005-000</a>
	<b>Nr. articol: 722-139/005-000/039-000</b> Female connector for rail-mount terminal blocks; 0.6 x 1 mm pins; straight; 100% protected against mismatching; Locking lever; Pin spacing 5 mm; 9-pole; light gray	<a href="http://www.wago.com/722-139/005-000/039-000">www.wago.com/722-139/005-000/039-000</a>
	<b>Nr. articol: 722-140/005-000</b> Female connector for rail-mount terminal blocks; 0.6 x 1 mm pins; straight; 100% protected against mismatching; Pin spacing 5 mm; 10-pole; light gray	<a href="http://www.wago.com/722-140/005-000">www.wago.com/722-140/005-000</a>
	<b>Nr. articol: 722-140/005-000/039-000</b> Female connector for rail-mount terminal blocks; 0.6 x 1 mm pins; straight; 100% protected against mismatching; Locking lever; Pin spacing 5 mm; 10-pole; light gray	<a href="http://www.wago.com/722-140/005-000/039-000">www.wago.com/722-140/005-000/039-000</a>
	<b>Nr. articol: 722-141/005-000</b> Female connector for rail-mount terminal blocks; 0.6 x 1 mm pins; straight; 100% protected against mismatching; Pin spacing 5 mm; 11-pole; light gray	<a href="http://www.wago.com/722-141/005-000">www.wago.com/722-141/005-000</a>
	<b>Nr. articol: 722-142/005-000</b> Female connector for rail-mount terminal blocks; 0.6 x 1 mm pins; straight; 100% protected against mismatching; Pin spacing 5 mm; 12-pole; light gray	<a href="http://www.wago.com/722-142/005-000">www.wago.com/722-142/005-000</a>
	<b>Nr. articol: 722-142/005-007/039-000</b> Female connector for rail-mount terminal blocks; gray	<a href="http://www.wago.com/722-142/005-007/039-000">www.wago.com/722-142/005-007/039-000</a>
	<b>Nr. articol: 722-143/005-000</b> Female connector for rail-mount terminal blocks; 0.6 x 1 mm pins; straight; 100% protected against mismatching; Pin spacing 5 mm; 13-pole; light gray	<a href="http://www.wago.com/722-143/005-000">www.wago.com/722-143/005-000</a>
	<b>Nr. articol: 722-144/005-000</b> Female connector for rail-mount terminal blocks; 0.6 x 1 mm pins; straight; 100% protected against mismatching; Pin spacing 5 mm; 14-pole; light gray	<a href="http://www.wago.com/722-144/005-000">www.wago.com/722-144/005-000</a>

**Nr. articol: 722-144/005-000/039-000**

Supus modificărilor.

WAGO Kontakttechnik GmbH & Co. KG  
/Representative Office Romania  
Sos. Pipera-Tunari nr. 1/1  
building 1, 2nd floor | 077190 Voluntari, Ilfov  
Tel.: +40-(0)31 421 85 68 | Email: info-RO@wago.com

Aveți întrebări despre produsele noastre?  
Vă stăm la dispoziție pentru preluarea apelului la +40 (0) 31 421 85 68.



Female connector for rail-mount terminal blocks; 0.6 x 1 mm pins; straight; 100% protected against mismatching; Locking lever; Pin spacing 5 mm; 14-pole; light gray

[www.wago.com/722-144/005-000/039-000](http://www.wago.com/722-144/005-000/039-000)



**Nr. articol: 722-145/005-000**

Female connector for rail-mount terminal blocks; 0.6 x 1 mm pins; straight; 100% protected against mismatching; Pin spacing 5 mm; 15-pole; light gray

[www.wago.com/722-145/005-000](http://www.wago.com/722-145/005-000)



**Nr. articol: 722-146/005-000**

Female connector for rail-mount terminal blocks; 0.6 x 1 mm pins; straight; 100% protected against mismatching; Pin spacing 5 mm; 16-pole; light gray

[www.wago.com/722-146/005-000](http://www.wago.com/722-146/005-000)



**Nr. articol: 722-146/005-000/039-000**

Female connector for rail-mount terminal blocks; 0.6 x 1 mm pins; straight; 100% protected against mismatching; Locking lever; Pin spacing 5 mm; 16-pole; light gray

[www.wago.com/722-146/005-000/039-000](http://www.wago.com/722-146/005-000/039-000)



**Nr. articol: 722-150/005-000**

Female connector for rail-mount terminal blocks; 0.6 x 1 mm pins; straight; 100% protected against mismatching; Pin spacing 5 mm; 20-pole; light gray

[www.wago.com/722-150/005-000](http://www.wago.com/722-150/005-000)



**Nr. articol: 722-150/005-000/039-000**

Female connector for rail-mount terminal blocks; 0.6 x 1 mm pins; straight; 100% protected against mismatching; Locking lever; Pin spacing 5 mm; 20-pole; light gray

[www.wago.com/722-150/005-000/039-000](http://www.wago.com/722-150/005-000/039-000)



**Nr. articol: 722-232/005-000**

Female connector for rail-mount terminal blocks; 0.6 x 1 mm pins; angled; 100% protected against mismatching; Pin spacing 5 mm; 2-pole; light gray

[www.wago.com/722-232/005-000](http://www.wago.com/722-232/005-000)



**Nr. articol: 722-232/005-000/039-000**

Female connector for rail-mount terminal blocks; 0.6 x 1 mm pins; angled; 100% protected against mismatching; Locking lever; Pin spacing 5 mm; 2-pole; light gray

[www.wago.com/722-232/005-000/039-000](http://www.wago.com/722-232/005-000/039-000)



**Nr. articol: 722-233/005-000**

Female connector for rail-mount terminal blocks; 0.6 x 1 mm pins; angled; 100% protected against mismatching; Pin spacing 5 mm; 3-pole; light gray

[www.wago.com/722-233/005-000](http://www.wago.com/722-233/005-000)



**Nr. articol: 722-233/005-000/039-000**

Female connector for rail-mount terminal blocks; 0.6 x 1 mm pins; angled; 100% protected against mismatching; Locking lever; Pin spacing 5 mm; 3-pole; light gray

[www.wago.com/722-233/005-000/039-000](http://www.wago.com/722-233/005-000/039-000)



**Nr. articol: 722-234/005-000**

Female connector for rail-mount terminal blocks; 0.6 x 1 mm pins; angled; 100% protected against mismatching; Pin spacing 5 mm; 4-pole; light gray

[www.wago.com/722-234/005-000](http://www.wago.com/722-234/005-000)



**Nr. articol: 722-234/005-000/039-000**

Female connector for rail-mount terminal blocks; 0.6 x 1 mm pins; angled; 100% protected against mismatching; Locking lever; Pin spacing 5 mm; 4-pole; light gray

[www.wago.com/722-234/005-000/039-000](http://www.wago.com/722-234/005-000/039-000)



**Nr. articol: 722-235/005-000**

Female connector for rail-mount terminal blocks; 0.6 x 1 mm pins; angled; 100% protected against mismatching; Pin spacing 5 mm; 5-pole; light gray













[www.wago.com/722-235/005-000](http://www.wago.com/722-235/005-000)

**Nr. articol: 722-235/005-000/039-000**

Supus modificărilor.

WAGO Kontakttechnik GmbH & Co. KG  
/Representative Office Romania  
Sos. Pipera-Tunari nr. 1/1  
building 1, 2nd floor | 077190 Voluntari, Ilfov  
Tel.: +40-(0)31 421 85 68 | Email: info-RO@wago.com

Aveți întrebări despre produsele noastre?  
Vă stăm la dispoziție pentru preluarea apelului la +40 (0) 31 421 85 68.

	Female connector for rail-mount terminal blocks; 0.6 x 1 mm pins; angled; 100% protected against mismatching; Locking lever; Pin spacing 5 mm; 5-pole; light gray	<a href="http://www.wago.com/722-235/005-000/039-000">www.wago.com/722-235/005-000/039-000</a>
	<b>Nr. articol: 722-236/005-000</b> Female connector for rail-mount terminal blocks; 0.6 x 1 mm pins; angled; 100% protected against mismatching; Pin spacing 5 mm; 6-pole; light gray	<a href="http://www.wago.com/722-236/005-000">www.wago.com/722-236/005-000</a>
	<b>Nr. articol: 722-236/005-000/039-000</b> Female connector for rail-mount terminal blocks; 0.6 x 1 mm pins; angled; 100% protected against mismatching; Locking lever; Pin spacing 5 mm; 6-pole; light gray	<a href="http://www.wago.com/722-236/005-000/039-000">www.wago.com/722-236/005-000/039-000</a>
	<b>Nr. articol: 722-237/005-000</b> Female connector for rail-mount terminal blocks; 0.6 x 1 mm pins; angled; 100% protected against mismatching; Pin spacing 5 mm; 7-pole; light gray	<a href="http://www.wago.com/722-237/005-000">www.wago.com/722-237/005-000</a>
	<b>Nr. articol: 722-237/005-000/039-000</b> Female connector for rail-mount terminal blocks; 0.6 x 1 mm pins; angled; 100% protected against mismatching; Locking lever; Pin spacing 5 mm; 7-pole; light gray	<a href="http://www.wago.com/722-237/005-000/039-000">www.wago.com/722-237/005-000/039-000</a>
	<b>Nr. articol: 722-238/005-000</b> Female connector for rail-mount terminal blocks; 0.6 x 1 mm pins; angled; 100% protected against mismatching; Pin spacing 5 mm; 8-pole; light gray	<a href="http://www.wago.com/722-238/005-000">www.wago.com/722-238/005-000</a>
	<b>Nr. articol: 722-239/005-000</b> Female connector for rail-mount terminal blocks; 0.6 x 1 mm pins; angled; 100% protected against mismatching; Pin spacing 5 mm; 9-pole; light gray	<a href="http://www.wago.com/722-239/005-000">www.wago.com/722-239/005-000</a>
	<b>Nr. articol: 722-239/005-000/039-000</b> Female connector for rail-mount terminal blocks; 0.6 x 1 mm pins; angled; 100% protected against mismatching; Locking lever; Pin spacing 5 mm; 9-pole; light gray	<a href="http://www.wago.com/722-239/005-000/039-000">www.wago.com/722-239/005-000/039-000</a>
	<b>Nr. articol: 722-240/005-000</b> Female connector for rail-mount terminal blocks; 0.6 x 1 mm pins; angled; 100% protected against mismatching; Pin spacing 5 mm; 10-pole; light gray	<a href="http://www.wago.com/722-240/005-000">www.wago.com/722-240/005-000</a>
	<b>Nr. articol: 722-240/005-000/039-000</b> Female connector for rail-mount terminal blocks; 0.6 x 1 mm pins; angled; 100% protected against mismatching; Locking lever; Pin spacing 5 mm; 10-pole; light gray	<a href="http://www.wago.com/722-240/005-000/039-000">www.wago.com/722-240/005-000/039-000</a>
	<b>Nr. articol: 722-241/005-000</b> Female connector for rail-mount terminal blocks; 0.6 x 1 mm pins; angled; 100% protected against mismatching; Pin spacing 5 mm; 11-pole; light gray	<a href="http://www.wago.com/722-241/005-000">www.wago.com/722-241/005-000</a>
	<b>Nr. articol: 722-242/005-000</b> Female connector for rail-mount terminal blocks; 0.6 x 1 mm pins; angled; 100% protected against mismatching; Pin spacing 5 mm; 12-pole; light gray	<a href="http://www.wago.com/722-242/005-000">www.wago.com/722-242/005-000</a>
	<b>Nr. articol: 722-242/005-000/039-000</b> Female connector for rail-mount terminal blocks; 0.6 x 1 mm pins; angled; 100% protected against mismatching; Locking lever; Pin spacing 5 mm; 12-pole; light gray	<a href="http://www.wago.com/722-242/005-000/039-000">www.wago.com/722-242/005-000/039-000</a>

**Nr. articol: 722-243/005-000**

Supus modificărilor.

WAGO Kontakttechnik GmbH & Co. KG  
/Representative Office Romania  
Sos. Pipera-Tunari nr. 1/1  
building 1, 2nd floor | 077190 Voluntari, Ilfov  
Tel.: +40-(0)31 421 85 68 | Email: info-RO@wago.com

Aveți întrebări despre produsele noastre?  
Vă stăm la dispoziție pentru preluarea apelului la +40 (0) 31 421 85 68.





Female connector for rail-mount terminal blocks; 0.6 x 1 mm pins; angled; 100% protected against mismatching; Pin spacing 5 mm; 13-pole; light gray

[www.wago.com/722-243/005-000](http://www.wago.com/722-243/005-000)



**Nr. articol: 722-244/005-000**

Female connector for rail-mount terminal blocks; 0.6 x 1 mm pins; angled; 100% protected against mismatching; Pin spacing 5 mm; 14-pole; light gray

[www.wago.com/722-244/005-000](http://www.wago.com/722-244/005-000)



**Nr. articol: 722-244/005-000/039-000**

Female connector for rail-mount terminal blocks; 0.6 x 1 mm pins; angled; 100% protected against mismatching; Locking lever; Pin spacing 5 mm; 14-pole; light gray

[www.wago.com/722-244/005-000/039-000](http://www.wago.com/722-244/005-000/039-000)



**Nr. articol: 722-246/005-000**

Female connector for rail-mount terminal blocks; 0.6 x 1 mm pins; angled; 100% protected against mismatching; Pin spacing 5 mm; 16-pole; light gray

[www.wago.com/722-246/005-000](http://www.wago.com/722-246/005-000)



**Nr. articol: 722-246/005-000/039-000**

Female connector for rail-mount terminal blocks; 0.6 x 1 mm pins; angled; 100% protected against mismatching; Locking lever; Pin spacing 5 mm; 16-pole; light gray

[www.wago.com/722-246/005-000/039-000](http://www.wago.com/722-246/005-000/039-000)



**Nr. articol: 722-250/005-000**

Female connector for rail-mount terminal blocks; 0.6 x 1 mm pins; angled; 100% protected against mismatching; Pin spacing 5 mm; 20-pole; light gray

[www.wago.com/722-250/005-000](http://www.wago.com/722-250/005-000)

**Marking accessories**



**Nr. articol: 2009-115**

WMB-Inline; for Smart Printer; 1500 pieces on roll; stretchable 5 - 5.2 mm; plain; snap-on type; white

[www.wago.com/2009-115](http://www.wago.com/2009-115)



**Nr. articol: 2009-115/000-002**

WMB-Inline; for Smart Printer; 1500 pieces on roll; stretchable 5 - 5.2 mm; plain; snap-on type; yellow

[www.wago.com/2009-115/000-002](http://www.wago.com/2009-115/000-002)



**Nr. articol: 2009-115/000-006**

WMB-Inline; for Smart Printer; 1500 pieces on roll; stretchable 5 - 5.2 mm; plain; snap-on type; blue

[www.wago.com/2009-115/000-006](http://www.wago.com/2009-115/000-006)



**Nr. articol: 2009-115/000-007**

WMB-Inline; for Smart Printer; 1500 pieces on roll; stretchable 5 - 5.2 mm; plain; snap-on type; gray

[www.wago.com/2009-115/000-007](http://www.wago.com/2009-115/000-007)



**Nr. articol: 2009-115/000-012**

WMB-Inline; for Smart Printer; 1500 pieces on roll; stretchable 5 - 5.2 mm; plain; snap-on type; orange

[www.wago.com/2009-115/000-012](http://www.wago.com/2009-115/000-012)



**Nr. articol: 2009-115/000-017**

WMB-Inline; for Smart Printer; 1500 pieces on roll; stretchable 5 - 5.2 mm; plain; snap-on type; light green

[www.wago.com/2009-115/000-017](http://www.wago.com/2009-115/000-017)



















**Nr. articol: 2009-115/000-023**

WMB-Inline; for Smart Printer; 1500 pieces on roll; stretchable 5 - 5.2 mm; plain; snap-on type; green

[www.wago.com/2009-115/000-023](http://www.wago.com/2009-115/000-023)















Supus modificărilor.

	<b>Nr. articol:</b> 2009-115/000-024 WMB-Inline; for Smart Printer; 1500 pieces on roll; stretchable 5 - 5.2 mm; plain; snap-on type; violet	<a href="http://www.wago.com/2009-115/000-024">www.wago.com/2009-115/000-024</a>
	<b>Nr. articol:</b> 209-128 Adaptor; gray	<a href="http://www.wago.com/209-128">www.wago.com/209-128</a>
	<b>Nr. articol:</b> 209-140 Group marker carrier; gray	<a href="http://www.wago.com/209-140">www.wago.com/209-140</a>
	<b>Nr. articol:</b> 209-141 Group marker carrier; gray	<a href="http://www.wago.com/209-141">www.wago.com/209-141</a>
	<b>Nr. articol:</b> 209-142 Group marker carrier; gray	<a href="http://www.wago.com/209-142">www.wago.com/209-142</a>
	<b>Nr. articol:</b> 209-185 Adaptor; gray	<a href="http://www.wago.com/209-185">www.wago.com/209-185</a>
	<b>Nr. articol:</b> 210-612 Marking strips; for self-marking; plain; Self-adhesive; transparent	<a href="http://www.wago.com/210-612">www.wago.com/210-612</a>
	<b>Nr. articol:</b> 249-105 Group marker carrier; gray	<a href="http://www.wago.com/249-105">www.wago.com/249-105</a>
	<b>Nr. articol:</b> 793-501 WMB marking card; as card; not stretchable; plain; snap-on type; white	<a href="http://www.wago.com/793-501">www.wago.com/793-501</a>
	<b>Nr. articol:</b> 793-501/000-002 WMB marking card; as card; not stretchable; plain; snap-on type; yellow	<a href="http://www.wago.com/793-501/000-002">www.wago.com/793-501/000-002</a>
	<b>Nr. articol:</b> 793-501/000-005 WMB marking card; as card; not stretchable; plain; snap-on type; red	<a href="http://www.wago.com/793-501/000-005">www.wago.com/793-501/000-005</a>
	<b>Nr. articol:</b> 793-501/000-006 WMB marking card; as card; not stretchable; plain; snap-on type; blue	<a href="http://www.wago.com/793-501/000-006">www.wago.com/793-501/000-006</a>
	<b>Nr. articol:</b> 793-501/000-007 WMB marking card; as card; not stretchable; plain; snap-on type; gray	<a href="http://www.wago.com/793-501/000-007">www.wago.com/793-501/000-007</a>
	<b>Nr. articol:</b> 793-501/000-012 WMB marking card; as card; not stretchable; plain; snap-on type; orange	<a href="http://www.wago.com/793-501/000-012">www.wago.com/793-501/000-012</a>
	<b>Nr. articol:</b> 793-501/000-017 WMB marking card; as card; not stretchable; plain; snap-on type; light green	<a href="http://www.wago.com/793-501/000-017">www.wago.com/793-501/000-017</a>
	<b>Nr. articol:</b> 793-501/000-023 WMB marking card; as card; not stretchable; plain; snap-on type; green	<a href="http://www.wago.com/793-501/000-023">www.wago.com/793-501/000-023</a>

Supus modificărilor.

WAGO Kontakttechnik GmbH & Co. KG  
/Representative Office Romania  
Sos. Pipera-Tunari nr. 1/1  
building 1, 2nd floor | 077190 Voluntari, Ilfov  
Tel.: +40-(0)31 421 85 68 | Email: info-RO@wago.com

















Aveți întrebări despre produsele noastre?  
Vă stăm la dispoziție pentru preluarea apelului la +40 (0) 31 421 85 68.

	<b>Nr. articol: 793-501/000-024</b> WMB marking card; as card; not stretchable; plain; snap-on type; violet	<a href="http://www.wago.com/793-501/000-024">www.wago.com/793-501/000-024</a>
	<b>Nr. articol: 793-5501</b> WMB marking card; as card; for terminal block width 5 - 17.5 mm; stretchable 5 - 5.2 mm; plain; snap-on type; white	<a href="http://www.wago.com/793-5501">www.wago.com/793-5501</a>
	<b>Nr. articol: 793-5501/000-002</b> WMB marking card; as card; for terminal block width 5 - 17.5 mm; stretchable 5 - 5.2 mm; plain; snap-on type; yellow	<a href="http://www.wago.com/793-5501/000-002">www.wago.com/793-5501/000-002</a>
	<b>Nr. articol: 793-5501/000-005</b> WMB marking card; as card; for terminal block width 5 - 17.5 mm; stretchable 5 - 5.2 mm; plain; snap-on type; red	<a href="http://www.wago.com/793-5501/000-005">www.wago.com/793-5501/000-005</a>
	<b>Nr. articol: 793-5501/000-006</b> WMB marking card; as card; for terminal block width 5 - 17.5 mm; stretchable 5 - 5.2 mm; plain; snap-on type; blue	<a href="http://www.wago.com/793-5501/000-006">www.wago.com/793-5501/000-006</a>
	<b>Nr. articol: 793-5501/000-007</b> WMB marking card; as card; for terminal block width 5 - 17.5 mm; stretchable 5 - 5.2 mm; plain; snap-on type; gray	<a href="http://www.wago.com/793-5501/000-007">www.wago.com/793-5501/000-007</a>
	<b>Nr. articol: 793-5501/000-012</b> WMB marking card; as card; for terminal block width 5 - 17.5 mm; stretchable 5 - 5.2 mm; plain; snap-on type; orange	<a href="http://www.wago.com/793-5501/000-012">www.wago.com/793-5501/000-012</a>
	<b>Nr. articol: 793-5501/000-017</b> WMB marking card; as card; for terminal block width 5 - 17.5 mm; stretchable 5 - 5.2 mm; plain; snap-on type; green	<a href="http://www.wago.com/793-5501/000-017">www.wago.com/793-5501/000-017</a>
	<b>Nr. articol: 793-5501/000-023</b> WMB marking card; as card; for terminal block width 5 - 17.5 mm; stretchable 5 - 5.2 mm; plain; snap-on type; light green	<a href="http://www.wago.com/793-5501/000-023">www.wago.com/793-5501/000-023</a>
	<b>Nr. articol: 793-5501/000-024</b> WMB marking card; as card; for terminal block width 5 - 17.5 mm; stretchable 5 - 5.2 mm; plain; snap-on type; violet	<a href="http://www.wago.com/793-5501/000-024">www.wago.com/793-5501/000-024</a>
<b>ferrule</b>		
	<b>Nr. articol: 216-101</b> Ferrule; Sleeve for 0.5 mm <sup>2</sup> / AWG 22; uninsulated; electro-tin plated	<a href="http://www.wago.com/216-101">www.wago.com/216-101</a>
	<b>Nr. articol: 216-102</b> Ferrule; Sleeve for 0.75 mm <sup>2</sup> / AWG 20; uninsulated; electro-tin plated	<a href="http://www.wago.com/216-102">www.wago.com/216-102</a>
	<b>Nr. articol: 216-103</b> Ferrule; Sleeve for 1 mm <sup>2</sup> / AWG 18; uninsulated; electro-tin plated	<a href="http://www.wago.com/216-103">www.wago.com/216-103</a>
	<b>Nr. articol: 216-104</b> Ferrule; Sleeve for 1.5 mm <sup>2</sup> / AWG 16; uninsulated; electro-tin plated	<a href="http://www.wago.com/216-104">www.wago.com/216-104</a>



















Supus modificărilor.

WAGO Kontakttechnik GmbH & Co. KG  
/Representative Office Romania  
Sos. Pipera-Tunari nr. 1/1  
building 1, 2nd floor | 077190 Voluntari, Ilfov  
Tel.: +40-(0)31 421 85 68 | Email: info-RO@wago.com

Aveți întrebări despre produsele noastre?  
Vă stăm la dispoziție pentru preluarea apelului la +40 (0) 31 421 85 68.

	<b>Nr. articol: 216-201</b> Ferrule; Sleeve for 0.5 mm <sup>2</sup> / 20 AWG; insulated; electro-tin plated; white	<a href="http://www.wago.com/216-201">www.wago.com/216-201</a>
	<b>Nr. articol: 216-202</b> Ferrule; Sleeve for 0.75 mm <sup>2</sup> / 18 AWG; insulated; electro-tin plated; gray	<a href="http://www.wago.com/216-202">www.wago.com/216-202</a>
	<b>Nr. articol: 216-203</b> Ferrule; Sleeve for 1 mm <sup>2</sup> / AWG 18; insulated; electro-tin plated; red	<a href="http://www.wago.com/216-203">www.wago.com/216-203</a>
	<b>Nr. articol: 216-204</b> Ferrule; Sleeve for 1.5 mm <sup>2</sup> / AWG 16; insulated; electro-tin plated; black	<a href="http://www.wago.com/216-204">www.wago.com/216-204</a>
	<b>Nr. articol: 216-301</b> Ferrule; Sleeve for 0.25 mm <sup>2</sup> / AWG 24; insulated; electro-tin plated; yellow	<a href="http://www.wago.com/216-301">www.wago.com/216-301</a>
	<b>Nr. articol: 216-302</b> Ferrule; Sleeve for 0.34 mm <sup>2</sup> / 22 AWG; insulated; electro-tin plated; green	<a href="http://www.wago.com/216-302">www.wago.com/216-302</a>
<b>Jumper</b>		
	<b>Nr. articol: 210-103</b> Wire commoning chain; insulated; 50 connections; black	<a href="http://www.wago.com/210-103">www.wago.com/210-103</a>
	<b>Nr. articol: 210-123</b> Wire commoning chain; insulated; 50 connections	<a href="http://www.wago.com/210-123">www.wago.com/210-123</a>
	<b>Nr. articol: 249-123</b> Push-in type wire jumper; insulated; wire length 180 mm; Conductor cross section 0.75 mm <sup>2</sup>	<a href="http://www.wago.com/249-123">www.wago.com/249-123</a>
	<b>Nr. articol: 249-125</b> Push-in type wire jumper; insulated; wire length 60 mm; Conductor cross section 0.75 mm <sup>2</sup>	<a href="http://www.wago.com/249-125">www.wago.com/249-125</a>
	<b>Nr. articol: 249-126</b> Push-in type wire jumper; insulated; wire length 110 mm; Conductor cross section 0.75 mm <sup>2</sup>	<a href="http://www.wago.com/249-126">www.wago.com/249-126</a>
	<b>Nr. articol: 249-127</b> Push-in type wire jumper; insulated; wire length 250 mm; Conductor cross section 0.75 mm <sup>2</sup>	<a href="http://www.wago.com/249-127">www.wago.com/249-127</a>
	<b>Nr. articol: 280-402</b> Adjacent jumper; insulated; IN = IN terminal block; gray	<a href="http://www.wago.com/280-402">www.wago.com/280-402</a>
	<b>Nr. articol: 280-409</b> Alternate jumper; insulated; IN = IN terminal block; gray	<a href="http://www.wago.com/280-409">www.wago.com/280-409</a>
	<b>Nr. articol: 280-422</b> Adjacent jumper; insulated; IN = IN terminal block; yellow-green	<a href="http://www.wago.com/280-422">www.wago.com/280-422</a>
	<b>Nr. articol: 280-482</b> Comb-style jumper bar; insulated; 2-way; IN = IN terminal block; gray	<a href="http://www.wago.com/280-482">www.wago.com/280-482</a>
	<b>Nr. articol: 280-483</b> Comb-style jumper bar; insulated; 3-way; IN = IN terminal block; gray	<a href="http://www.wago.com/280-483">www.wago.com/280-483</a>
	<b>Nr. articol: 280-484</b> Comb-style jumper bar; insulated; 4-way; IN = IN terminal block; gray	<a href="http://www.wago.com/280-484">www.wago.com/280-484</a>















Supus modificărilor.

	<b>Nr. articol: 280-485</b> Comb-style jumper bar; insulated; 5-way; IN = IN terminal block; gray	<a href="http://www.wago.com/280-485">www.wago.com/280-485</a>
	<b>Nr. articol: 280-490</b> Comb-style jumper bar; insulated; 10-way; IN = IN terminal block; gray	<a href="http://www.wago.com/280-490">www.wago.com/280-490</a>
	<b>Nr. articol: 280-492</b> Alternate comb-style jumper bar; insulated; 2-way; IN = IN terminal block; gray	<a href="http://www.wago.com/280-492">www.wago.com/280-492</a>
	<b>Nr. articol: 283-414</b> Step-down jumper; insulated; from 16 mm <sup>2</sup> to 4 mm <sup>2</sup> ; Nominal current 32 A; gray	<a href="http://www.wago.com/283-414">www.wago.com/283-414</a>
	<b>Nr. articol: 284-414</b> Step-down jumper; insulated; from 10/6 mm <sup>2</sup> to 4/2.5/1.5 mm <sup>2</sup> ; Nominal current 15 A; gray	<a href="http://www.wago.com/284-414">www.wago.com/284-414</a>
	<b>Nr. articol: 709-110</b> Wire commoning chain; insulated; 4 connections; 3 x 110 mm; black	<a href="http://www.wago.com/709-110">www.wago.com/709-110</a>
	<b>Nr. articol: 709-111</b> Wire commoning chain; insulated; 3 connections; 2 x 120 mm; black	<a href="http://www.wago.com/709-111">www.wago.com/709-111</a>
	<b>Nr. articol: 709-112</b> Wire commoning chain; insulated; 3 connections; 2 x 170 mm; black	<a href="http://www.wago.com/709-112">www.wago.com/709-112</a>
	<b>Nr. articol: 780-452</b> Staggered jumper; insulated; from 1 to 2; Spacing: 5 mm; suitable for 2-conductor female plugs; gray	<a href="http://www.wago.com/780-452">www.wago.com/780-452</a>
	<b>Nr. articol: 780-453</b> Staggered jumper; insulated; from 1 to 3; Spacing: 5 mm; suitable for 2-conductor female plugs; gray	<a href="http://www.wago.com/780-453">www.wago.com/780-453</a>
	<b>Nr. articol: 780-454</b> Staggered jumper; insulated; from 1 to 4; Spacing: 5 mm; suitable for 2-conductor female plugs; gray	<a href="http://www.wago.com/780-454">www.wago.com/780-454</a>
	<b>Nr. articol: 780-455</b> Staggered jumper; insulated; from 1 to 5; Spacing: 5 mm; suitable for 2-conductor female plugs; gray	<a href="http://www.wago.com/780-455">www.wago.com/780-455</a>
	<b>Nr. articol: 780-456</b> Staggered jumper; insulated; from 1 to 6; Spacing: 5 mm; suitable for 2-conductor female plugs; gray	<a href="http://www.wago.com/780-456">www.wago.com/780-456</a>
	<b>Nr. articol: 780-457</b> Staggered jumper; insulated; from 1 to 7; Spacing: 5 mm; suitable for 2-conductor female plugs; gray	<a href="http://www.wago.com/780-457">www.wago.com/780-457</a>
	<b>Nr. articol: 780-458</b> Staggered jumper; insulated; from 1 to 8; Spacing: 5 mm; suitable for 2-conductor female plugs; gray	<a href="http://www.wago.com/780-458">www.wago.com/780-458</a>
<b>End plate</b>		
	<b>Nr. articol: 280-324</b> End and intermediate plate; 2.5 mm thick; gray	<a href="http://www.wago.com/280-324">www.wago.com/280-324</a>
	<b>Nr. articol: 280-326</b> End and intermediate plate; 2.5 mm thick; orange	<a href="http://www.wago.com/280-326">www.wago.com/280-326</a>
	<b>Nr. articol: 280-344</b> Separator plate; 2 mm thick; oversized; gray	<a href="http://www.wago.com/280-344">www.wago.com/280-344</a>

Supus modificărilor.

WAGO Kontakttechnik GmbH & Co. KG  
/Representative Office Romania  
Sos. Pipera-Tunari nr. 1/1  
building 1, 2nd floor | 077190 Voluntari, Ilfov  
Tel.: +40-(0)31 421 85 68 | Email: info-RO@wago.com

Aveți întrebări despre produsele noastre?  
Vă stăm la dispoziție pentru preluarea apelului la +40 (0) 31 421 85 68.

	<b>Nr. articol: 280-346</b> Separator plate; 2 mm thick; oversized; orange	<a href="http://www.wago.com/280-346">www.wago.com/280-346</a>
	<b>Nr. articol: 284-334</b> Step-down cover plate; 1 mm thick; for 2-, 3- and 4-conductor terminal blocks; gray	<a href="http://www.wago.com/284-334">www.wago.com/284-334</a>
	<b>Nr. articol: 284-344</b> Step-down cover plate; 1 mm thick; for 2-, 3- and 4-conductor terminal blocks; orange	<a href="http://www.wago.com/284-344">www.wago.com/284-344</a>
<b>Insulation stop</b>		
	<b>Nr. articol: 280-470</b> Insulation stop; 0.08 - 0.2 mm <sup>2</sup> "s" (0.14 mm <sup>2</sup> "f-st"); 5 pieces/strip; white	<a href="http://www.wago.com/280-470">www.wago.com/280-470</a>
	<b>Nr. articol: 280-471</b> Insulation stop; 0.25 - 0.5 mm <sup>2</sup> ; 5 pieces/strip; light gray	<a href="http://www.wago.com/280-471">www.wago.com/280-471</a>
	<b>Nr. articol: 280-472</b> Insulation stop; 0.75 - 1 mm <sup>2</sup> ; 5 pieces/strip	<a href="http://www.wago.com/280-472">www.wago.com/280-472</a>
<b>plug</b>		
	<b>Nr. articol: 280-803</b> Empty component plug housing; 10 mm wide; Type 4; 2-pole; gray	<a href="http://www.wago.com/280-803">www.wago.com/280-803</a>
	<b>Nr. articol: 280-803/281-411</b> Component plug; 2-pole; with diode 1N4007; 10 mm wide; gray	<a href="http://www.wago.com/280-803/281-411">www.wago.com/280-803/281-411</a>
	<b>Nr. articol: 280-803/281-413</b> Component plug; 2-pole; LED (red); 24 VDC; 10 mm wide; gray	<a href="http://www.wago.com/280-803/281-413">www.wago.com/280-803/281-413</a>
	<b>Nr. articol: 280-803/281-414</b> Component plug; 2-pole; LED (red); 48 VDC; 10 mm wide; gray	<a href="http://www.wago.com/280-803/281-414">www.wago.com/280-803/281-414</a>
	<b>Nr. articol: 280-803/281-415</b> Component plug; 2-pole; LED (red); 10 mm wide; gray	<a href="http://www.wago.com/280-803/281-415">www.wago.com/280-803/281-415</a>
	<b>Nr. articol: 280-803/281-416</b> Component plug; 2-pole; LED (red); 10 mm wide; gray	<a href="http://www.wago.com/280-803/281-416">www.wago.com/280-803/281-416</a>
	<b>Nr. articol: 280-803/281-417</b> Component plug; 2-pole; 10 mm wide; gray	<a href="http://www.wago.com/280-803/281-417">www.wago.com/280-803/281-417</a>
	<b>Nr. articol: 280-803/281-418</b> Component plug; 2-pole; 10 mm wide; gray	<a href="http://www.wago.com/280-803/281-418">www.wago.com/280-803/281-418</a>

Supus modificărilor.

WAGO Kontakttechnik GmbH & Co. KG  
/Representative Office Romania  
Sos. Pipera-Tunari nr. 1/1  
building 1, 2nd floor | 077190 Voluntari, Ilfov  
Tel.: +40-(0)31 421 85 68 | Email: info-RO@wago.com

Aveți întrebări despre produsele noastre?  
Vă stăm la dispoziție pentru preluarea apelului la +40 (0) 31 421 85 68.

**Nr. articol: 280-803/281-420**

Component plug; for carrier terminal blocks; 2-pole; with rectifier diode and LED; 10 mm wide; gray

[www.wago.com/280-803/281-420](http://www.wago.com/280-803/281-420)**Nr. articol: 280-803/281-421**

Component plug; for carrier terminal blocks; 2-pole; with rectifier diode and LED; 10 mm wide; gray

[www.wago.com/280-803/281-421](http://www.wago.com/280-803/281-421)**tools****Nr. articol: 210-657**

Operating tool; Blade: 3.5 x 0.5 mm; with a partially insulated shaft; short

[www.wago.com/210-657](http://www.wago.com/210-657)**Nr. articol: 210-658**

Operating tool; Blade: 3.5 x 0.5 mm; with a partially insulated shaft; angled; short

[www.wago.com/210-658](http://www.wago.com/210-658)**Nr. articol: 210-720**

Operating tool; Blade: 3.5 x 0.5 mm; with a partially insulated shaft

[www.wago.com/210-720](http://www.wago.com/210-720)**check****Nr. articol: 209-170**Test plug adapter; 8.3 mm wide; for 4 mm Ø test plugs; suitable for 1.5 mm<sup>2</sup> - 10 mm<sup>2</sup> tbs; gray[www.wago.com/209-170](http://www.wago.com/209-170)**Nr. articol: 249-106**B-type test plug module; modular; 1,50 mm<sup>2</sup>; gray[www.wago.com/249-106](http://www.wago.com/249-106)**Nr. articol: 249-107**

B-type spacer module; modular; e.g., for bridging commoned terminal blocks; gray

[www.wago.com/249-107](http://www.wago.com/249-107)**Nr. articol: 249-141**L-type test plug module; modular; with spring-loaded contact pin; Center module; 1,50 mm<sup>2</sup>; gray[www.wago.com/249-141](http://www.wago.com/249-141)**Nr. articol: 280-404**Test plug adapter; 5 mm wide; for test plug 210-137 (2.3 mm Ø); suitable for 1.5 mm<sup>2</sup> - 4 mm<sup>2</sup> tbs; gray[www.wago.com/280-404](http://www.wago.com/280-404)**Nr. articol: 280-418**

Test plug module; modular; suitable for all WAGO 280 and 780 Series rail-mounted terminal blocks with jumper slots in the current bar; gray

[www.wago.com/280-418](http://www.wago.com/280-418)**Nr. articol: 280-419**

Spacer module; modular; bridging commoned terminal blocks; gray

[www.wago.com/280-419](http://www.wago.com/280-419)**Protective Warning Marker****Nr. articol: 280-415**

Protective warning marker; with high-voltage symbol, black; for 5 terminal blocks; yellow

[www.wago.com/280-415](http://www.wago.com/280-415)**Descărcări****Documentation****Additional Information**

Technical explanations

Apr 3, 2019

pdf  
2,1 MB

Descărcare

Supus modificărilor.

WAGO Kontakttechnik GmbH & Co. KG  
/Representative Office Romania  
Sos. Pipera-Tunari nr. 1/1  
building 1, 2nd floor | 077190 Voluntari, Ilfov  
Tel.: +40-(0)31 421 85 68 | Email: info-RO@wago.com

Aveți întrebări despre produsele noastre?  
Vă stăm la dispoziție pentru preluarea apelului la +40 (0) 31 421 85 68.

## CAD/CAE-Data

### CAD data

2D/3D Models 280-681

[URL](#)

[Descărcare](#)

### CAE data

EPLAN Data Portal 280-681

[URL](#)

[Descărcare](#)

WSCAD Universe 280-681

[URL](#)

[Descărcare](#)

## Installation Notes

### Assembly

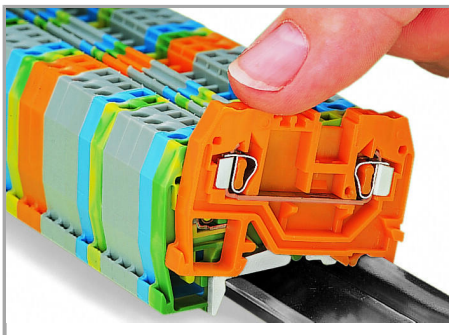

Snapping a terminal block onto the carrier rail.

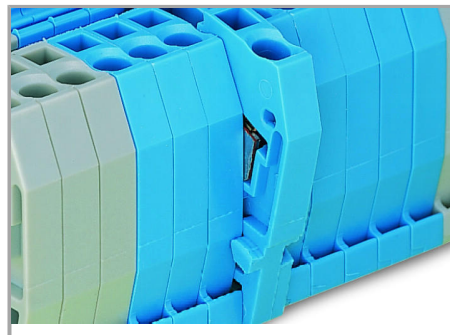

Quick assembly keys prevent reverse mounting.

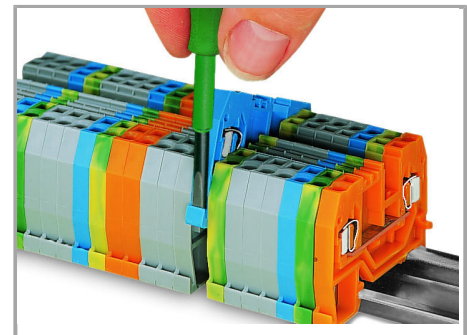

Removing a terminal block from the assembly.

### Inserting a conductor

Supus modificărilor.



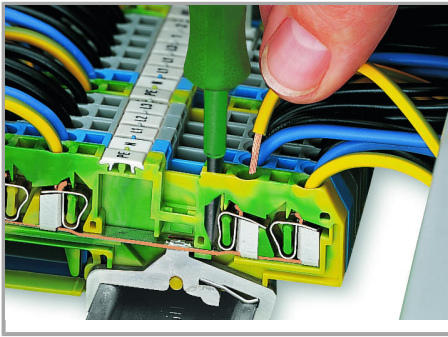

CAGE CLAMP® connection

Inserting a conductor.



CAGE CLAMP® connection

Inserting a conductor.

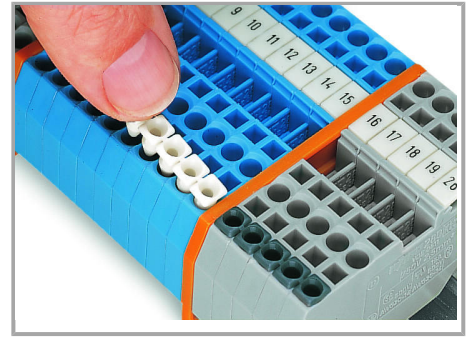

Inserting insulation stops.

With ferruled conductors, it is necessary to use a terminal block one size larger than the conductor's nominal cross-section.

#### Commoning

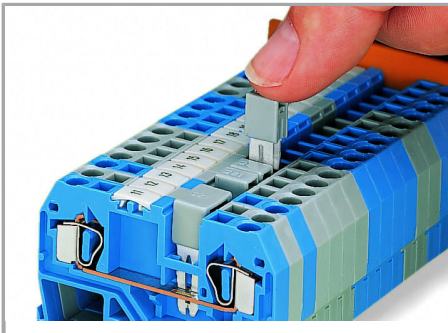

Commoning using an adjacent jumper (280-402).

Push jumper down until fully inserted.

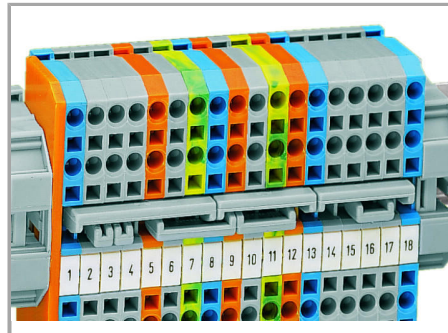

Staggered jumpers for sophisticated circuit requirements – push jumpers down until fully inserted.

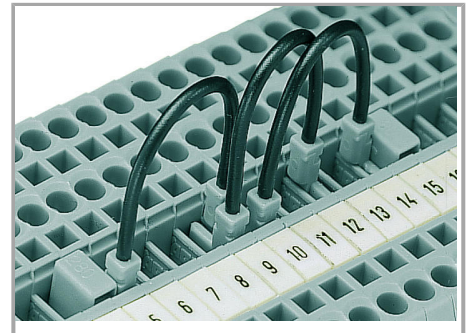

Wire jumpers

When installing machines or control systems, it is often necessary to make an additional connection between two terminal blocks that are not next to each other on the rail. In such cases, WAGO's touch-proof, push-in type wire jumpers are the ideal solution.

Supus modificărilor.



These jumpers are compatible with the following rail-mount terminal blocks:

- 279 Series (1.5 mm<sup>2</sup>/16 AWG),
- 
- 280/775/780 Series (2.5 mm<sup>2</sup>/14 AWG)
- 
- 281/769/776/777/781 and 880 Series (4 mm<sup>2</sup>/12 AWG)
- 

They are available in three conductor lengths (60, 110 and 250 mm), allowing up to 60 terminal blocks to be commoned depending on their width (see table on the right).

Compared with the 279 Series, the 280/775/780 and 281/776/777/781 Series can also accommodate two wire jumpers, allowing the use of commoning chains. Furthermore, the 280/769/775/780/880 and 281/776/777/781 Series allow both wire jumper and adjacent jumper to be simultaneously plugged into a same terminal block.

## Testing

Supus modificărilor.

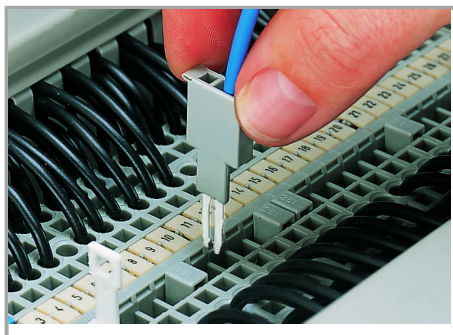

Testing with a test plug

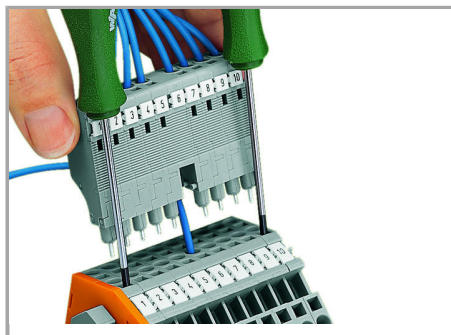

L-type test plug modules fitted with CAGE CLAMP®

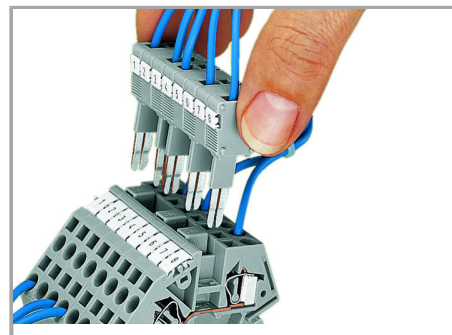

B-type test plug modules fitted with CAGE CLAMP®

(picture shows a test plug fitted with CAGE CLAMP®).

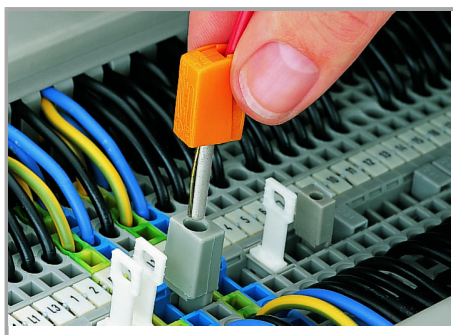

Testing with a test plug

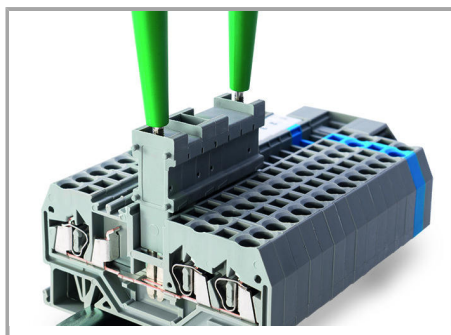

The test plug modules are directly plugged into the jumper contact slot of the current bar.

(picture shows 209-170 Test Plug Adapter).

## Cover

Supus modificărilor.

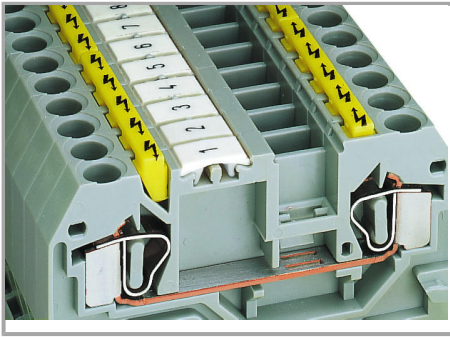

Protective warning markers inserted into the operating slots.

### Marking

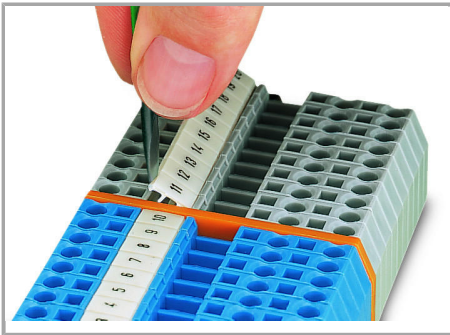

Marking via WMB Multi Marking System.

Supus modificărilor.