

## Fișă tehnică | Număr articol: 285-195

2-conductor through terminal block; 95 mm<sup>2</sup>; lateral marker slots; only for  
DIN 35 x 15 rail; POWER CAGE CLAMP; 95,00 mm<sup>2</sup>; gray

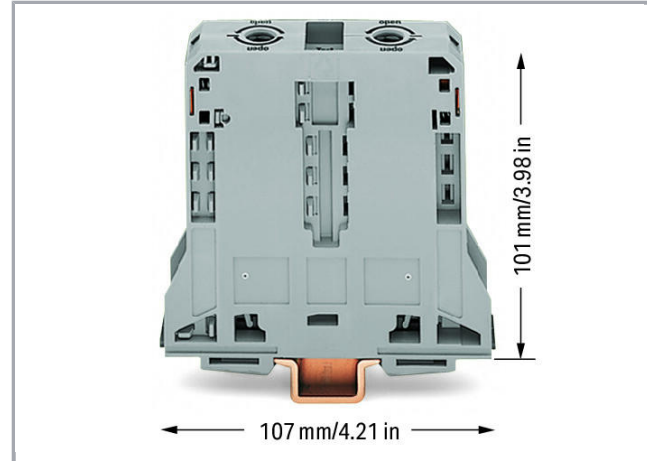

[www.wago.com/285-195](http://www.wago.com/285-195)

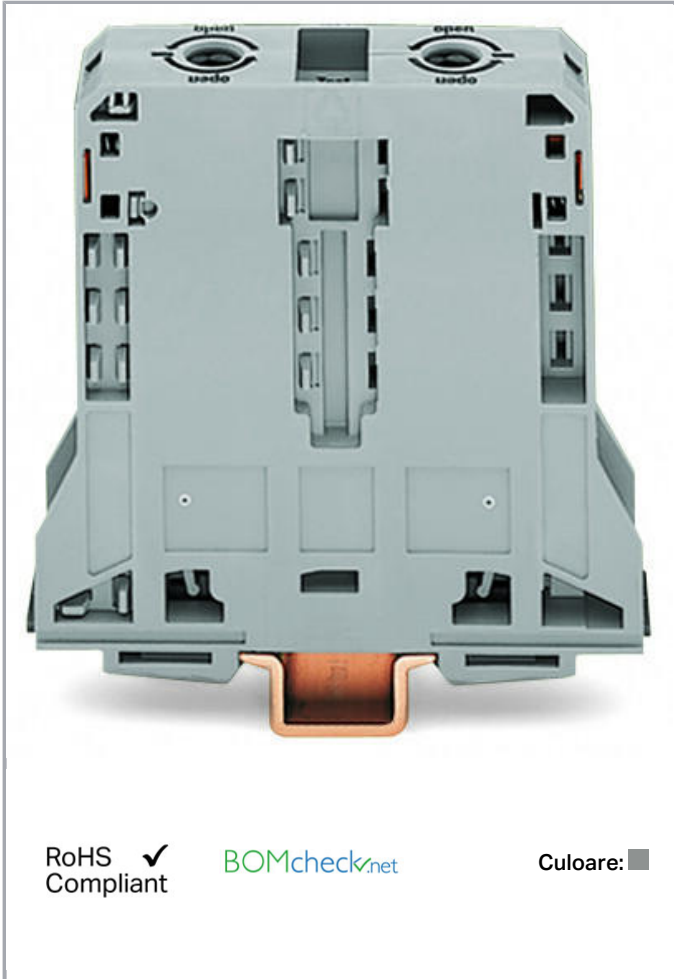

RoHS   
Compliant

[BOMcheck.net](https://www.bomcheck.net)

Culoare: ■

### Date

#### Electrical data

Voltage type 1

AC/DC

Voltage type 2

DC

#### Ratings per IEC/EN 60664-1

Ratings per

IEC/EN 60947-7-1

Nominal voltage (III/3)

1000 V

Supus modificărilor.

WAGO Kontakttechnik GmbH & Co. KG  
/Representative Office Romania  
Sos. Pipera-Tunari nr. 1/1  
building 1, 2nd floor | 077190 Voluntari, Ilfov  
Tel.: +40-(0)31 421 85 68 | Email: [info-RO@wago.com](mailto:info-RO@wago.com)

Aveți întrebări despre produsele noastre?  
Vă stăm la dispoziție pentru preluarea apelului la +40 (0) 31 421 85 68.



Rated surge voltage (III/3)	12 kV
Rated current	232 A
Rated voltage (III/3) 2	1500 V
Rated surge voltage (III/3) 2	12 kV
Legend (ratings)	(III / 3) $\hat{=}$ Overvoltage category III / Pollution degree 3

### Connection data

Connection technology	POWER CAGE CLAMP
Actuation type	Operating tool
Connectable conductor materials	Copper
Solid conductor	25 ... 95 mm <sup>2</sup> / 4 ... 4/0 AWG
Stranded conductor	25 ... 95 mm <sup>2</sup> / 4 ... 4/0 AWG
Fine-stranded conductor	25 ... 95 mm <sup>2</sup> / 4 ... 4/0 AWG
Strip length	35 mm / 1.38 inch
Total number of connection points	2
Total number of potentials	1
Number of levels	1
Wiring type	Side-entry wiring

### Geometrical Data

Width	25 mm / 0.984 inch
Height from upper-edge of DIN-rail	101 mm / 3.976 inch
Depth	107 mm / 4.213 inch

### Mechanical data

Design	horizontal type
Mounting type	DIN-35 rail
Marking level	Side marking

### Material Data

Color	gray
Insulation material	Polyamide 66 (PA 66)
Fire load	3,564 MJ
Weight	264,3 g

Supus modificărilor.

WAGO Kontakttechnik GmbH & Co. KG  
 /Representative Office Romania  
 Sos. Pipera-Tunari nr. 1/1  
 building 1, 2nd floor | 077190 Voluntari, Ilfov  
 Tel.: +40-(0)31 421 85 68 | Email: info-RO@wago.com



Aveți întrebări despre produsele noastre?  
 Vă stăm la dispoziție pentru preluarea apelului la +40 (0) 31 421 85 68.

## Commercial data



Product Group	1 (Rail Mounted Terminal Blocks)
Packaging type	BOX
Country of origin	PL
GTIN	4044918452564
Customs tariff number	85369010000

## Aprobări / certificate

## Country specific Approvals

Emblemă	Aprobare	Text de aprobare suplimentar	Nume certificat
	<b>CCA</b> DEKRA Certification B.V.	EN 60947	NTR NL-7707
	<b>CSA</b> DEKRA Certification B.V.	C22.2 No. 158	1151144
	<b>KEMA/KEUR</b> DEKRA Certification B.V.	EN 60947	71-101911

## Ship Approvals

Emblemă	Aprobare	Text de aprobare suplimentar	Nume certificat
	<b>ABS</b> American Bureau of Shipping	EN 60947	20-HG1941090-PDA
	<b>BV</b> Bureau Veritas S.A.	EN 60947	07436/E0 BV
	<b>DNV GL</b> Det Norske Veritas, Germanischer Lloyd	-	TAE00001V2
	<b>LR</b>	EN 60947	91/20112

Supus modificărilor.

WAGO Kontakttechnik GmbH & Co. KG  
 /Representative Office Romania  
 Sos. Pipera-Tunari nr. 1/1  
 building 1, 2nd floor | 077190 Voluntari, Ilfov  
 Tel.: +40-(0)31 421 85 68 | Email: info-RO@wago.com

Aveți întrebări despre produsele noastre?  
 Vă stăm la dispoziție pentru preluarea apelului la +40 (0) 31 421 85 68.



Lloyds Register

(E9)



## UL-Approvals

Emblemă	Aprobare	Text de aprobare suplimentar	Nume certificat
	UL Underwriters Laboratories Inc.	UL 1059	E45172

## Counterpart

## Produse compatibile













## Marking accessories

	<b>Nr. articol: 2009-115</b> WMB-Inline; for Smart Printer; 1500 pieces on roll; stretchable 5 - 5.2 mm; plain; snap-on type; white	<a href="http://www.wago.com/2009-115">www.wago.com/2009-115</a>
	<b>Nr. articol: 2009-115/000-002</b> WMB-Inline; for Smart Printer; 1500 pieces on roll; stretchable 5 - 5.2 mm; plain; snap-on type; yellow	<a href="http://www.wago.com/2009-115/000-002">www.wago.com/2009-115/000-002</a>
	<b>Nr. articol: 2009-115/000-005</b> WMB-Inline; for Smart Printer; 1500 pieces on roll; stretchable 5 - 5.2 mm; plain; snap-on type; red	<a href="http://www.wago.com/2009-115/000-005">www.wago.com/2009-115/000-005</a>
	<b>Nr. articol: 2009-115/000-006</b> WMB-Inline; for Smart Printer; 1500 pieces on roll; stretchable 5 - 5.2 mm; plain; snap-on type; blue	<a href="http://www.wago.com/2009-115/000-006">www.wago.com/2009-115/000-006</a>
	<b>Nr. articol: 2009-115/000-007</b> WMB-Inline; for Smart Printer; 1500 pieces on roll; stretchable 5 - 5.2 mm; plain; snap-on type; gray	<a href="http://www.wago.com/2009-115/000-007">www.wago.com/2009-115/000-007</a>

Supus modificărilor.

WAGO Kontakttechnik GmbH & Co. KG  
 /Representative Office Romania  
 Sos. Pipera-Tunari nr. 1/1  
 building 1, 2nd floor | 077190 Voluntari, Ilfov  
 Tel.: +40-(0)31 421 85 68 | Email: info-RO@wago.com

Aveți întrebări despre produsele noastre?  
 Vă stăm la dispoziție pentru preluarea apelului la +40 (0) 31 421 85 68.

	<b>Nr. articol: 2009-115/000-012</b> WMB-Inline; for Smart Printer; 1500 pieces on roll; stretchable 5 - 5.2 mm; plain; snap-on type; orange	<a href="http://www.wago.com/2009-115/000-012">www.wago.com/2009-115/000-012</a>
	<b>Nr. articol: 2009-115/000-017</b> WMB-Inline; for Smart Printer; 1500 pieces on roll; stretchable 5 - 5.2 mm; plain; snap-on type; light green	<a href="http://www.wago.com/2009-115/000-017">www.wago.com/2009-115/000-017</a>
	<b>Nr. articol: 2009-115/000-023</b> WMB-Inline; for Smart Printer; 1500 pieces on roll; stretchable 5 - 5.2 mm; plain; snap-on type; green	<a href="http://www.wago.com/2009-115/000-023">www.wago.com/2009-115/000-023</a>
	<b>Nr. articol: 2009-115/000-024</b> WMB-Inline; for Smart Printer; 1500 pieces on roll; stretchable 5 - 5.2 mm; plain; snap-on type; violet	<a href="http://www.wago.com/2009-115/000-024">www.wago.com/2009-115/000-024</a>
	<b>Nr. articol: 209-185</b> Adaptor; gray	<a href="http://www.wago.com/209-185">www.wago.com/209-185</a>
	<b>Nr. articol: 249-105</b> Group marker carrier; gray	<a href="http://www.wago.com/249-105">www.wago.com/249-105</a>
	<b>Nr. articol: 285-442</b> Adaptor; gray	<a href="http://www.wago.com/285-442">www.wago.com/285-442</a>
	<b>Nr. articol: 793-501</b> WMB marking card; as card; not stretchable; plain; snap-on type; white	<a href="http://www.wago.com/793-501">www.wago.com/793-501</a>
	<b>Nr. articol: 793-501/000-002</b> WMB marking card; as card; not stretchable; plain; snap-on type; yellow	<a href="http://www.wago.com/793-501/000-002">www.wago.com/793-501/000-002</a>
	<b>Nr. articol: 793-501/000-005</b> WMB marking card; as card; not stretchable; plain; snap-on type; red	<a href="http://www.wago.com/793-501/000-005">www.wago.com/793-501/000-005</a>
	<b>Nr. articol: 793-501/000-006</b> WMB marking card; as card; not stretchable; plain; snap-on type; blue	<a href="http://www.wago.com/793-501/000-006">www.wago.com/793-501/000-006</a>
	<b>Nr. articol: 793-501/000-007</b> WMB marking card; as card; not stretchable; plain; snap-on type; gray	<a href="http://www.wago.com/793-501/000-007">www.wago.com/793-501/000-007</a>
	<b>Nr. articol: 793-501/000-012</b> WMB marking card; as card; not stretchable; plain; snap-on type; orange	<a href="http://www.wago.com/793-501/000-012">www.wago.com/793-501/000-012</a>
	<b>Nr. articol: 793-501/000-017</b> WMB marking card; as card; not stretchable; plain; snap-on type; light green	<a href="http://www.wago.com/793-501/000-017">www.wago.com/793-501/000-017</a>
	<b>Nr. articol: 793-501/000-023</b> WMB marking card; as card; not stretchable; plain; snap-on type; green	<a href="http://www.wago.com/793-501/000-023">www.wago.com/793-501/000-023</a>

Supus modificărilor.



**Nr. articol: 793-501/000-024**  
WMB marking card; as card; not stretchable; plain; snap-on type; violet

[www.wago.com/793-501/000-024](http://www.wago.com/793-501/000-024)



**Nr. articol: 793-5501**  
WMB marking card; as card; for terminal block width 5 - 17.5 mm; stretchable 5 - 5.2 mm; plain; snap-on type; white

[www.wago.com/793-5501](http://www.wago.com/793-5501)



**Nr. articol: 793-5501/000-002**  
WMB marking card; as card; for terminal block width 5 - 17.5 mm; stretchable 5 - 5.2 mm; plain; snap-on type; yellow

[www.wago.com/793-5501/000-002](http://www.wago.com/793-5501/000-002)



**Nr. articol: 793-5501/000-005**  
WMB marking card; as card; for terminal block width 5 - 17.5 mm; stretchable 5 - 5.2 mm; plain; snap-on type; red

[www.wago.com/793-5501/000-005](http://www.wago.com/793-5501/000-005)



**Nr. articol: 793-5501/000-006**  
WMB marking card; as card; for terminal block width 5 - 17.5 mm; stretchable 5 - 5.2 mm; plain; snap-on type; blue

[www.wago.com/793-5501/000-006](http://www.wago.com/793-5501/000-006)



**Nr. articol: 793-5501/000-007**  
WMB marking card; as card; for terminal block width 5 - 17.5 mm; stretchable 5 - 5.2 mm; plain; snap-on type; gray

[www.wago.com/793-5501/000-007](http://www.wago.com/793-5501/000-007)



**Nr. articol: 793-5501/000-012**  
WMB marking card; as card; for terminal block width 5 - 17.5 mm; stretchable 5 - 5.2 mm; plain; snap-on type; orange

[www.wago.com/793-5501/000-012](http://www.wago.com/793-5501/000-012)



**Nr. articol: 793-5501/000-014**  
WMB marking card; as card; for terminal block width 5 - 17.5 mm; stretchable 5 - 5.2 mm; plain; snap-on type; brown

[www.wago.com/793-5501/000-014](http://www.wago.com/793-5501/000-014)



**Nr. articol: 793-5501/000-017**  
WMB marking card; as card; for terminal block width 5 - 17.5 mm; stretchable 5 - 5.2 mm; plain; snap-on type; green

[www.wago.com/793-5501/000-017](http://www.wago.com/793-5501/000-017)



**Nr. articol: 793-5501/000-023**  
WMB marking card; as card; for terminal block width 5 - 17.5 mm; stretchable 5 - 5.2 mm; plain; snap-on type; light green

[www.wago.com/793-5501/000-023](http://www.wago.com/793-5501/000-023)



**Nr. articol: 793-5501/000-024**  
WMB marking card; as card; for terminal block width 5 - 17.5 mm; stretchable 5 - 5.2 mm; plain; snap-on type; violet

[www.wago.com/793-5501/000-024](http://www.wago.com/793-5501/000-024)

#### Jumper



**Nr. articol: 285-495**  
Adjacent jumper; insulated; Nominal current 232 A for 1 jumper; Nominal current 192 A for 2 to 4 jumpers; gray

[www.wago.com/285-495](http://www.wago.com/285-495)

#### potential distribution

**Nr. articol: 285-407**

Supus modificărilor.



Power tap; for 95 mm<sup>2</sup> high-current tbs; 10,00 mm<sup>2</sup>; gray

[www.wago.com/285-407](http://www.wago.com/285-407)

#### tools



Nr. articol: 285-172

Allen wrench; with a partially insulated shaft

[www.wago.com/285-172](http://www.wago.com/285-172)



Nr. articol: 285-173

Allen wrench; with a partially insulated shaft; with anti-rotation protection

[www.wago.com/285-173](http://www.wago.com/285-173)

#### Protective Warning Marker



Nr. articol: 285-170

Protective warning marker; with high-voltage symbol, black; yellow

[www.wago.com/285-170](http://www.wago.com/285-170)



Nr. articol: 285-175

Protective warning marker; yellow

[www.wago.com/285-175](http://www.wago.com/285-175)

#### protection



Nr. articol: 285-169

Finger guard; touchproof cover protects unused conductor entries and jumper slots; for 95 mm<sup>2</sup> high-current tbs; yellow

[www.wago.com/285-169](http://www.wago.com/285-169)

#### assembling



Nr. articol: 210-148

Angled support bracket; without screw

[www.wago.com/210-148](http://www.wago.com/210-148)



Nr. articol: 249-117

Screwless end stop; 10 mm wide; for DIN-rail 35 x 15 and 35 x 7.5; gray

[www.wago.com/249-117](http://www.wago.com/249-117)



Nr. articol: 249-197

Screwless end stop; 14 mm wide; for DIN-rail 35 x 15 and 35 x 7.5; gray

[www.wago.com/249-197](http://www.wago.com/249-197)

#### ferrule



Nr. articol: 216-413

Ferrule; Sleeve for 25 mm<sup>2</sup> / AWG 4; uninsulated; electro-tin plated; electrolytic copper; gastight crimped; acc. to DIN 46228, Part 1/08.92

[www.wago.com/216-413](http://www.wago.com/216-413)



Nr. articol: 216-414

Ferrule; Sleeve for 35 mm<sup>2</sup> / AWG 2; uninsulated; electro-tin plated; electrolytic copper; gastight crimped; acc. to DIN 46228, Part 1/08.92

[www.wago.com/216-414](http://www.wago.com/216-414)



Nr. articol: 216-424

Ferrule; Sleeve for 35 mm<sup>2</sup> / AWG 2; uninsulated; electro-tin plated; electrolytic copper; gastight crimped; acc. to DIN 46228, Part 1/08.92

[www.wago.com/216-424](http://www.wago.com/216-424)



Nr. articol: 216-425

Ferrule; Sleeve for 50 mm<sup>2</sup> / AWG 1; uninsulated; electro-tin plated; electrolytic copper; gastight crimped; acc. to DIN 46228, Part 1/08.92

[www.wago.com/216-425](http://www.wago.com/216-425)



Nr. articol: 216-435

Ferrule; Sleeve for 50 mm<sup>2</sup> / AWG 1; uninsulated; electro-tin plated; electrolytic copper; gastight crimped; acc. to DIN 46228, Part 1/08.92

[www.wago.com/216-435](http://www.wago.com/216-435)



#### Carrier rail

Nr. articol: 210-114

Steel carrier rail; 35 x 15 mm; 1.5 mm thick; 2 m long; unslotted; similar to EN 60715

[www.wago.com/210-114](http://www.wago.com/210-114)

Supus modificărilor.

	<b>Nr. articol: 210-197</b> Steel carrier rail; 35 x 15 mm; 1.5 mm thick; 2 m long; slotted; similar to EN 60715	<a href="http://www.wago.com/210-197">www.wago.com/210-197</a>
	<b>Nr. articol: 210-198</b> Copper carrier rail; 35 x 15 mm; 2.3 mm thick; 2 m long; unslotted; according to EN 60715; copper-colored	<a href="http://www.wago.com/210-198">www.wago.com/210-198</a>
	<b>Nr. articol: 210-506</b> Steel carrier rail; 35 x 15 mm; 1.5 mm thick; 2 m long; unslotted; galvanized; similar to EN 60715	<a href="http://www.wago.com/210-506">www.wago.com/210-506</a>
	<b>Nr. articol: 210-508</b> Steel carrier rail; 35 x 15 mm; 1.5 mm thick; 2 m long; slotted; galvanized; similar to EN 60715	<a href="http://www.wago.com/210-508">www.wago.com/210-508</a>
<b>General accessories</b>		
	<b>Nr. articol: 855-951/250-000</b> Current and voltage tap up to 95 mm <sup>2</sup> ; Primary rated current: 250 A; Secondary rated current: 1 A; Rated power: 0.2 VA; Accuracy class: 0.5; fused	<a href="http://www.wago.com/855-951/250-000">www.wago.com/855-951/250-000</a>

## Descărcări

### Documentation

#### Additional Information

Technical explanations	Apr 3, 2019	pdf 2,1 MB	Descărcare
------------------------	-------------	---------------	------------

### CAD/CAE-Data

#### CAD data

2D/3D Models 285-195	URL	Descărcare
----------------------	-----	------------

#### CAE data

EPLAN Data Portal 285-195	URL	Descărcare
---------------------------	-----	------------

WSCAD Universe 285-195	URL	Descărcare
------------------------	-----	------------

### Installation Notes

#### Conductor termination

Supus modificărilor.



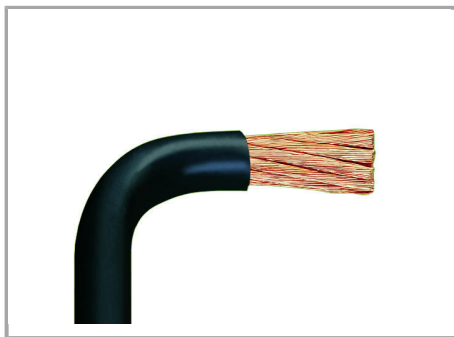

For the optimal clamping force:

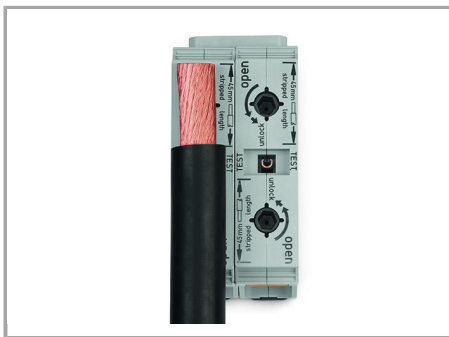

Always observe the printed strip length!

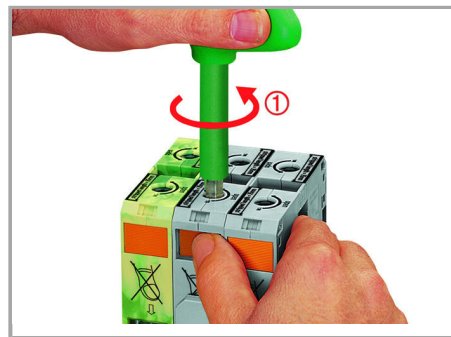

Conductor termination – step 1

- Bend conductor.
- 
- Cut conductor to length (conductor end must be straight).
- 
- Strip conductor.
- 

Rotate the T-wrench counter-clockwise to the stop. Next, push in the orange locking tab. The clamp is locked open for hands-free wiring.

Supus modificărilor.

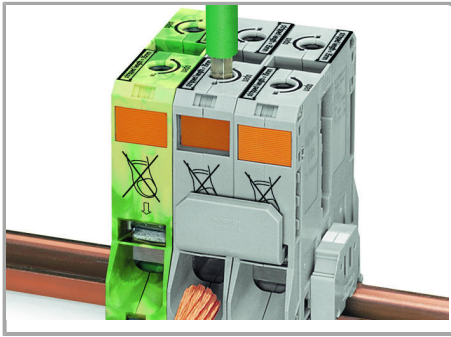

Conductor termination – step 2



Conductor termination – step 3

Insert a stripped conductor into the clamping unit until it hits backstop. Hold in this position.

A short counter-clockwise rotation releases the locking tab. When unlocked, the T-wrench rotates clockwise, securely clamping the conductor.

#### Commoning

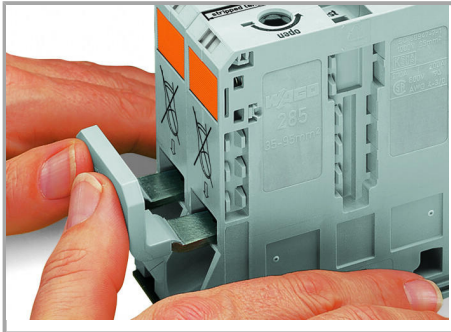

Commoning with an adjacent jumper: Insert the jumper above the conductor entry hole – prior to conductor termination. The nominal cross-section remains unchanged.

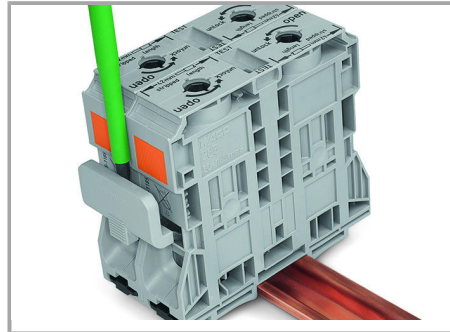

Removing jumper via operating tool.

#### Cover

Supus modificărilor.

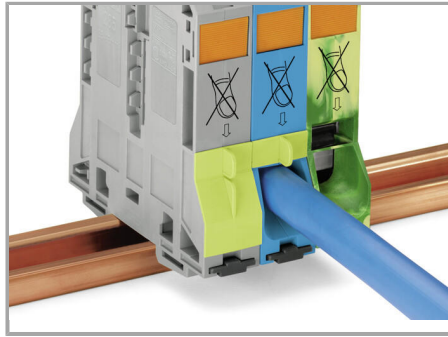
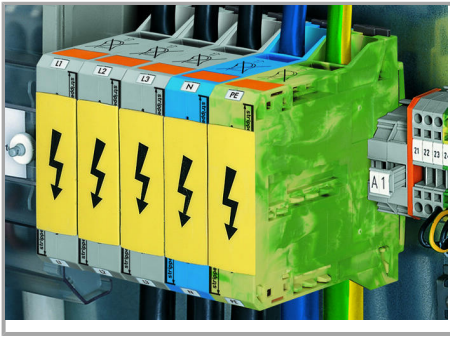

Protective warning marker may indicate:

Yellow, detachable finger guards provide touch-proof safety by shielding jumper contact slots and/or unused conductor entries.

Notice: Power is still on even after switching off the main switch!

#### Voltage Tap

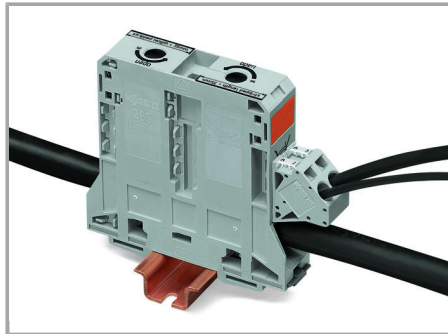
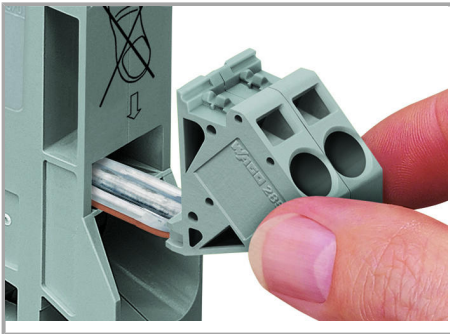

Reliably and easily tap directly into the power supply. Insert the unwired tap before opening the clamping unit.

#### Safety

Supus modificărilor.

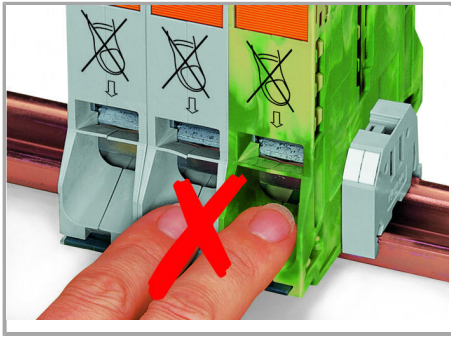

Risk of Injury!

Do not insert fingers in the conductor entry!

### Testing



Testing via touch-proof 4 mm Ø test plugs (not available from WAGO, but offered by industry suppliers such as, Multi-Contact Deutschland GmbH).

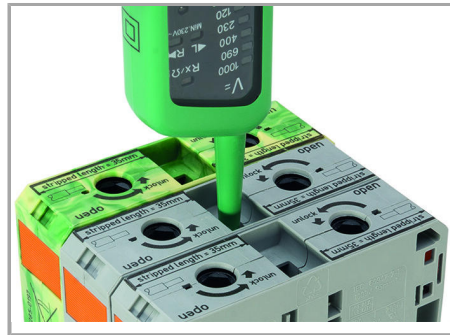

Testing

### Marking

Supus modificărilor.

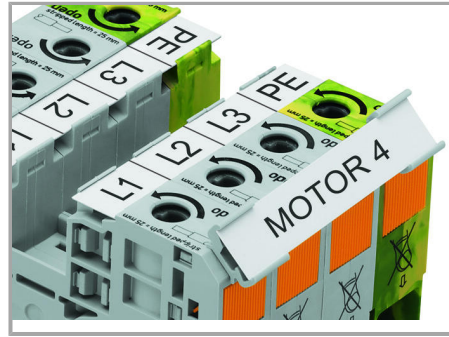
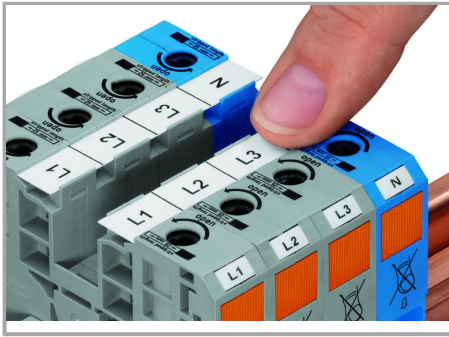

WMB markers or self-adhesive, printable marking strips can be accommodated on 35, 50 and 95 mm<sup>2</sup> high-current terminal blocks.

Marker carrier for marking strips (2009-110) or 2 x WMB markers for 285-13x, 285-15x and 285-19x terminal blocks

## Familie de produse

### POWER CAGE CLAMP

Afișare globală produse din familie.

Supus modificărilor.

WAGO Kontakttechnik GmbH & Co. KG  
/Representative Office Romania  
Sos. Pipera-Tunari nr. 1/1  
building 1, 2nd floor | 077190 Voluntari, Ilfov  
Tel.: +40-(0)31 421 85 68 | Email: [info-RO@wago.com](mailto:info-RO@wago.com)

Aveți întrebări despre produsele noastre?

Vă stăm la dispoziție pentru preluarea apelului la +40 (0) 31 421 85 68.