

## Fișă tehnică | Număr articol: 773-604

PUSH WIRE® connector for junction boxes; for solid conductors; max. 4 mm<sup>2</sup>; 4-conductor; Brown clear housing; red cover; Surrounding air temperature: max 60°C; 2,50 mm<sup>2</sup>

[www.wago.com/773-604](http://www.wago.com/773-604)

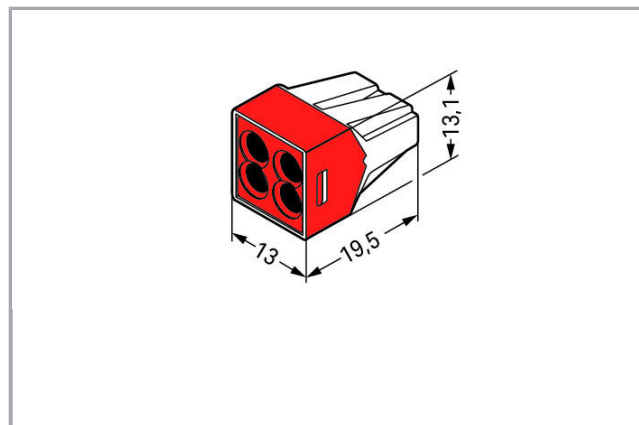
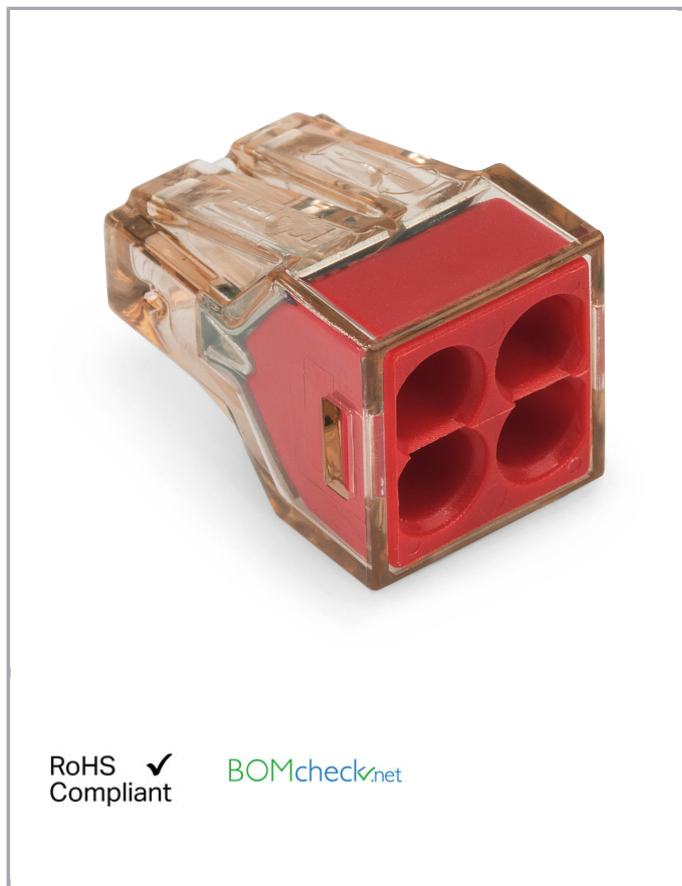

### Descriere articol

#### Note:

##### Terminating Aluminum Conductors

WAGO spring clamp terminal blocks are suitable for solid aluminum conductors up to 4 mm<sup>2</sup>/12 AWG if WAGO "Alu-Plus" Contact Paste is used for termination.

"Alu-Plus" Contact Paste Advantages:

- Automatically destroys the oxide film during clamping.
- Prevents fresh oxidation at the clamping point.
- Prevents electrolytic corrosion between aluminum and copper conductors (in the same terminal block).
- Provides long-term protection against corrosion.

Supus modificărilor.

WAGO Kontakttechnik GmbH & Co. KG  
/Representative Office Romania  
Sos. Pipera-Tunari nr. 1/1  
building 1, 2nd floor | 077190 Voluntari, Ilfov  
Tel.: +40-(0)31 421 85 68 | Email: info-RO@wago.com

Aveți întrebări despre produsele noastre?  
Vă stăm la dispoziție pentru preluarea apelului la +40 (0) 31 421 85 68.



For spring clamp connections with PUSH WIRE® connection technology, **WAGO recommends that the aluminum conductor first be cleaned** and then immediately inserted into the clamping unit filled with "Alu-Plus" contact paste.

It is also possible to apply WAGO "Alu-Plus" **additionally** on the whole surface of the aluminum conductor before termination.

Please note that the nominal currents must be adapted to the reduced conductivity of the aluminum conductors::

2.5 mm<sup>2</sup> = 16 A

4 mm<sup>2</sup> = 22 A

## Date

### Electrical data

#### Ratings per IEC/EN 60664-1

Ratings per	IEC/EN 60664-1
Nominal voltage (II/2)	400 V
Rated surge voltage (II/2)	4 kV
Rated current	32 A
Legend (ratings)	(II / 2) ≙ Overvoltage category II / Pollution degree 2

### Connection data

Connection technology	PUSH WIRE®
Actuation type	Push-in
Connectable conductor materials	Copper Aluminum
Strip length	12 mm / 0.47 inch
Total number of connection points	6
Total number of potentials	1
Wiring type	Side-entry wiring

### Geometrical Data

Width	13 mm / 0.512 inch
Height	13,1 mm / 0.516 inch
Depth	19,5 mm / 0.768 inch

### Material Data

Cover color	red
-------------	-----

Supus modificărilor.

WAGO Kontakttechnik GmbH & Co. KG  
/Representative Office Romania  
Sos. Pipera-Tunari nr. 1/1  
building 1, 2nd floor | 077190 Voluntari, Ilfov  
Tel.: +40-(0)31 421 85 68 | Email: info-RO@wago.com

Aveți întrebări despre produsele noastre?  
Vă stăm la dispoziție pentru preluarea apelului la +40 (0) 31 421 85 68.

Flammability class per UL94	V2
Weight	2,4 g

### Environmental Requirements

Surrounding air temperature (operation)	60 °C
Continuous operating temperature	105 °C

### Commercial data

Product Group	7 (Push Wire Conn.)
Packaging type	BOX
Country of origin	CN
GTIN	4055143243681
Customs tariff number	85369010000

### Aprobări / certificate

#### Ship Approvals

Emblemă	Aprobare	Text de aprobare suplimentar	Nume certificat
	<b>ABS</b> American Bureau of Shipping	-	18- HG1755093- PDA

#### UL-Approvals

Emblemă	Aprobare	Text de aprobare suplimentar	Nume certificat
	<b>UL</b> UL International Germany GmbH	EN 60998	D- 03479- A1

### Counterpart

### Produse compatibile

#### Mounting adapter

Nr. articol: 773-332

Supus modificărilor.

WAGO Kontakttechnik GmbH & Co. KG  
/Representative Office Romania  
Sos. Pipera-Tunari nr. 1/1  
building 1, 2nd floor | 077190 Voluntari, Ilfov  
Tel.: +40-(0)31 421 85 68 | Email: info-RO@wago.com

Aveți întrebări despre produsele noastre?  
Vă stăm la dispoziție pentru preluarea apelului la +40 (0) 31 421 85 68.



Mounting carrier; 773 Series - 2.5 mm<sup>2</sup> / 4 mm<sup>2</sup> / 6 mm<sup>2</sup>; for DIN-35 rail mounting/screw mounting; orange

[www.wago.com/773-332](http://www.wago.com/773-332)

#### General accessories



Nr. articol: 249-130  
Syringe; Contents: 20 ml Alu-Plus contact paste

[www.wago.com/249-130](http://www.wago.com/249-130)

## Descărcări

### Documentation

#### Additional Information

Technical explanations

Apr 3, 2019

pdf  
2,1 MB

Descărcare

## Installation Notes

### Conductor termination

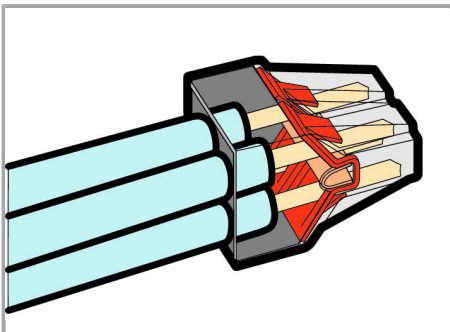

PUSH WIRE® connector for junction boxes, 773 Series

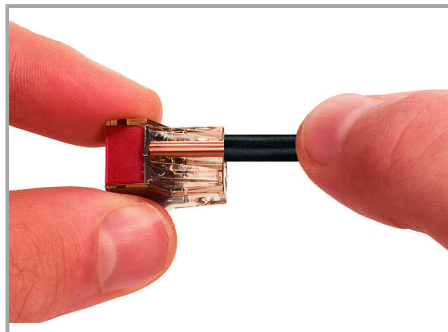

Strip solid conductor to 12 mm (0.47 inch).

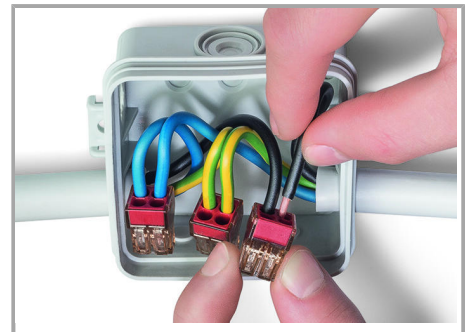

Termination: Insert stripped solid conductor until it hits backstop.

Supus modificărilor.

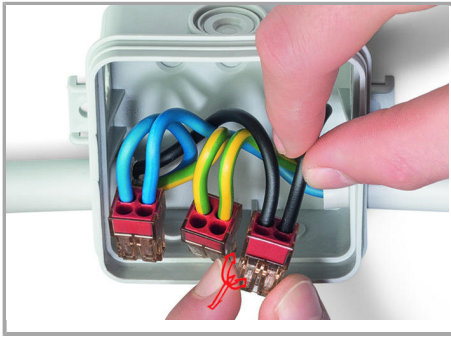

Removal: Hold conductor to be removed and twist alternately left and right while pulling the connector.

#### Testing

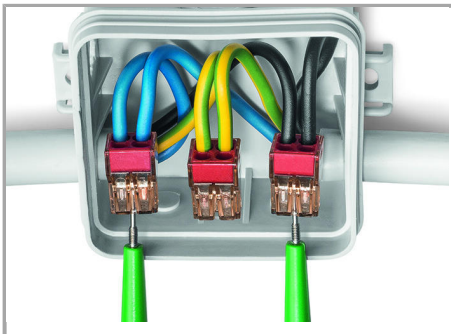

Testing via test ports opposite to conductor entry.

Supus modificărilor.