

Fișă tehnică | Număr articol: 2004-911

Fuse plug; with pull-tab; for miniature metric fuses 5 x 20 mm and 5 x 25 mm;
without blown fuse indication; 6.1 mm wide; gray

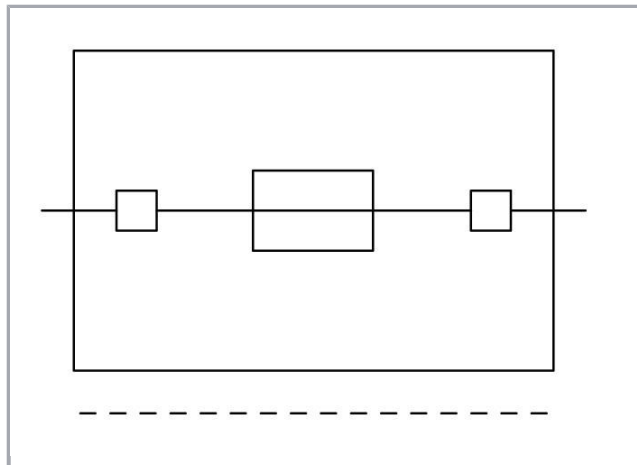

www.wago.com/2004-911

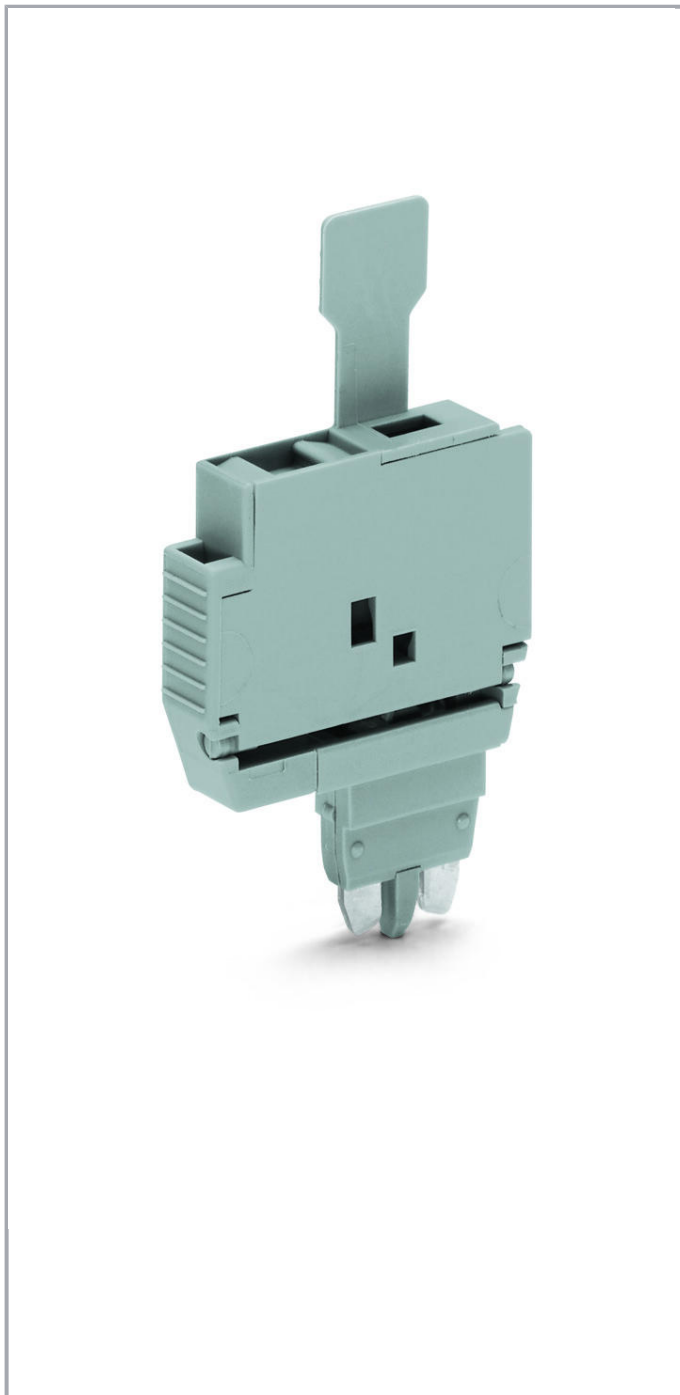

Supus modificărilor.

WAGO Kontakttechnik GmbH & Co. KG
/Representative Office Romania
Sos. Pipera-Tunari nr. 1/1
building 1, 2nd floor | 077190 Voluntari, Ilfov
Tel.: +40-(0)31 421 85 68 | Email: info-RO@wago.com

Aveți întrebări despre produsele noastre?
Vă stăm la dispoziție pentru preluarea apelului la +40 (0) 31 421 85 68.

RoHS 
Compliant

BOMcheck.net

Culoare: 

Descriere articol

Safety information 1:

Electrical ratings are given by the fuse.

Date

Electrical data

Ratings per IEC/EN 60664-1

Nominal voltage (III/3)	250 V
Rated current	6,3 A

Geometrical Data

Width	6,1 mm / 0.24 inch
-------	--------------------

Mechanical data

Marking level	Center marking
---------------	----------------

Material Data

Color	gray
Insulation material	Polyamide 66 (PA 66)
Fire load	0,063 MJ
Weight	4 g

Commercial data

Product Group	22 (TOPJOB S)
Packaging type	BOX
Country of origin	CN
GTIN	4055143043991
Customs tariff number	85366990990



Supus modificărilor.

WAGO Kontakttechnik GmbH & Co. KG
/Representative Office Romania
Sos. Pipera-Tunari nr. 1/1
building 1, 2nd floor | 077190 Voluntari, Ilfov
Tel.: +40-(0)31 421 85 68 | Email: info-RO@wago.com

Aveți întrebări despre produsele noastre?
Vă stăm la dispoziție pentru preluarea apelului la +40 (0) 31 421 85 68.

Aprobări / certificate

Country specific Approvals

Emblemă	Aprobare	Text de aprobare suplimentar	Nume certificat
	CCA DEKRA Certification B.V.	EN 60947	NTR NL 7730
	CSA DEKRA Certification B.V.	C22.2 No. 158	1536069
	KEMA/KEUR DEKRA Certification B.V.	EN 60947	71- 107687



UL-Approvals

Emblemă	Aprobare	Text de aprobare suplimentar	Nume certificat
	UR Underwriters Laboratories Inc.	UL 1059	E45172

Counterpart

Produse compatibile











Marking accessories

	Nr. articol: 2009-110 Marking strips; on reel; not stretchable; plain; snap-on type; white	www.wago.com/2009-110
	Nr. articol: 2009-115 WMB-Inline; for Smart Printer; 1500 pieces on roll; stretchable 5 - 5.2 mm; plain; snap-on type; white	www.wago.com/2009-115
	Nr. articol: 2009-115/000-002 WMB-Inline; for Smart Printer; 1500 pieces on roll; stretchable 5 - 5.2 mm; plain; snap-on type; yellow	www.wago.com/2009-115/000-002

Supus modificărilor.

WAGO Kontakttechnik GmbH & Co. KG
/Representative Office Romania
Sos. Pipera-Tunari nr. 1/1
building 1, 2nd floor | 077190 Voluntari, Ilfov
Tel.: +40-(0)31 421 85 68 | Email: info-RO@wago.com

Aveți întrebări despre produsele noastre?
Vă stăm la dispoziție pentru preluarea apelului la +40 (0) 31 421 85 68.

	Nr. articol: 2009-115/000-006 WMB-Inline; for Smart Printer; 1500 pieces on roll; stretchable 5 - 5.2 mm; plain; snap-on type; blue	www.wago.com/2009-115/000-006
	Nr. articol: 2009-115/000-007 WMB-Inline; for Smart Printer; 1500 pieces on roll; stretchable 5 - 5.2 mm; plain; snap-on type; gray	www.wago.com/2009-115/000-007
	Nr. articol: 2009-115/000-012 WMB-Inline; for Smart Printer; 1500 pieces on roll; stretchable 5 - 5.2 mm; plain; snap-on type; orange	www.wago.com/2009-115/000-012
	Nr. articol: 2009-115/000-017 WMB-Inline; for Smart Printer; 1500 pieces on roll; stretchable 5 - 5.2 mm; plain; snap-on type; light green	www.wago.com/2009-115/000-017
	Nr. articol: 2009-115/000-023 WMB-Inline; for Smart Printer; 1500 pieces on roll; stretchable 5 - 5.2 mm; plain; snap-on type; green	www.wago.com/2009-115/000-023
	Nr. articol: 2009-115/000-024 WMB-Inline; for Smart Printer; 1500 pieces on roll; stretchable 5 - 5.2 mm; plain; snap-on type; violet	www.wago.com/2009-115/000-024
	Nr. articol: 793-501 WMB marking card; as card; not stretchable; plain; snap-on type; white	www.wago.com/793-501
	Nr. articol: 793-501/000-002 WMB marking card; as card; not stretchable; plain; snap-on type; yellow	www.wago.com/793-501/000-002
	Nr. articol: 793-501/000-005 WMB marking card; as card; not stretchable; plain; snap-on type; red	www.wago.com/793-501/000-005
	Nr. articol: 793-501/000-006 WMB marking card; as card; not stretchable; plain; snap-on type; blue	www.wago.com/793-501/000-006
	Nr. articol: 793-501/000-007 WMB marking card; as card; not stretchable; plain; snap-on type; gray	www.wago.com/793-501/000-007
	Nr. articol: 793-501/000-012 WMB marking card; as card; not stretchable; plain; snap-on type; orange	www.wago.com/793-501/000-012
	Nr. articol: 793-501/000-017 WMB marking card; as card; not stretchable; plain; snap-on type; light green	www.wago.com/793-501/000-017

Supus modificărilor.

WAGO Kontakttechnik GmbH & Co. KG
 /Representative Office Romania
 Sos. Pipera-Tunari nr. 1/1
 building 1, 2nd floor | 077190 Voluntari, Ilfov
 Tel.: +40-(0)31 421 85 68 | Email: info-RO@wago.com

Aveți întrebări despre produsele noastre?
 Vă stăm la dispoziție pentru preluarea apelului la +40 (0) 31 421 85 68.



Nr. articol: 793-501/000-023
WMB marking card; as card; not stretchable; plain; snap-on type; green

www.wago.com/793-501/000-023



Nr. articol: 793-501/000-024
WMB marking card; as card; not stretchable; plain; snap-on type; violet

www.wago.com/793-501/000-024



Nr. articol: 793-5501
WMB marking card; as card; for terminal block width 5 - 17.5 mm; stretchable 5 - 5.2 mm; plain; snap-on type; white

www.wago.com/793-5501



Nr. articol: 793-5501/000-002
WMB marking card; as card; for terminal block width 5 - 17.5 mm; stretchable 5 - 5.2 mm; plain; snap-on type; yellow

www.wago.com/793-5501/000-002



Nr. articol: 793-5501/000-005
WMB marking card; as card; for terminal block width 5 - 17.5 mm; stretchable 5 - 5.2 mm; plain; snap-on type; red

www.wago.com/793-5501/000-005



Nr. articol: 793-5501/000-006
WMB marking card; as card; for terminal block width 5 - 17.5 mm; stretchable 5 - 5.2 mm; plain; snap-on type; blue

www.wago.com/793-5501/000-006



Nr. articol: 793-5501/000-007
WMB marking card; as card; for terminal block width 5 - 17.5 mm; stretchable 5 - 5.2 mm; plain; snap-on type; gray

www.wago.com/793-5501/000-007



Nr. articol: 793-5501/000-012
WMB marking card; as card; for terminal block width 5 - 17.5 mm; stretchable 5 - 5.2 mm; plain; snap-on type; orange

www.wago.com/793-5501/000-012



Nr. articol: 793-5501/000-017
WMB marking card; as card; for terminal block width 5 - 17.5 mm; stretchable 5 - 5.2 mm; plain; snap-on type; green

www.wago.com/793-5501/000-017



Nr. articol: 793-5501/000-023
WMB marking card; as card; for terminal block width 5 - 17.5 mm; stretchable 5 - 5.2 mm; plain; snap-on type; light green

www.wago.com/793-5501/000-023



Nr. articol: 793-5501/000-024
WMB marking card; as card; for terminal block width 5 - 17.5 mm; stretchable 5 - 5.2 mm; plain; snap-on type; violet

www.wago.com/793-5501/000-024

General accessories



Nr. articol: 281-503
Shorting link; 5 x 20 mm; if the fuse plug is used as disconnect plug

www.wago.com/281-503

clamps



Nr. articol: 2002-1661
2-conductor carrier terminal block; for DIN-rail 35 x 15 and 35 x 7.5; 2.5 mm²; Push-in CAGE CLAMP®; 2,50 mm²; gray

www.wago.com/2002-1661

Nr. articol: 2002-1761

Supus modificărilor.



3-conductor carrier terminal block; for DIN-rail 35 x 15 and 35 x 7.5; 2.5 mm²; Push-in CAGE CLAMP®; 2,50 mm²; gray www.wago.com/2002-1761



Nr. articol: 2002-1861
4-conductor carrier terminal block; for DIN-rail 35 x 15 and 35 x 7.5; 2.5 mm²; Push-in CAGE CLAMP®; 2,50 mm²; gray www.wago.com/2002-1861



Nr. articol: 2002-1961
2-conductor carrier terminal block; with additional jumper position; for DIN-rail 35 x 15 and 35 x 7.5; 2.5 mm²; Push-in CAGE CLAMP®; 2,50 mm²; gray www.wago.com/2002-1961



Nr. articol: 2002-2961
Double-deck carrier terminal block; L/L; for DIN-rail 35 x 15 and 35 x 7.5; 2.5 mm²; Push-in CAGE CLAMP®; 2,50 mm²; gray www.wago.com/2002-2961



Nr. articol: 2002-2963
Double-deck carrier terminal block; L/N; for DIN-rail 35 x 15 and 35 x 7.5; 2.5 mm²; Push-in CAGE CLAMP®; 2,50 mm²; gray www.wago.com/2002-2963

Descărcări Documentation

Additional Information

Technical explanations	Apr 3, 2019	pdf 2,1 MB	Descărcare
------------------------	-------------	---------------	------------

CAD/CAE-Data

CAD data

2D/3D Models 2004-911	URL	Descărcare
-----------------------	-----	------------

CAE data

WSCAD Universe 2004-911	URL	Descărcare
-------------------------	-----	------------

Installation Notes

Supus modificărilor.

WAGO Kontakttechnik GmbH & Co. KG
/Representative Office Romania
Sos. Pipera-Tunari nr. 1/1
building 1, 2nd floor | 077190 Voluntari, Ilfov
Tel.: +40-(0)31 421 85 68 | Email: info-RO@wago.com

Aveți întrebări despre produsele noastre?
Vă stăm la dispoziție pentru preluarea apelului la +40 (0) 31 421 85 68.

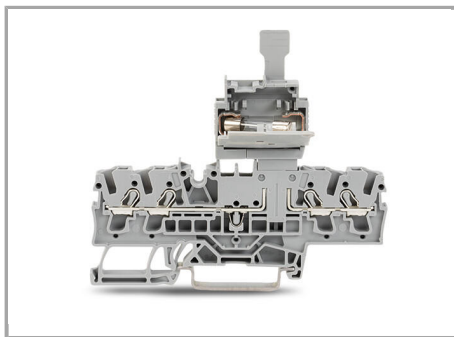

Using fuse plugs with rail-mount terminal blocks for control circuit protection is highly advantageous because the function and wiring levels are separated:

- No additional cost for assembly and wiring
-
- No risk of accidental contact with live parts when disconnecting the fuse plug
-
- The fuse plug is completely separated from the carrier terminal block when replacing a fuse – away from current carrying parts
-
- The fuse plug can be removed by service personnel
-
- No unintentional reclosing of the circuit by another person
-
- Quickly exchange a fuse by using a prepared “stand-by plug”
-

Fuse plug features for quick and safe applications:

- Optional LED indicates blown fuse

Supus modificărilor.

-
- Top-of-unit marking slot provides clear carrier terminal block identification
-
- Two test slots with touch contacts
-
- Terminal blocks/plugs provide high-density wiring in a width of just 6.1 mm
-
- May be used as a disconnect plug in combination with a shorting link
-

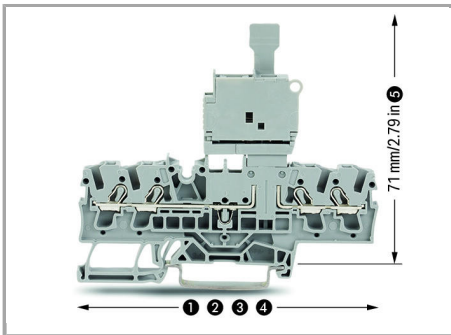

Fuse plug dimensions:

66.1 mm / 2.62 inch for 2002-1661

76.8 mm / 3.02 inch for 2002-1761

87.5 mm / 3.45 inch for 2002-1861

72.9 mm / 2.87 inch for 2002-1961

with inserted fuse plug

Supus modificărilor.

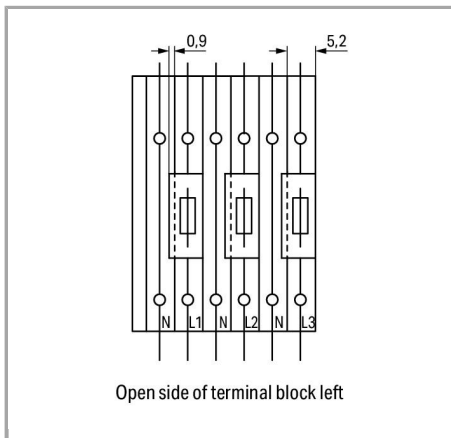

Please note:

The extra width of the plug (6.1 mm compared to 5.2 mm for carrier terminal blocks) must be compensated for with intermediate plates (1 mm) when building an assembly of carrier terminal blocks equipped with fuse plugs.

Supus modificărilor.

Glass cartridge fuses 5 x 20				
Series Item No.	Overload and short circuit protection		Short circuit protection only	
	Individual argmt.	Group argmt.	Individual argmt.	Group argmt.
Fuse terminal blocks				
2004-911				
2004-911/.....	1.6 W	1.6 W	2.5 W	2.5 W

When selecting miniature metric fuses, make sure that the maximum power loss listed above is not exceeded. The power loss is determined according to IEC or EN 60947-7-3/VDE 0611-6 at 23 °C. The temperature rise of the terminal blocks must be checked according to their application and mounting. Higher ambient temperatures place additional strain on fuse cartridges. Therefore, in such applications, the rated current must be reduced if necessary. More details are available from the fuse manufacturers.

Familie de produse

TOPJOB® S

TOPJOB® S: In various industrial applications and modern building installations, WAGO's wide and versatile range of rail-mount terminal blocks provides more than just reliable electrical connections.

[Afișare globală produse din familie.](#)

Supus modificărilor.