

Fișă tehnică | Număr articol: 280-610

3-conductor carrier terminal block; for DIN-rail 35 x 15 and 35 x 7.5; 2.5 mm²; CAGE CLAMP®; 2,50 mm²; gray

www.wago.com/280-610

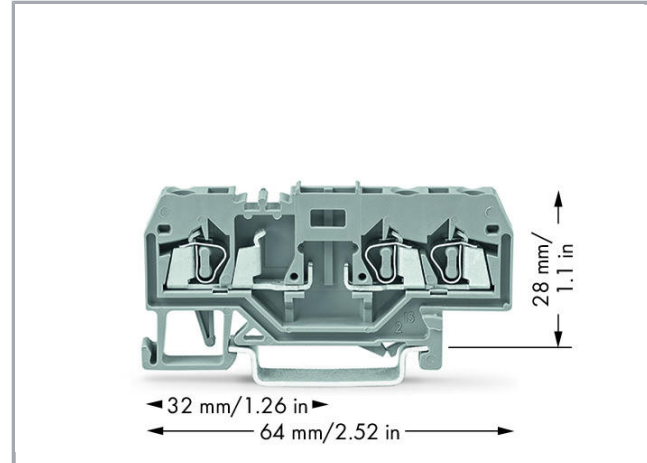
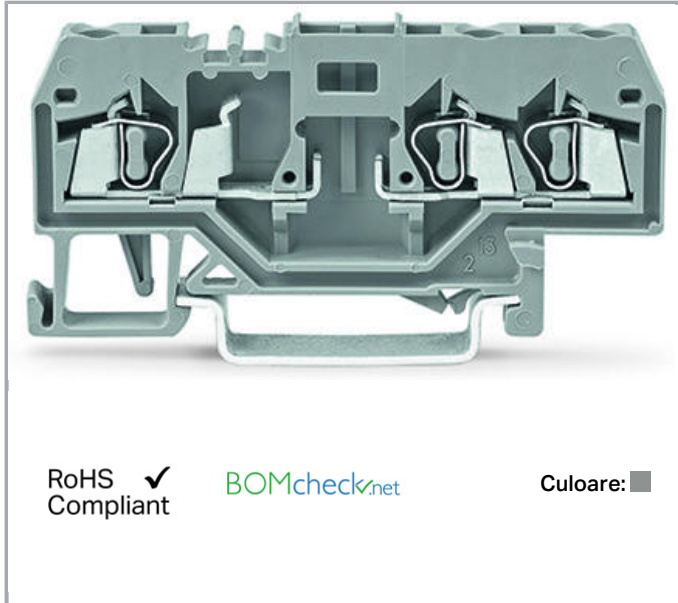

Descriere articol

Note:

Terminating Aluminum Conductors

WAGO spring clamp terminal blocks are suitable for solid aluminum conductors up to 4 mm²/12 AWG if WAGO "Alu-Plus" Contact Paste is used for termination.

"Alu-Plus" Contact Paste Advantages:

- Automatically destroys the oxide film during clamping.
- Prevents fresh oxidation at the clamping point.
- Prevents electrolytic corrosion between aluminum and copper conductors (in the same terminal block).
- Provides long-term protection against corrosion.

Using terminal blocks with CAGE CLAMP® Spring Pressure Connection Technology, **aluminum conductors must first be cleaned with a blade** and then immediately be inserted into the clamping units filled with "Alu-Plus" Contact Paste.

It is also possible to apply WAGO "Alu-Plus" **additionally** on the whole surface of the aluminum conductor before termination.

Supus modificărilor.

WAGO Kontakttechnik GmbH & Co. KG
/Representative Office Romania
Sos. Pipera-Tunari nr. 1/1
building 1, 2nd floor | 077190 Voluntari, Ilfov
Tel.: +40-(0)31 421 85 68 | Email: info-RO@wago.com

Aveți întrebări despre produsele noastre?
Vă stăm la dispoziție pentru preluarea apelului la +40 (0) 31 421 85 68.



Please note that the nominal currents must be adapted to the reduced conductivity of the aluminum conductors:

2.5 mm² (14 AWG) = 16 A

4 mm² (12 AWG) = 22 A

Date

Electrical data

Ratings per IEC/EN 60664-1

Ratings per	IEC/EN 60947-7-1
Nominal voltage (III/3)	400 V
Rated surge voltage (III/3)	6 kV
Rated current	10 A
Legend (ratings)	(III / 3) ≙ Overvoltage category III / Pollution degree 3

Connection data

Connection technology	CAGE CLAMP®
Actuation type	Operating tool
Connectable conductor materials	Copper Aluminum
Solid conductor	0,08 ... 2,5 mm ² / 28 ... 12 AWG
Fine-stranded conductor	0,08 ... 2,5 mm ² / 28 ... 12 AWG
Strip length	8 ... 9 mm / 0.31 ... 0.35 inch
Total number of connection points	3
Total number of potentials	2
Number of levels	1
Wiring type	Front-entry wiring
Note (conductor cross-section)	12 AWG: THHN, THWN

Geometrical Data

Width	5 mm / 0.197 inch
Height from upper-edge of DIN-rail	28 mm / 1.102 inch
Depth	64 mm / 2.52 inch

Mechanical data

Design	horizontal
Mounting type	DIN-35 rail
Marking level	Center marking

Supus modificărilor.

WAGO Kontakttechnik GmbH & Co. KG
/Representative Office Romania
Sos. Pipera-Tunari nr. 1/1
building 1, 2nd floor | 077190 Voluntari, Ilfov
Tel.: +40-(0)31 421 85 68 | Email: info-RO@wago.com

Aveți întrebări despre produsele noastre?
Vă stăm la dispoziție pentru preluarea apelului la +40 (0) 31 421 85 68.

Material Data



Color	gray
Insulation material	Polyamide 66 (PA 66)
Fire load	0,132 MJ
Weight	7,7 g

Commercial data



Product Group	1 (Rail Mounted Terminal Blocks)
Packaging type	BOX
Country of origin	CN
GTIN	4050821214939
Customs tariff number	85369010000

Aprobări / certificate

Country specific Approvals

Emblemă	Aprobare	Text de aprobare suplimentar	Nume certificat
	CCA DEKRA Certification B.V.	EN 60947	2157201.01
	CSA DEKRA Certification B.V.	C22.2	1536071

Ship Approvals

Emblemă	Aprobare	Text de aprobare suplimentar	Nume certificat
	ABS American Bureau of Shipping	EN 60947	20-HG1941090-PDA
	BV Bureau Veritas S.A.	EN 60947	07436/E0 BV
	DNV GL Det Norske Veritas, Germanischer Lloyd	-	TAE00001V2

Supus modificărilor.

WAGO Kontakttechnik GmbH & Co. KG
/Representative Office Romania
Sos. Pipera-Tunari nr. 1/1
building 1, 2nd floor | 077190 Voluntari, Ilfov
Tel.: +40-(0)31 421 85 68 | Email: info-RO@wago.com

Aveți întrebări despre produsele noastre?
Vă stăm la dispoziție pentru preluarea apelului la +40 (0) 31 421 85 68.



LR
Lloyds Register

EN 60947

91/20112
(E9)





UL-Approvals

Emblemă	Aprobare	Text de aprobare suplimentar	Nume certificat
	UL Underwriters Laboratories Inc.	UL 1059	20170731- E45172

Counterpart

Produse compatibile















Carrier rail

	Nr. articol: 210-112 Steel carrier rail; 35 x 7.5 mm; 1 mm thick; 2 m long; slotted; according to EN 60715; "Hole width 25 mm	www.wago.com/210-112
	Nr. articol: 210-113 Steel carrier rail; 35 x 7.5 mm; 1 mm thick; 2 m long; unslotted; according to EN 60715	www.wago.com/210-113
	Nr. articol: 210-114 Steel carrier rail; 35 x 15 mm; 1.5 mm thick; 2 m long; unslotted; similar to EN 60715	www.wago.com/210-114
	Nr. articol: 210-115 Steel carrier rail; 35 x 7.5 mm; 1 mm thick; 2 m long; slotted; according to EN 60715; "Hole width 18 mm	www.wago.com/210-115

Supus modificărilor.















WAGO Kontakttechnik GmbH & Co. KG
/Representative Office Romania
Sos. Pipera-Tunari nr. 1/1
building 1, 2nd floor | 077190 Voluntari, Ilfov
Tel.: +40-(0)31 421 85 68 | Email: info-RO@wago.com

Aveți întrebări despre produsele noastre?
Vă stăm la dispoziție pentru preluarea apelului la +40 (0) 31 421 85 68.















	Nr. articol: 210-118 Steel carrier rail; 35 x 15 mm; 2.3 mm thick; 2 m long; unslotted; according to EN 60715	www.wago.com/210-118
	Nr. articol: 210-196 Aluminum carrier rail; 35 x 8.2 mm; 1.6 mm thick; 2 m long; unslotted; similar to EN 60715; silver-colored	www.wago.com/210-196
	Nr. articol: 210-197 Steel carrier rail; 35 x 15 mm; 1.5 mm thick; 2 m long; slotted; similar to EN 60715	www.wago.com/210-197
	Nr. articol: 210-198 Copper carrier rail; 35 x 15 mm; 2.3 mm thick; 2 m long; unslotted; according to EN 60715; copper-colored	www.wago.com/210-198
	Nr. articol: 210-504 Steel carrier rail; 35 x 7.5 mm; 1 mm thick; 2 m long; slotted; galvanized; according to EN 60715	www.wago.com/210-504
	Nr. articol: 210-505 Steel carrier rail; 35 x 7.5 mm; 1 mm thick; 2 m long; unslotted; galvanized; according to EN 60715	www.wago.com/210-505
	Nr. articol: 210-506 Steel carrier rail; 35 x 15 mm; 1.5 mm thick; 2 m long; unslotted; galvanized; similar to EN 60715	www.wago.com/210-506
	Nr. articol: 210-508 Steel carrier rail; 35 x 15 mm; 1.5 mm thick; 2 m long; slotted; galvanized; similar to EN 60715	www.wago.com/210-508
tools		
	Nr. articol: 210-657 Operating tool; Blade: 3.5 x 0.5 mm; with a partially insulated shaft; short	www.wago.com/210-657
	Nr. articol: 210-658 Operating tool; Blade: 3.5 x 0.5 mm; with a partially insulated shaft; angled; short	www.wago.com/210-658
	Nr. articol: 210-720 Operating tool; Blade: 3.5 x 0.5 mm; with a partially insulated shaft	www.wago.com/210-720
Protective Warning Marker		
	Nr. articol: 280-415 Protective warning marker; with high-voltage symbol, black; for 5 terminal blocks; yellow	www.wago.com/280-415
General accessories		
	Nr. articol: 280-802 Empty component plug housing; gray	www.wago.com/280-802
	Nr. articol: 280-804 Empty component plug housing; 10 mm wide; Type 3; 4-pole; gray	www.wago.com/280-804
	Nr. articol: 286-110 Empty component plug housing; Type 9; 10 mm wide; 4-pole; gray	www.wago.com/286-110
	Nr. articol: 286-111 Empty component plug housing; Type 10; 15 mm wide; 6-pole; gray	www.wago.com/286-111
	Nr. articol: 286-112 Empty component plug housing; Type 11; 20 mm wide; 8-pole; gray	www.wago.com/286-112

Supus modificărilor.

















	Nr. articol: 286-113 Empty component plug housing; Type 12; 25 mm wide; 10-pole; gray	www.wago.com/286-113
	Nr. articol: 286-304 Relay module; Nominal input voltage: 24 VDC; 1 changeover contact; Limiting continuous current: 7 A; Red status indicator; Module width: 15 mm; gray	www.wago.com/286-304
	Nr. articol: 286-304/004-000 Relay module; Nominal input voltage: 24 VDC; 1 changeover contact; Limiting continuous current: 7 A; Path; Red status indicator; Module width: 15 mm; gray	www.wago.com/286-304/004-000
	Nr. articol: 286-307/004-000 Relay module; Nominal input voltage: 110 VDC; 1 changeover contact; Limiting continuous current: 7 A; Path; Red status indicator; Module width: 15 mm; gray	www.wago.com/286-307/004-000
	Nr. articol: 286-312 Relay module; Relay with 2 changeover contacts (2u); gray	www.wago.com/286-312
	Nr. articol: 286-312/004-000 Relay module; Nominal input voltage: 24 VDC; 2 changeover contacts; Limiting continuous current: 5 A; Path; Red status indicator; Module width: 20 mm; gray	www.wago.com/286-312/004-000
	Nr. articol: 286-316 Relay module; Nominal input voltage: 220 VDC; 2 changeover contacts; Limiting continuous current: 7 A; Red status indicator; Module width: 20 mm; gray	www.wago.com/286-316
	Nr. articol: 286-320 Relay module; Nominal input voltage: 24 VDC; 1 break and 1 make contact; Limiting continuous current: 6 A; Red status indicator; Module width: 20 mm; gray	www.wago.com/286-320
	Nr. articol: 286-320/004-000 Relay module; Nominal input voltage: 24 VDC; 1 break and 1 make contact; Path; Red status indicator; Module width: 20 mm; gray	www.wago.com/286-320/004-000
	Nr. articol: 286-328 Relay module; Nominal input voltage: 24 VDC; 2 make contact; Limiting continuous current: 6 A; Red status indicator; Module width: 20 mm; gray	www.wago.com/286-328
	Nr. articol: 286-328/004-000 Relay module; Nominal input voltage: 24 VDC; 2 make contact; Limiting continuous current: 6 A; Path; Red status indicator; Module width: 20 mm; gray	www.wago.com/286-328/004-000
	Nr. articol: 286-336/001-000 Relay module; Nominal input voltage: 24 VDC; 2 break and 2 make contacts; Red status indicator; Module width: 25 mm; gray	www.wago.com/286-336/001-000
	Nr. articol: 286-344/004-000 Relay module; Nominal input voltage: 24 VDC; 3 break contacts and 1 make contact; Path; Red status indicator; Module width: 25 mm; gray	www.wago.com/286-344/004-000
	Nr. articol: 286-352/004-000 Relay module; Nominal input voltage: 24 VDC; 4 make contacts; Limiting continuous current: 5 A; Path; Red status indicator; Module width: 25 mm; gray	www.wago.com/286-352/004-000

















Supus modificărilor.

	Nr. articol: 286-364 Relay module; Nominal input voltage: 24 VDC; 1 make contact; Limiting continuous current: 5 A; Red status indicator; Module width: 10 mm; gray	www.wago.com/286-364
	Nr. articol: 286-364/004-000 Relay module; Nominal input voltage: 24 VDC; 1 make contact; Path; Red status indicator; Module width: 10 mm; gray	www.wago.com/286-364/004-000
	Nr. articol: 286-368 Relay module; Nominal input voltage: 24 VDC; 1 break contact; Limiting continuous current: 5 A; Red status indicator; Module width: 10 mm; gray	www.wago.com/286-368
	Nr. articol: 286-368/004-000 Relay module; Nominal input voltage: 24 VDC; 1 break contact; Path; Red status indicator; Module width: 10 mm	www.wago.com/286-368/004-000
	Nr. articol: 286-376 Relay module; Nominal input voltage: 24 VDC; 1 make contact; Limiting continuous current: 5 A; for switching higher DC loads; Red status indicator; Module width: 15 mm; gray	www.wago.com/286-376
	Nr. articol: 286-380 Bistable relay module; Nominal input voltage: 24 VDC; 1 changeover contact; Limiting continuous current: 6 A; Red status indicator; Module width: 15 mm; gray	www.wago.com/286-380
	Nr. articol: 286-381 Bistable relay module; Nominal input voltage: 24 VDC; 1 changeover contact; Limiting continuous current: 6 A; Red status indicator; Module width: 15 mm; gray	www.wago.com/286-381
	Nr. articol: 286-394/004-000 Relay module; Nominal input voltage: 24 VDC; 1 changeover contact; Path; Red status indicator; Module width: 15 mm; light gray	www.wago.com/286-394/004-000
	Nr. articol: 286-427 Timer relay module; Nominal input voltage: 24 VDC; Limiting continuous current: 5 A; Pulse lengthening: 1 ... 10 s; Red status indicator; Module width: 20 mm; gray	www.wago.com/286-427
	Nr. articol: 286-507 Relay module; Nominal input voltage: 115 VAC; 1 changeover contact; Limiting continuous current: 7 A; Red status indicator; Module width: 15 mm; gray	www.wago.com/286-507
	Nr. articol: 286-508 Relay module; Nominal input voltage: 230 VAC; 1 changeover contact; Limiting continuous current: 7 A; Red status indicator; Module width: 15 mm; gray	www.wago.com/286-508
	Nr. articol: 286-516 Relay module; Nominal input voltage: 230 VAC; 2 changeover contacts; Limiting continuous current: 7 A; Red status indicator; Module width: 15 mm; gray	www.wago.com/286-516
	Nr. articol: 286-573 Latching relay module; Nominal input voltage: 24 VDC; 1 changeover contact; Limiting continuous current: 6 A; Red status indicator; Module width: 15 mm	www.wago.com/286-573
	Nr. articol: 286-575 Latching relay module; Nominal input voltage: 24 VDC; 1 changeover contact; Limiting continuous current: 3 A; Path; Red status indicator; Module width: 22 mm	www.wago.com/286-575
	Nr. articol: 286-604/004-000 Timer relay module; Nominal input voltage: 24 VDC; Limiting continuous current: 6 A; On-delay: 10 ... 100 s; Red status indicator; Module width: 20 mm; gray	www.wago.com/286-604/004-000

Supus modificărilor.

	Nr. articol: 286-640 Timer relay module; Nominal input voltage: 24 VDC; Limiting continuous current: 6 A; Path; Multifunction/Multitime; Yellow status indicator; Module width: 6 mm; gray	www.wago.com/286-640
	Nr. articol: 286-640/004-000 Multifunction timing relay module; Relay with 1 changeover contact (1u); 4 time ranges; for railway operations; 4 functions; gray	www.wago.com/286-640/004-000
	Nr. articol: 286-661 Current flow monitoring module; AC currents; adjustable; light gray	www.wago.com/286-661
	Nr. articol: 286-662 Current flow monitoring module; DC currents; Monitoring range: 0.4 A – 3.5 A; 1 make contact; light gray	www.wago.com/286-662
	Nr. articol: 286-664 Current flow monitoring module; AC currents; Monitoring range: 1 A – 10 A; 1 changeover contact; light gray	www.wago.com/286-664
	Nr. articol: 286-665 Current flow monitoring module; AC currents; Monitoring range: 1 A – 10 A; 1 changeover contact; light gray	www.wago.com/286-665
	Nr. articol: 286-721 Optocoupler module; Nominal input voltage: 24 VDC; Output voltage range: 15 ... 30 VDC; Limiting continuous current: 5 A; 3-wire connection/low-side switching; Red status indicator; Module width: 15 mm; gray	www.wago.com/286-721
	Nr. articol: 286-723 Optocoupler module; Nominal input voltage: 24 VDC; Output voltage range: 15 ... 30 VDC; Limiting continuous current: 4 A; 3-wire connection/high-side switching; Red status indicator; Module width: 15 mm; gray	www.wago.com/286-723
	Nr. articol: 286-725 Optocoupler module; Input AC/DC 10 V ... 30 V; Output DC 24 V/ 1 mA ... 0.5 A; negative switching; gray	www.wago.com/286-725
	Nr. articol: 286-742 S0 interface power supply; Input voltage: 230 VAC; S0 interface	www.wago.com/286-742
	Nr. articol: 286-752 Optocoupler module; Nominal input voltage: 24 VDC; Output voltage range: 20 ... 30 VDC; Limiting continuous current: 0.5 A; 3-wire connection/high-side switching; Frequency: 25 kHz; Red status indicator; Module width: 15 mm; gray	www.wago.com/286-752
	Nr. articol: 286-752/002-000 Optocoupler module; Red status indicator; gray	www.wago.com/286-752/002-000
	Nr. articol: 286-790 Optocoupler module; gray	www.wago.com/286-790
	Nr. articol: 286-791 Optocoupler module; Nominal input voltage: 24 VDC; Output voltage range: 20 ... 60 VDC; Limiting continuous current: 0.1 A; 2-wire connection; Frequency: 3 kHz; Red status indicator; Module width: 10 mm; gray	www.wago.com/286-791

Supus modificărilor.

	Nr. articol: 286-792 Optocoupler module; Red status indicator; gray	www.wago.com/286-792
	Nr. articol: 286-794 Optocoupler module; Nominal input voltage: 24 VDC; Output voltage range: 20 ... 60 VDC; Limiting continuous current: 0.1 A; 2-wire connection; Red status indicator; Module width: 10 mm; gray	www.wago.com/286-794
	Nr. articol: 286-797 Optocoupler module; Red status indicator	www.wago.com/286-797
	Nr. articol: 286-803 Component module with diode; gray	www.wago.com/286-803
	Nr. articol: 286-805 Component module with diode; light gray	www.wago.com/286-805
	Nr. articol: 286-807 Component module with diode; with 7 pcs; Diode 1N4007; with common anode; light gray	www.wago.com/286-807
	Nr. articol: 286-809 Component module with diode; light gray	www.wago.com/286-809
	Nr. articol: 286-822 Component module with LED; Red LED; with common cathode	www.wago.com/286-822
	Nr. articol: 286-826 AND gate module with 6 inputs; light gray	www.wago.com/286-826
	Nr. articol: 286-830 Bridge rectifier module; Input voltage: 24 VAC; with varistor protective circuit; gray	www.wago.com/286-830
	Nr. articol: 286-831 Surge suppression module for signal technology; Nominal voltage: 24 VAC/DC; for 2 signal paths with common surge arrester; plugged on rail-mount terminal block, 15 mm wide; gray	www.wago.com/286-831
	Nr. articol: 286-832 Surge suppression module for signal technology; Nominal voltage: 24 VAC/DC; for 2 signal paths with common surge arrester; pluggable on rail-mount terminal block, 20 mm wide; gray	www.wago.com/286-832
	Nr. articol: 286-833 Surge suppression module for signal technology; Nominal voltage: 24 VDC; for 1 signal path; plugged on rail-mount terminal block, 15 mm wide; gray	www.wago.com/286-833
	Nr. articol: 286-834 Surge suppression module for signal technology; Nominal voltage: 12 VDC; for 2 signal paths with common surge arrester; pluggable on rail-mount terminal block, 20 mm wide; gray	www.wago.com/286-834
	Nr. articol: 286-834/024-000 Surge suppression module for signal technology; Nominal voltage: 24 VDC; for 2 signal paths with common surge arrester; pluggable on rail-mount terminal block, 15 mm wide; gray	www.wago.com/286-834/024-000
	Nr. articol: 286-835 Surge suppression module for signal technology; Nominal voltage: 230 VAC; for 2 signal paths with common surge arrester; plugged on rail-mount terminal block, 15 mm wide	www.wago.com/286-835
	Nr. articol: 286-835/115-000 Surge suppression module for signal technology; Nominal voltage: 115 VAC; for 2 signal paths with	www.wago.com/286-835/115-000

Supus modificărilor.

common surge arrester; plugged on rail-mount terminal block, 15 mm wide; gray

**Nr. articol: 286-836**

Surge suppression module for signal technology; Nominal voltage: 24 VAC/DC; for 2 signal paths with common surge arrester; plugged on rail-mount terminal block, 15 mm wide; gray

www.wago.com/286-836

**Nr. articol: 286-838**

Surge suppression module for signal technology; Nominal voltage: 230 VAC; for 2 signal paths with common surge arrester; with visual indicator; gray

www.wago.com/286-838

**Nr. articol: 286-840**

Bridge rectifier module; Input voltage: 250 VAC; with varistor protective circuit; gray

www.wago.com/286-840

**Nr. articol: 286-841**

Surge suppression module for signal technology; Nominal voltage: 220 VDC; for 2 signal paths with common surge arrester; pluggable on rail-mount terminal block, 25 mm wide; gray

www.wago.com/286-841

**Nr. articol: 286-842**

Surge suppression module for signal technology; Nominal voltage: 230 VAC; for 2 signal paths with common surge arrester; pluggable on rail-mount terminal block, 25 mm wide; gray

www.wago.com/286-842

**Nr. articol: 286-843**

Surge suppression module for signal technology; Nominal voltage: 115 VAC; for 2 signal paths with common surge arrester; pluggable on rail-mount terminal block, 25 mm wide; gray

www.wago.com/286-843

**Nr. articol: 286-844**

Surge suppression module for signal technology; for 2 signal paths with common surge arrester; pluggable on rail-mount terminal block, 25 mm wide; gray

www.wago.com/286-844

**Nr. articol: 286-890**

Component module with fuse; for (5 x 20) mm microfuse; Nominal voltage: 24 VAC/DC; gray

www.wago.com/286-890

**Nr. articol: 286-891**

Component module with fuse; for (5 x 20) mm microfuse; Nominal voltage: 230 VAC/DC; gray

www.wago.com/286-891

**Nr. articol: 286-895**

Switching module; with changeover rocker switch; Switching voltage: 250 VAC; Switching current: 6 A; gray

www.wago.com/286-895

**Nr. articol: 286-896**

Switching module; with momentary switch; Switching voltage: 250 VAC; Switching current: 6 A; gray

www.wago.com/286-896

Marking accessories**Nr. articol: 2009-115**

WMB-Inline; for Smart Printer; 1500 pieces on roll; stretchable 5 - 5.2 mm; plain; snap-on type; white

www.wago.com/2009-115

**Nr. articol: 2009-115/000-002**

WMB-Inline; for Smart Printer; 1500 pieces on roll; stretchable 5 - 5.2 mm; plain; snap-on type; yellow

www.wago.com/2009-115/000-002

**Nr. articol: 2009-115/000-006**

WMB-Inline; for Smart Printer; 1500 pieces on roll; stretchable 5 - 5.2 mm; plain; snap-on type; blue

www.wago.com/2009-115/000-006

**Nr. articol: 2009-115/000-007**















WMB-Inline; for Smart Printer; 1500 pieces on roll; stretchable 5 - 5.2 mm; plain; snap-on type; gray

www.wago.com/2009-115/000-007

Supus modificărilor.

WAGO Kontakttechnik GmbH & Co. KG
/Representative Office Romania
Sos. Pipera-Tunari nr. 1/1
building 1, 2nd floor | 077190 Voluntari, Ilfov
Tel.: +40-(0)31 421 85 68 | Email: info-RO@wago.com

Aveți întrebări despre produsele noastre?
Vă stăm la dispoziție pentru preluarea apelului la +40 (0) 31 421 85 68.

	Nr. articol: 2009-115/000-012 WMB-Inline; for Smart Printer; 1500 pieces on roll; stretchable 5 - 5.2 mm; plain; snap-on type; orange /000-012	www.wago.com/2009-115/000-012
	Nr. articol: 2009-115/000-017 WMB-Inline; for Smart Printer; 1500 pieces on roll; stretchable 5 - 5.2 mm; plain; snap-on type; light green	www.wago.com/2009-115/000-017
	Nr. articol: 2009-115/000-023 WMB-Inline; for Smart Printer; 1500 pieces on roll; stretchable 5 - 5.2 mm; plain; snap-on type; green /000-023	www.wago.com/2009-115/000-023
	Nr. articol: 2009-115/000-024 WMB-Inline; for Smart Printer; 1500 pieces on roll; stretchable 5 - 5.2 mm; plain; snap-on type; violet /000-024	www.wago.com/2009-115/000-024
	Nr. articol: 793-501 WMB marking card; as card; not stretchable; plain; snap-on type; white	www.wago.com/793-501
	Nr. articol: 793-501/000-002 WMB marking card; as card; not stretchable; plain; snap-on type; yellow	www.wago.com/793-501/000-002
	Nr. articol: 793-501/000-005 WMB marking card; as card; not stretchable; plain; snap-on type; red	www.wago.com/793-501/000-005
	Nr. articol: 793-501/000-006 WMB marking card; as card; not stretchable; plain; snap-on type; blue	www.wago.com/793-501/000-006
	Nr. articol: 793-501/000-007 WMB marking card; as card; not stretchable; plain; snap-on type; gray	www.wago.com/793-501/000-007
	Nr. articol: 793-501/000-012 WMB marking card; as card; not stretchable; plain; snap-on type; orange	www.wago.com/793-501/000-012
	Nr. articol: 793-501/000-017 WMB marking card; as card; not stretchable; plain; snap-on type; light green	www.wago.com/793-501/000-017
	Nr. articol: 793-501/000-023 WMB marking card; as card; not stretchable; plain; snap-on type; green	www.wago.com/793-501/000-023
	Nr. articol: 793-501/000-024 WMB marking card; as card; not stretchable; plain; snap-on type; violet	www.wago.com/793-501/000-024
	Nr. articol: 793-5501 WMB marking card; as card; for terminal block width 5 - 17.5 mm; stretchable 5 - 5.2 mm; plain; snap-on type; white	www.wago.com/793-5501

Supus modificărilor.

**Nr. articol:** 793-5501/000-002

WMB marking card; as card; for terminal block width 5 - 17.5 mm; stretchable 5 - 5.2 mm; plain; snap-on type; yellow

www.wago.com/793-5501/000-002**Nr. articol:** 793-5501/000-005

WMB marking card; as card; for terminal block width 5 - 17.5 mm; stretchable 5 - 5.2 mm; plain; snap-on type; red

www.wago.com/793-5501/000-005**Nr. articol:** 793-5501/000-006

WMB marking card; as card; for terminal block width 5 - 17.5 mm; stretchable 5 - 5.2 mm; plain; snap-on type; blue

www.wago.com/793-5501/000-006**Nr. articol:** 793-5501/000-007

WMB marking card; as card; for terminal block width 5 - 17.5 mm; stretchable 5 - 5.2 mm; plain; snap-on type; gray

www.wago.com/793-5501/000-007**Nr. articol:** 793-5501/000-012

WMB marking card; as card; for terminal block width 5 - 17.5 mm; stretchable 5 - 5.2 mm; plain; snap-on type; orange

www.wago.com/793-5501/000-012**Nr. articol:** 793-5501/000-017

WMB marking card; as card; for terminal block width 5 - 17.5 mm; stretchable 5 - 5.2 mm; plain; snap-on type; green

www.wago.com/793-5501/000-017**Nr. articol:** 793-5501/000-023

WMB marking card; as card; for terminal block width 5 - 17.5 mm; stretchable 5 - 5.2 mm; plain; snap-on type; light green

www.wago.com/793-5501/000-023**Nr. articol:** 793-5501/000-024

WMB marking card; as card; for terminal block width 5 - 17.5 mm; stretchable 5 - 5.2 mm; plain; snap-on type; violet

www.wago.com/793-5501/000-024**Jumper****Nr. articol:** 210-103

Wire commoning chain; insulated; 50 connections; black

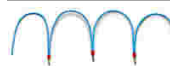
www.wago.com/210-103**Nr. articol:** 210-123

Wire commoning chain; insulated; 50 connections

www.wago.com/210-123**Nr. articol:** 280-482

Comb-style jumper bar; insulated; 2-way; IN = IN terminal block; gray

www.wago.com/280-482**Nr. articol:** 280-483

Comb-style jumper bar; insulated; 3-way; IN = IN terminal block; gray

www.wago.com/280-483**Nr. articol:** 280-484

Comb-style jumper bar; insulated; 4-way; IN = IN terminal block; gray

www.wago.com/280-484**Nr. articol:** 280-485

Comb-style jumper bar; insulated; 5-way; IN = IN terminal block; gray

www.wago.com/280-485**Nr. articol:** 280-490

Comb-style jumper bar; insulated; 10-way; IN = IN terminal block; gray

www.wago.com/280-490

Supus modificărilor.

	Nr. articol: 280-492 Alternate comb-style jumper bar; insulated; 2-way; IN = IN terminal block; gray	www.wago.com/280-492
--	--	--

	Nr. articol: 709-110 Wire commoning chain; insulated; 4 connections; 3 x 110 mm; black	www.wago.com/709-110
--	--	--

	Nr. articol: 709-111 Wire commoning chain; insulated; 3 connections; 2 x 120 mm; black	www.wago.com/709-111
--	--	--

	Nr. articol: 709-112 Wire commoning chain; insulated; 3 connections; 2 x 170 mm; black	www.wago.com/709-112
--	--	--

Insulation stop

	Nr. articol: 280-470 Insulation stop; 0.08 - 0.2 mm ² "s" (0.14 mm ² "f-st"); 5 pieces/strip; white	www.wago.com/280-470
--	---	--

	Nr. articol: 280-471 Insulation stop; 0.25 - 0.5 mm ² ; 5 pieces/strip; light gray	www.wago.com/280-471
--	---	--

	Nr. articol: 280-472 Insulation stop; 0.75 - 1 mm ² ; 5 pieces/strip	www.wago.com/280-472
--	---	--

assembling

	Nr. articol: 209-106 Mounting carrier; for isolated mounting on DIN 35 rails; gray	www.wago.com/209-106
--	--	--

	Nr. articol: 210-148 Angled support bracket; without screw	www.wago.com/210-148
---	--	--

ferrule

	Nr. articol: 216-101 Ferrule; Sleeve for 0.5 mm ² / AWG 22; uninsulated; electro-tin plated	www.wago.com/216-101
---	--	--

	Nr. articol: 216-102 Ferrule; Sleeve for 0.75 mm ² / AWG 20; uninsulated; electro-tin plated	www.wago.com/216-102
---	---	--

	Nr. articol: 216-103 Ferrule; Sleeve for 1 mm ² / AWG 18; uninsulated; electro-tin plated	www.wago.com/216-103
---	--	--

	Nr. articol: 216-104 Ferrule; Sleeve for 1.5 mm ² / AWG 16; uninsulated; electro-tin plated	www.wago.com/216-104
---	--	--













	Nr. articol: 216-201 Ferrule; Sleeve for 0.5 mm ² / 20 AWG; insulated; electro-tin plated; white	www.wago.com/216-201
---	---	--

	Nr. articol: 216-202 Ferrule; Sleeve for 0.75 mm ² / 18 AWG; insulated; electro-tin plated; gray	www.wago.com/216-202
---	---	--









	Nr. articol: 216-203 Ferrule; Sleeve for 1 mm ² / AWG 18; insulated; electro-tin plated; red	www.wago.com/216-203
---	---	--

	Nr. articol: 216-204 Ferrule; Sleeve for 1.5 mm ² / AWG 16; insulated; electro-tin plated; black	www.wago.com/216-204
---	---	--

Supus modificărilor.

	Nr. articol: 216-301 Ferrule; Sleeve for 0.25 mm ² / AWG 24; insulated; electro-tin plated; yellow	www.wago.com/216-301
	Nr. articol: 216-302 Ferrule; Sleeve for 0.34 mm ² / 22 AWG; insulated; electro-tin plated; green	www.wago.com/216-302
plug		
	Nr. articol: 280-801 Empty component plug housing; gray	www.wago.com/280-801
	Nr. articol: 280-801/281-411 Component plug; for carrier terminal blocks; 2-pole; with diode 1N4007; 5 mm wide; gray	www.wago.com/280-801/281-411
	Nr. articol: 280-801/281-413 Component plug; for carrier terminal blocks; 1-pole; LED (red); 24 VDC; 5 mm wide; gray	www.wago.com/280-801/281-413
	Nr. articol: 280-801/281-414 Component plug; for carrier terminal blocks; 1-pole; LED (red); 48 VDC; 5 mm wide; gray	www.wago.com/280-801/281-414
	Nr. articol: 280-801/281-415 Component plug; for carrier terminal blocks; 1-pole; LED (red); 5 mm wide; gray	www.wago.com/280-801/281-415
	Nr. articol: 280-801/281-416 Component plug; for carrier terminal blocks; 1-pole; LED (red); 5 mm wide; gray	www.wago.com/280-801/281-416
	Nr. articol: 280-801/281-417 Component plug; for carrier terminal blocks; 1-pole; 5 mm wide; gray	www.wago.com/280-801/281-417
	Nr. articol: 280-801/281-418 Component plug; for carrier terminal blocks; 1-pole; 5 mm wide; gray	www.wago.com/280-801/281-418
	Nr. articol: 280-801/281-420 Component plug; for carrier terminal blocks; 2-pole; with LED and recovery diode; 5 mm wide; gray	www.wago.com/280-801/281-420
	Nr. articol: 280-801/281-421 Component plug; for carrier terminal blocks; 2-pole; with LED and recovery diode; 5 mm wide; gray	www.wago.com/280-801/281-421
	Nr. articol: 280-850 Fuse plug; with soldered miniature fuse; 250 mA FF; 5 mm wide; gray	www.wago.com/280-850
	Nr. articol: 280-850/281-413 Fuse plug; with soldered miniature fuse; with indicator lamp; LED (red); DC 15 - 30 V; 250 mA FF; 5 mm wide; gray	www.wago.com/280-850/281-413

Supus modificărilor.

	Nr. articol: 280-850/281-414 Fuse plug; with soldered miniature fuse; with indicator lamp; LED (red); DC 30 - 65 V; 250 mA FF; 5 mm wide; gray	www.wago.com/280-850/281-414
	Nr. articol: 280-850/281-415 Fuse plug; with soldered miniature fuse; with indicator lamp; LED (red); AC 15 - 30 V; 250 mA FF; 5 mm wide; gray	www.wago.com/280-850/281-415
	Nr. articol: 280-852 Fuse plug; with soldered miniature fuse; 500 mA FF; 5 mm wide; gray	www.wago.com/280-852
	Nr. articol: 280-852/281-413 Fuse plug; with soldered miniature fuse; with indicator lamp; LED (red); DC 15 - 30 V; 500 mA FF; 5 mm wide; gray	www.wago.com/280-852/281-413
	Nr. articol: 280-852/281-414 Fuse plug; with soldered miniature fuse; with indicator lamp; LED (red); DC 30 - 65 V; 500 mA FF; 5 mm wide; gray	www.wago.com/280-852/281-414
	Nr. articol: 280-852/281-415 Fuse plug; with soldered miniature fuse; with indicator lamp; LED (red); AC 15 - 30 V; 500 mA FF; 5 mm wide; gray	www.wago.com/280-852/281-415
	Nr. articol: 280-854 Fuse plug; with soldered miniature fuse; 1 A FF; 5 mm wide; gray	www.wago.com/280-854
	Nr. articol: 280-854/281-413 Fuse plug; with soldered miniature fuse; with indicator lamp; LED (red); DC 15 - 30 V; 1 A FF; 5 mm wide; gray	www.wago.com/280-854/281-413
	Nr. articol: 280-854/281-414 Fuse plug; with soldered miniature fuse; with indicator lamp; LED (red); DC 30 - 65 V; 1 A FF; 5 mm wide; gray	www.wago.com/280-854/281-414
	Nr. articol: 280-854/281-415 Fuse plug; with soldered miniature fuse; with indicator lamp; LED (red); AC 15 - 30 V; 1 A FF; 5 mm wide; gray	www.wago.com/280-854/281-415
	Nr. articol: 280-856 Fuse plug; with soldered miniature fuse; 2 A FF; 5 mm wide; gray	www.wago.com/280-856
	Nr. articol: 280-856/281-413 Fuse plug; with soldered miniature fuse; with indicator lamp; LED (red); DC 15 - 30 V; 2 A FF; 5 mm wide; gray	www.wago.com/280-856/281-413
	Nr. articol: 280-856/281-414 Fuse plug; with soldered miniature fuse; with indicator lamp; LED (red); DC 30 - 65 V; 2 A FF; 5 mm wide; gray	www.wago.com/280-856/281-414
	Nr. articol: 280-856/281-415 Fuse plug; with soldered miniature fuse; with indicator lamp; LED (red); AC 15 - 30 V; 2 A FF; 5 mm wide; gray	www.wago.com/280-856/281-415

End plate

Supus modificărilor.

WAGO Kontakttechnik GmbH & Co. KG
/Representative Office Romania
Sos. Pipera-Tunari nr. 1/1
building 1, 2nd floor | 077190 Voluntari, Ilfov
Tel.: +40-(0)31 421 85 68 | Email: info-RO@wago.com

Aveți întrebări despre produsele noastre?
Vă stăm la dispoziție pentru preluarea apelului la +40 (0) 31 421 85 68.



Nr. articol: 280-324

End and intermediate plate; 2.5 mm thick; gray

www.wago.com/280-324



Nr. articol: 280-326

End and intermediate plate; 2.5 mm thick; orange

www.wago.com/280-326

Descărcări

Documentation

Additional Information

Technical explanations

Apr 3, 2019

pdf
2,1 MB

Descărcare

CAD/CAE-Data

CAD data

2D/3D Models 280-610

URL

Descărcare

CAE data

EPLAN Data Portal 280-610

URL

Descărcare

WSCAD Universe 280-610

URL

Descărcare

Installation Notes

Supus modificărilor.