

Fișă tehnică | Număr articol: 2004-404

Push-in type jumper bar; insulated; 4-way; Nominal current 32 A; light gray

www.wago.com/2004-404

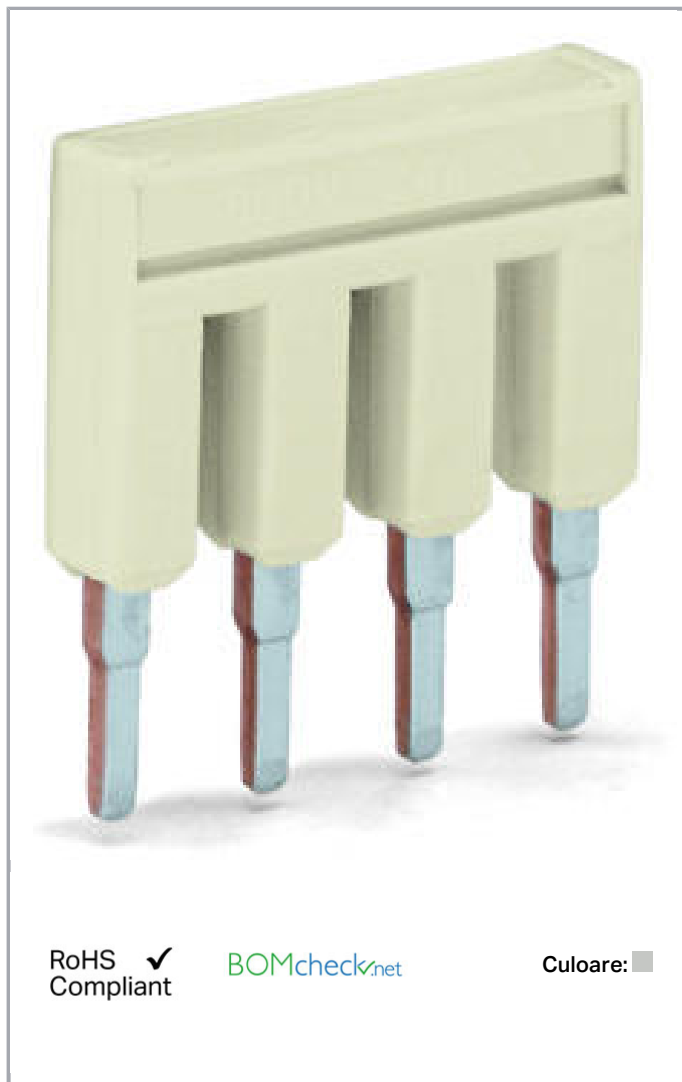

RoHS
Compliant

[BOMcheck.net](https://www.bomcheck.net)

Culoare:

Date

Electrical data

Ratings per IEC/EN 60664-1

Nominal voltage (III/3)	800 V
Rated current	32 A

Supus modificărilor.

WAGO Kontakttechnik GmbH & Co. KG
/Representative Office Romania
Sos. Pipera-Tunari nr. 1/1
building 1, 2nd floor | 077190 Voluntari, Ilfov
Tel.: +40-(0)31 421 85 68 | Email: info-RO@wago.com

Aveți întrebări despre produsele noastre?
Vă stăm la dispoziție pentru preluarea apelului la +40 (0) 31 421 85 68.



Approvals Ex

Rated current (Ex e II)	30 A
-------------------------	------

Geometrical Data

Width	22,8 mm / 0.898 inch
Height	19 mm / 0.748 inch
Depth	4,1 mm / 0.161 inch

Material Data

Color	light gray
Fire load	0,015 MJ
Weight	3,1 g

Commercial data

Product Group	22 (TOPJOB S)
Packaging type	bag
Country of origin	DE
GTIN	4055143699846
Customs tariff number	85366990990

Counterpart

Descărcări

Documentation

Additional Information

Technical explanations	Apr 3, 2019	pdf 2,1 MB	Descărcare
------------------------	-------------	---------------	------------

CAD/CAE-Data

CAD data

2D/3D Models 2004-404	URL	Descărcare
-----------------------	-----	------------

CAE data

EPLAN Data Portal 2004-404	URL	Descărcare
----------------------------	-----	------------

Supus modificărilor.

Installation Notes

Jumpered

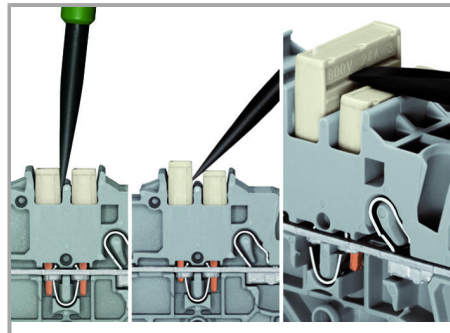
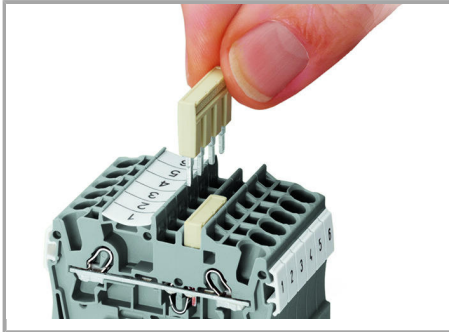

The push-in type jumper bar system is based on the common plug and socket principle. Each terminal block is spring-loaded with a double socket and a resilient CrNi steel spring. The jumper contact material is pure electrolytic copper, which allows for an extremely small design capable of carrying the full-rated current of the terminal block. Ground terminal blocks can also be commoned using the same jumper system. Custom jumpers are created by breaking and removing jumper contacts (2000, 2001, 2002, 2004 Series).

Removing a push-in type jumper bar.

Insert the operating tool between the jumper and the partition wall of the dual jumper slots, then lift up the jumper.

Place the operating tool in the center of jumpers up to five contacts (see above), or alternately on both sides for jumpers with more than five contacts.

Jumpered

Supus modificărilor.



Custom push-in type jumper bars are created by breaking off jumper contacts.



Marking a push-in type jumper bar using a felt-tip pen.

500 V

300 V

Jumpered



Stepping down via push-in type jumper bar.



Stepping down via push-in type jumper bar.

Commoning via closed terminal side with end plate allows jumpering over two cross-section sizes, e.g., from 16 mm² (6 AWG) to 6 mm² (10 AWG) or from 6 mm² (10 AWG) to 2.5 mm² (14 AWG) (see illustration above).

Familie de produse

Supus modificărilor.

WAGO Kontakttechnik GmbH & Co. KG
/Representative Office Romania
Sos. Pipera-Tunari nr. 1/1
building 1, 2nd floor | 077190 Voluntari, Ilfov
Tel.: +40-(0)31 421 85 68 | Email: info-RO@wago.com

Aveți întrebări despre produsele noastre?
Vă stăm la dispoziție pentru preluarea apelului la +40 (0) 31 421 85 68.



TOPJOB® S

TOPJOB® S: In various industrial applications and modern building installations, WAGO's wide and versatile range of rail-mount terminal blocks provides more than just reliable electrical connections.

Afișare globală produse din familie.

Supus modificărilor.

WAGO Kontakttechnik GmbH & Co. KG
/Representative Office Romania
Sos. Pipera-Tunari nr. 1/1
building 1, 2nd floor | 077190 Voluntari, Ilfov
Tel.: +40-(0)31 421 85 68 | Email: info-RO@wago.com

Aveți întrebări despre produsele noastre?
Vă stăm la dispoziție pentru preluarea apelului la +40 (0) 31 421 85 68.