

## Fișă tehnică | Număr articol: 769-602/002-000

1-conductor male connector; clamping collar; 4 mm<sup>2</sup>; Pin spacing 5 mm; 2-pole; 4,00 mm<sup>2</sup>; gray

[www.wago.com/769-602/002-000](http://www.wago.com/769-602/002-000)



RoHS  Compliant

BOMcheck.net

Culoare: ■

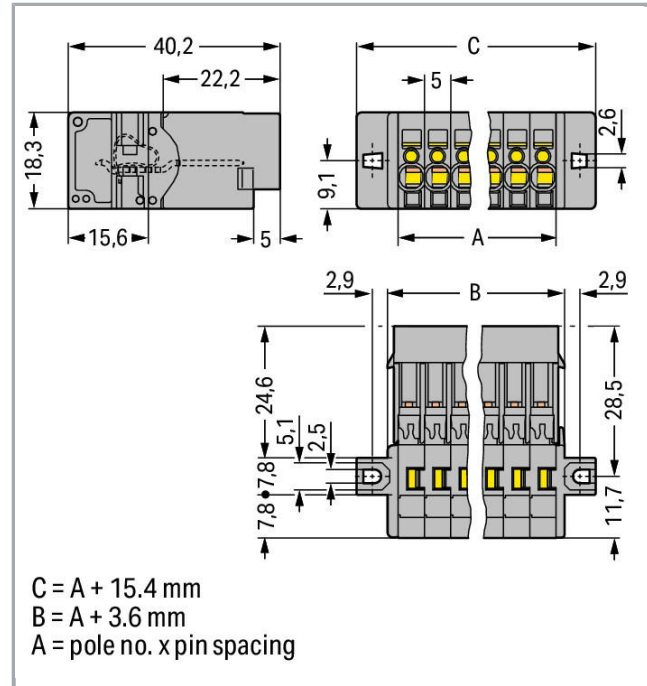

### Date

### Electrical data

### Ratings per IEC/EN 60664-1

|                             |   |
|-----------------------------|---|
| Nominal voltage (III/3)     | 500 V   |
| Rated surge voltage (III/3) | 6 kV  |
| Rated current               | 32 A  |
| Legend (ratings)            | (III / 3) ≙ Overvoltage category III / Pollution degree 3 |

### Connection data

|                                 |                |
|---------------------------------|----------------|
| Connection technology           | CAGE CLAMP®    |
| Actuation type                  | Operating tool |
| Connectable conductor materials | Copper         |

Supus modificărilor.

WAGO Kontakttechnik GmbH & Co. KG  
/Representative Office Romania  
Sos. Pipera-Tunari nr. 1/1  
building 1, 2nd floor | 077190 Voluntari, Ilfov  
Tel.: +40-(0)31 421 85 68 | Email: info-RO@wago.com

Aveți întrebări despre produsele noastre?  
Vă stăm la dispoziție pentru preluarea apelului la +40 (0) 31 421 85 68.



|                                   |  |
|-----------------------------------|--|
| Nominal cross-section             | 4 mm <sup>2</sup>                          |
| Solid conductor                   | 0,08 ... 4 mm <sup>2</sup> / 28 ... 12 AWG |
| Fine-stranded conductor           | 0,08 ... 4 mm <sup>2</sup> / 28 ... 12 AWG |
| Strip length                      | 8 ... 9 mm / 0.31 ... 0.35 inch            |
| Pole No.                          | 2  |
| Total number of connection points | 2  |
| Total number of potentials        | 2  |
| Wiring type                       | Front-entry wiring                         |

**Geometrical Data**

|                         |                      |
|-------------------------|----------------------|
| Pin spacing             | 5 mm / 0.197 inch    |
| Width                   | 25,4 mm / 1 inch     |
| Height from the surface | 18,3 mm / 0.72 inch  |
| Depth                   | 40,2 mm / 1.583 inch |

**Mechanical data**

|               |                 |
|---------------|-----------------|
| Mounting type | Mounting flange |
|---------------|-----------------|

**Plug connection**

|                                    |                     |
|------------------------------------|---------------------|
| Contact type (pluggable connector) | Male connector/plug |
| Connector (connection type)        | for conductors      |

**Material Data**

|                     |                      |
|---------------------|----------------------|
| Color               | gray                 |
| Insulation material | Polyamide 66 (PA 66) |
| Fire load           | 0,177 MJ             |
| Weight              | 7,9 g                |

**Commercial data**

|                       |                   |
|-----------------------|-------------------|
| Product Group         | 18 (X-COM-System) |
| Packaging type        | BOX               |
| Country of origin     | PL                |
| GTIN                  | 4044918520690     |
| Customs tariff number | 85366990990       |





Supus modificărilor.

WAGO Kontakttechnik GmbH & Co. KG  
 /Representative Office Romania  
 Sos. Pipera-Tunari nr. 1/1  
 building 1, 2nd floor | 077190 Voluntari, Ilfov  
 Tel.: +40-(0)31 421 85 68 | Email: info-RO@wago.com

Aveți întrebări despre produsele noastre?  
 Vă stăm la dispoziție pentru preluarea apelului la +40 (0) 31 421 85 68.

## Aprobări / certificate



## Country specific Approvals

| Emblemă  | Aprobare                              | Text de aprobare suplimentar | Nume certificat |
|--|---------------------------------------|------------------------------|-----------------|
|  | CCA<br>DEKRA Certification B.V.       | EN 60947                     | NTR NL-7626     |
|  | CCA<br>DEKRA Certification B.V.       | EN 61984                     | 2190419.02      |
|  | CSA<br>DEKRA Certification B.V.       | C22.2 No. 158                | 1101144         |
|  | KEMA/KEUR<br>DEKRA Certification B.V. | EN 60947                     | 2190419.01      |

## Ship Approvals

| Emblemă  | Aprobare   | Text de aprobare suplimentar | Nume certificat |
|--|--|------------------------------|-----------------|
|  | DNV GL<br>Det Norske Veritas, Germanischer Lloyd | -                            | TAE00001V2      |

## UL-Approvals



| Emblemă  | Aprobare                             | Text de aprobare suplimentar | Nume certificat |
|--|--------------------------------------|------------------------------|-----------------|
|  | UR<br>Underwriters Laboratories Inc. | UL 1977                      | 20151210-E45171 |
|  | UR<br>Underwriters Laboratories Inc. | UL 1059                      | 20190731-E45172 |

Supus modificărilor.







## Counterpart

## Produse compatibile

## Insulation stop

|  |   |  |
|--|---|--|
|  | <b>Nr. articol: 769-470</b><br>Insulation stop; 0.08 - 0.2 mm <sup>2</sup> "s" (0.14 mm <sup>2</sup> "f-st"); 5 pieces/strip; white | <a href="http://www.wago.com/769-470">www.wago.com/769-470</a> |
|  | <b>Nr. articol: 769-471</b><br>Insulation stop; 0.25 - 0.5 mm <sup>2</sup> ; 5 pieces/strip; light gray                             | <a href="http://www.wago.com/769-471">www.wago.com/769-471</a> |
|  | <b>Nr. articol: 769-472</b><br>Insulation stop; 0.75 - 1 mm <sup>2</sup> ; 5 pieces/strip; dark gray                                | <a href="http://www.wago.com/769-472">www.wago.com/769-472</a> |













## Marking accessories

|  |  |  |
|--|--|--|
|   | <b>Nr. articol: 2009-145</b><br>Mini-WSB Inline; for Smart Printer; 1700 pieces on roll; stretchable 5 - 5.2 mm; plain; snap-on type; white          | <a href="http://www.wago.com/2009-145">www.wago.com/2009-145</a>                 |
|  | <b>Nr. articol: 2009-145/000-002</b><br>Mini-WSB Inline; for Smart Printer; 1700 pieces on roll; stretchable 5 - 5.2 mm; plain; snap-on type; yellow | <a href="http://www.wago.com/2009-145/000-002">www.wago.com/2009-145/000-002</a> |
|  | <b>Nr. articol: 2009-145/000-005</b><br>Mini-WSB Inline; for Smart Printer; 1700 pieces on roll; stretchable 5 - 5.2 mm; plain; snap-on type; red    | <a href="http://www.wago.com/2009-145/000-005">www.wago.com/2009-145/000-005</a> |
|  | <b>Nr. articol: 2009-145/000-006</b><br>Mini-WSB Inline; for Smart Printer; 1700 pieces on roll; stretchable 5 - 5.2 mm; plain; snap-on type; blue   | <a href="http://www.wago.com/2009-145/000-006">www.wago.com/2009-145/000-006</a> |
|  | <b>Nr. articol: 2009-145/000-007</b><br>Mini-WSB Inline; for Smart Printer; 1700 pieces on roll; stretchable 5 - 5.2 mm; plain; snap-on type; gray   | <a href="http://www.wago.com/2009-145/000-007">www.wago.com/2009-145/000-007</a> |
|  | <b>Nr. articol: 2009-145/000-012</b><br>Mini-WSB Inline; for Smart Printer; 1700 pieces on roll; stretchable 5 - 5.2 mm; plain; snap-on type; orange | <a href="http://www.wago.com/2009-145/000-012">www.wago.com/2009-145/000-012</a> |
|  | <b>Nr. articol: 2009-145/000-023</b><br>Mini-WSB Inline; for Smart Printer; 1700 pieces on roll; stretchable 5 - 5.2 mm; plain; snap-on type; green  | <a href="http://www.wago.com/2009-145/000-023">www.wago.com/2009-145/000-023</a> |

Supus modificărilor.

WAGO Kontakttechnik GmbH & Co. KG  
/Representative Office Romania  
Sos. Pipera-Tunari nr. 1/1  
building 1, 2nd floor | 077190 Voluntari, Ilfov  
Tel.: +40-(0)31 421 85 68 | Email: info-RO@wago.com

Aveți întrebări despre produsele noastre?  
Vă stăm la dispoziție pentru preluarea apelului la +40 (0) 31 421 85 68.

|  |  |  |
|--|--|--|
|    | <b>Nr. articol: 2009-145/000-024</b><br>Mini-WSB Inline; for Smart Printer; 1700 pieces on roll; stretchable 5 - 5.2 mm; plain; snap-on type; violet | <a href="http://www.wago.com/2009-145/000-024">www.wago.com/2009-145/000-024</a> |
|    | <b>Nr. articol: 210-831</b><br>Marking strips; on reel; 2.3 mm wide; plain; Self-adhesive; white   | <a href="http://www.wago.com/210-831">www.wago.com/210-831</a>                   |
|    | <b>Nr. articol: 210-832</b><br>Marking strips; on reel; 3 mm wide; plain; Self-adhesive; white   | <a href="http://www.wago.com/210-832">www.wago.com/210-832</a>                   |
|  | <b>Nr. articol: 210-833</b><br>Marking strips; on reel; 6 mm wide; plain; Self-adhesive; white   | <a href="http://www.wago.com/210-833">www.wago.com/210-833</a>                   |
|    | <b>Nr. articol: 210-834</b><br>Marking strips; on reel; 5 mm wide; plain; Self-adhesive; white   | <a href="http://www.wago.com/210-834">www.wago.com/210-834</a>                   |
|    | <b>Nr. articol: 248-501</b><br>Miniature WSB Quick marking system; plain; Marker width 5 mm; 10 strips with 10 markers per card                      | <a href="http://www.wago.com/248-501">www.wago.com/248-501</a>                   |
|    | <b>Nr. articol: 248-501/000-002</b><br>Mini-WSB marking card; as card; not stretchable; plain; snap-on type; yellow                                  | <a href="http://www.wago.com/248-501/000-002">www.wago.com/248-501/000-002</a>   |
|    | <b>Nr. articol: 248-501/000-005</b><br>Mini-WSB marking card; as card; not stretchable; plain; snap-on type; red                                     | <a href="http://www.wago.com/248-501/000-005">www.wago.com/248-501/000-005</a>   |
|   | <b>Nr. articol: 248-501/000-006</b><br>Mini-WSB marking card; as card; not stretchable; plain; snap-on type; blue                                    | <a href="http://www.wago.com/248-501/000-006">www.wago.com/248-501/000-006</a>   |
|  | <b>Nr. articol: 248-501/000-007</b><br>Mini-WSB marking card; as card; not stretchable; plain; snap-on type; gray                                    | <a href="http://www.wago.com/248-501/000-007">www.wago.com/248-501/000-007</a>   |
|  | <b>Nr. articol: 248-501/000-012</b><br>Mini-WSB marking card; as card; not stretchable; plain; snap-on type; orange                                  | <a href="http://www.wago.com/248-501/000-012">www.wago.com/248-501/000-012</a>   |
|  | <b>Nr. articol: 248-501/000-017</b><br>Mini-WSB marking card; as card; not stretchable; plain; snap-on type; light green                             | <a href="http://www.wago.com/248-501/000-017">www.wago.com/248-501/000-017</a>   |
|  | <b>Nr. articol: 248-501/000-023</b><br>Mini-WSB marking card; as card; not stretchable; plain; snap-on type; green                                   | <a href="http://www.wago.com/248-501/000-023">www.wago.com/248-501/000-023</a>   |
|  | <b>Nr. articol: 248-501/000-024</b><br>Mini-WSB marking card; as card; not stretchable; plain; snap-on type; violet                                  | <a href="http://www.wago.com/248-501/000-024">www.wago.com/248-501/000-024</a>   |

**Protective Warning Marker**

|  |  |  |
|--|--|--|
|  | <b>Nr. articol: 280-415</b><br>Protective warning marker; with high-voltage symbol, black; for 5 terminal blocks; yellow | <a href="http://www.wago.com/280-415">www.wago.com/280-415</a> |
|--|--|--|

Supus modificărilor.







## Strain relief plate

|  |  |  |
|--|--|--|
|  | <b>Nr. articol: 769-410</b><br>Strain relief plate; gray | <a href="http://www.wago.com/769-410">www.wago.com/769-410</a> |
|  | <b>Nr. articol: 769-411</b><br>Strain relief plate; gray | <a href="http://www.wago.com/769-411">www.wago.com/769-411</a> |









## Female plug

|  |  |  |
|--|--|--|
|    | <b>Nr. articol: 769-101</b><br>1-conductor female plug; 4 mm <sup>2</sup> ; 1-pole; 4,00 mm <sup>2</sup> ; gray                        | <a href="http://www.wago.com/769-101">www.wago.com/769-101</a>                 |
|    | <b>Nr. articol: 769-101/000-016</b><br>1-conductor female plug; 4 mm <sup>2</sup> ; 1-pole; 4,00 mm <sup>2</sup> ; green-yellow        | <a href="http://www.wago.com/769-101/000-016">www.wago.com/769-101/000-016</a> |
|    | <b>Nr. articol: 769-102</b><br>1-conductor female plug; 4 mm <sup>2</sup> ; 2-pole; 4,00 mm <sup>2</sup> ; gray                        | <a href="http://www.wago.com/769-102">www.wago.com/769-102</a>                 |
|    | <b>Nr. articol: 769-102/000-036</b><br>1-conductor female plug; 4 mm <sup>2</sup> ; 2-pole; 4,00 mm <sup>2</sup> ; gray, green-yellow  | <a href="http://www.wago.com/769-102/000-036">www.wago.com/769-102/000-036</a> |
|   | <b>Nr. articol: 769-102/000-037</b><br>1-conductor female plug; 4 mm <sup>2</sup> ; 2-pole; 4,00 mm <sup>2</sup> ; green-yellow, gray  | <a href="http://www.wago.com/769-102/000-037">www.wago.com/769-102/000-037</a> |
|  | <b>Nr. articol: 769-102/021-000</b><br>1-conductor female plug; Locking lever; 4 mm <sup>2</sup> ; 2-pole; 4,00 mm <sup>2</sup> ; gray | <a href="http://www.wago.com/769-102/021-000">www.wago.com/769-102/021-000</a> |
|  | <b>Nr. articol: 769-121</b><br>2-conductor female connector; 4 mm <sup>2</sup> ; 1-pole; 4,00 mm <sup>2</sup> ; gray                   | <a href="http://www.wago.com/769-121">www.wago.com/769-121</a>                 |
|  | <b>Nr. articol: 769-122</b><br>2-conductor female connector; 4 mm <sup>2</sup> ; 2-pole; 4,00 mm <sup>2</sup> ; gray                   | <a href="http://www.wago.com/769-122">www.wago.com/769-122</a>                 |

## ferrule

|  |   |  |
|--|---|--|
|  | <b>Nr. articol: 216-101</b><br>Ferrule; Sleeve for 0.5 mm <sup>2</sup> / AWG 22; uninsulated; electro-tin plated  | <a href="http://www.wago.com/216-101">www.wago.com/216-101</a> |
|  | <b>Nr. articol: 216-102</b><br>Ferrule; Sleeve for 0.75 mm <sup>2</sup> / AWG 20; uninsulated; electro-tin plated | <a href="http://www.wago.com/216-102">www.wago.com/216-102</a> |
|  | <b>Nr. articol: 216-103</b><br>Ferrule; Sleeve for 1 mm <sup>2</sup> / AWG 18; uninsulated; electro-tin plated    | <a href="http://www.wago.com/216-103">www.wago.com/216-103</a> |
|  | <b>Nr. articol: 216-104</b><br>Ferrule; Sleeve for 1.5 mm <sup>2</sup> / AWG 16; uninsulated; electro-tin plated  | <a href="http://www.wago.com/216-104">www.wago.com/216-104</a> |

Supus modificărilor.

|  |  |  |
|--|--|--|
|    | <b>Nr. articol: 216-201</b><br>Ferrule; Sleeve for 0.5 mm <sup>2</sup> / 20 AWG; insulated; electro-tin plated; white        | <a href="http://www.wago.com/216-201">www.wago.com/216-201</a> |
|    | <b>Nr. articol: 216-202</b><br>Ferrule; Sleeve for 0.75 mm <sup>2</sup> / 18 AWG; insulated; electro-tin plated; gray        | <a href="http://www.wago.com/216-202">www.wago.com/216-202</a> |
|    | <b>Nr. articol: 216-203</b><br>Ferrule; Sleeve for 1 mm <sup>2</sup> / AWG 18; insulated; electro-tin plated; red            | <a href="http://www.wago.com/216-203">www.wago.com/216-203</a> |
|    | <b>Nr. articol: 216-204</b><br>Ferrule; Sleeve for 1.5 mm <sup>2</sup> / AWG 16; insulated; electro-tin plated; black        | <a href="http://www.wago.com/216-204">www.wago.com/216-204</a> |
|    | <b>Nr. articol: 216-206</b><br>Ferrule; Sleeve for 2.5 mm <sup>2</sup> / AWG 14; insulated; electro-tin plated; blue         | <a href="http://www.wago.com/216-206">www.wago.com/216-206</a> |
| <b>Coding</b>  |  |  |
|    | <b>Nr. articol: 769-435</b><br>Coding pin; for coding of female plugs; for carrier terminal blocks / male connectors; orange | <a href="http://www.wago.com/769-435">www.wago.com/769-435</a> |
| <b>assembling</b>  |  |  |
|    | <b>Nr. articol: 769-499</b><br>Fixing screw M2.5 x 16; and hexagon nut M2.5  | <a href="http://www.wago.com/769-499">www.wago.com/769-499</a> |
| <b>tools</b>   |  |  |
|   | <b>Nr. articol: 210-490</b><br>Operating tool  | <a href="http://www.wago.com/210-490">www.wago.com/210-490</a> |
|  | <b>Nr. articol: 769-434</b><br>Push-button; loose  | <a href="http://www.wago.com/769-434">www.wago.com/769-434</a> |

## Descărcări

### Documentation

#### Additional Information

|                        |             |               |            |
|------------------------|-------------|---------------|------------|
| Technical explanations | Apr 3, 2019 | pdf<br>2,1 MB | Descărcare |
|------------------------|-------------|---------------|------------|

### CAD/CAE-Data

#### CAD data

|                              |     |            |
|------------------------------|-----|------------|
| 2D/3D Models 769-602/002-000 | URL | Descărcare |
|------------------------------|-----|------------|

#### CAE data

|                                   |     |            |
|-----------------------------------|-----|------------|
| EPLAN Data Portal 769-602/002-000 | URL | Descărcare |
|-----------------------------------|-----|------------|

|                                |     |            |
|--------------------------------|-----|------------|
| WSCAD Universe 769-602/002-000 | URL | Descărcare |
|--------------------------------|-----|------------|

Supus modificărilor.

WAGO Kontakttechnik GmbH & Co. KG  
/Representative Office Romania  
Sos. Pipera-Tunari nr. 1/1  
building 1, 2nd floor | 077190 Voluntari, Ilfov  
Tel.: +40-(0)31 421 85 68 | Email: info-RO@wago.com

Aveți întrebări despre produsele noastre?  
Vă stăm la dispoziție pentru preluarea apelului la +40 (0) 31 421 85 68.

## Installation Notes

### Assembly

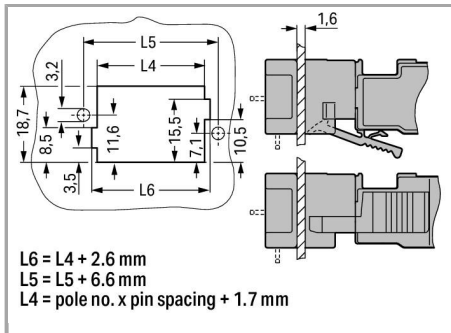

### Cutout

Male headers with solder pins and fixing flanges

### Inserting a conductor

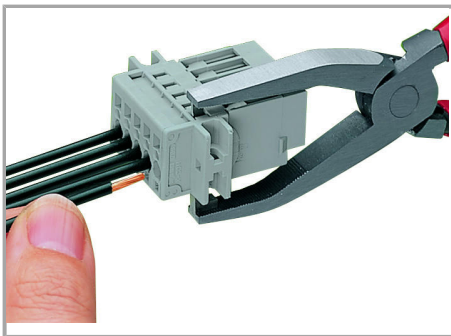

### Operating tool

Inserting a conductor via operating tool  
(example shows a male connector).

### Application

Supus modificărilor.



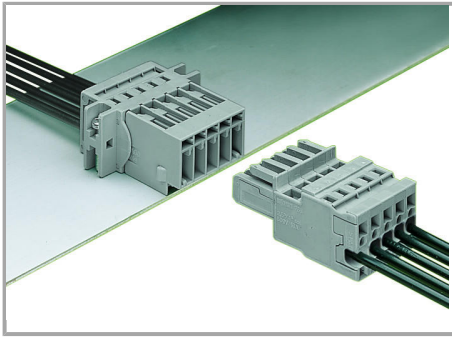

Male connector with CAGE CLAMP® and mounting flanges

1-connector female plug, straight

#### Marking

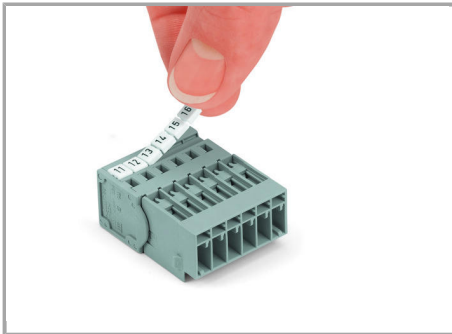

Labeling a male connector with CAGE CLAMP® connection via Mini-WSB quick markers.

#### Familie de produse

##### X-COM

Afișare globală produse din familie.

Supus modificărilor.