

RoHS Compliant

Culoare:

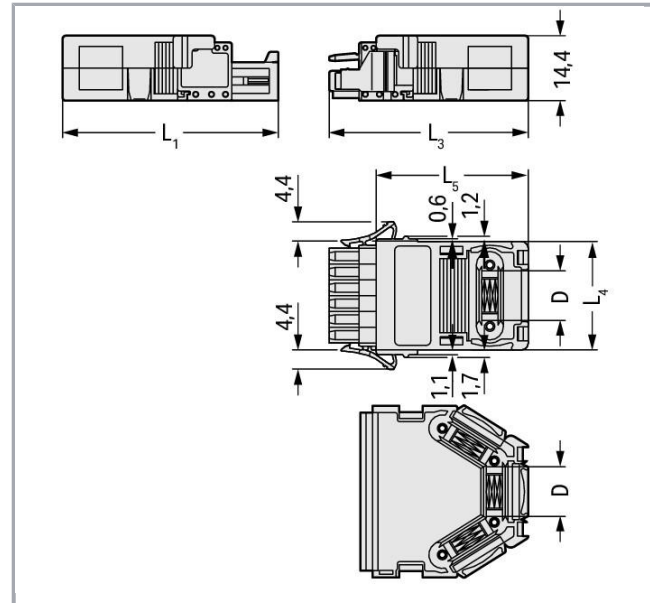

## Descriere articol

- Only for use with cable binders
- Cable binder width: max. 3.6 mm
- 1 x cable outlet, rear

## Date

### Electrical data

### Ratings per IEC/EN 60664-1

Legend (ratings)

(III / 2) ≙ Overvoltage category III / Pollution degree 2

### Approvals per UL 1059

Approvals per

UL 1059

Supus modificărilor.

WAGO Kontakttechnik GmbH & Co. KG  
/Representative Office Romania  
Sos. Pipera-Tunari nr. 1/1  
building 1, 2nd floor | 077190 Voluntari, Ilfov  
Tel.: +40-(0)31 421 85 68 | Email: info-RO@wago.com

Aveți întrebări despre produsele noastre?  
Vă stăm la dispoziție pentru preluarea apelului la +40 (0) 31 421 85 68.

### Connection data

Pole No.	2
Number of connection types	1

### Geometrical Data

Pin spacing	3,5 mm / 0.138 inch
Width	10 mm / 0.394 inch
Height	14,4 mm / 0.567 inch
Depth	32,7 mm / 1.287 inch

### Mechanical data

Suitable	for standard male and female connectors
----------	---

### Material Data

Color	light gray
Fire load	0,056 MJ
Weight	1,8 g

### Commercial data

Product Group	3 (Multi Conn. System)
Packaging type	BOX
Country of origin	DE
GTIN	4017332590754
Customs tariff number	39269097900

### Aprobări / certificate



#### Country specific Approvals

Emblemă	Aprobare	Text de aprobare suplimentar	Nume certificat
	CCA DEKRA Certification B.V.	EN 61984	2169534.02

#### Ship Approvals

Emblemă	Aprobare	Text de aprobare suplimentar	Nume certificat

Supus modificărilor.

	<b>ABS</b> American Bureau of Shipping	-	19- HG1869876- PDA
	<b>DNV GL</b> Det Norske Veritas, Germanischer Lloyd	-	TAE000016Z
	<b>LR</b> Lloyds Register	IEC 61984	96/20035 (E5)

## Counterpart

## Descărcări Documentation

### Additional Information

Technical explanations	Apr 3, 2019	pdf 3,6 MB	Descărcare
------------------------	-------------	---------------	------------

## CAD/CAE-Data

### CAD data

2D/3D Models 734-602	URL	Descărcare
----------------------	-----	------------

### CAE data

EPLAN Data Portal 734-602	URL	Descărcare
---------------------------	-----	------------

## Installation Notes

### Application

Supus modificărilor.

WAGO Kontakttechnik GmbH & Co. KG  
/Representative Office Romania  
Sos. Pipera-Tunari nr. 1/1  
building 1, 2nd floor | 077190 Voluntari, Ilfov  
Tel.: +40-(0)31 421 85 68 | Email: info-RO@wago.com

Aveți întrebări despre produsele noastre?  
Vă stăm la dispoziție pentru preluarea apelului la +40 (0) 31 421 85 68.

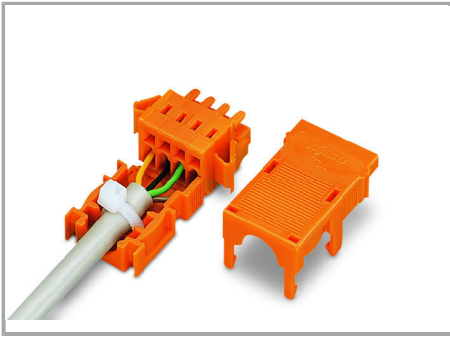

4-pole, 1-conductor female connector, with locking levers and strain relief housing (2- to 5-pole strain relief housing suitable only for cable ties)

#### Application

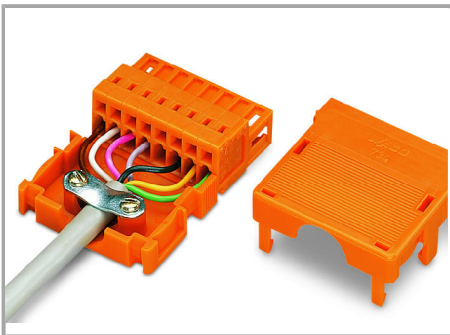

Strain relief housing for 734 Series Male and Female Connectors with CAGE CLAMP® connection.

Supus modificărilor.