

Fișă tehnică | Număr articol: 231-126

Testing plug module with contact stud; for 280, 736, 737, 738, 780 Series;

Pin spacing 5 mm / 0.197 in; 2,50 mm²; gray

www.wago.com/231-126

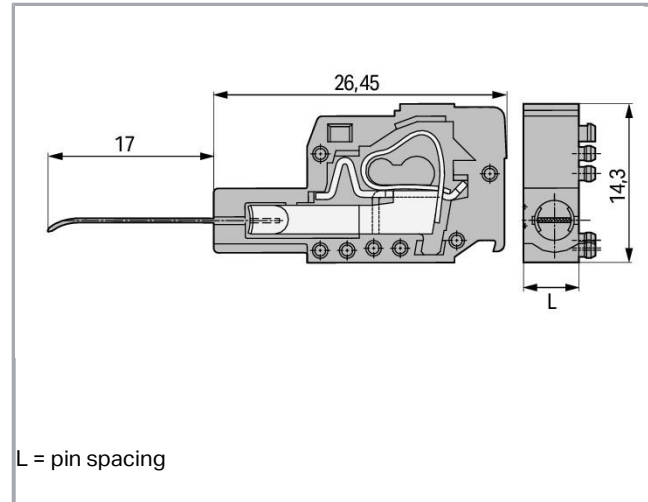
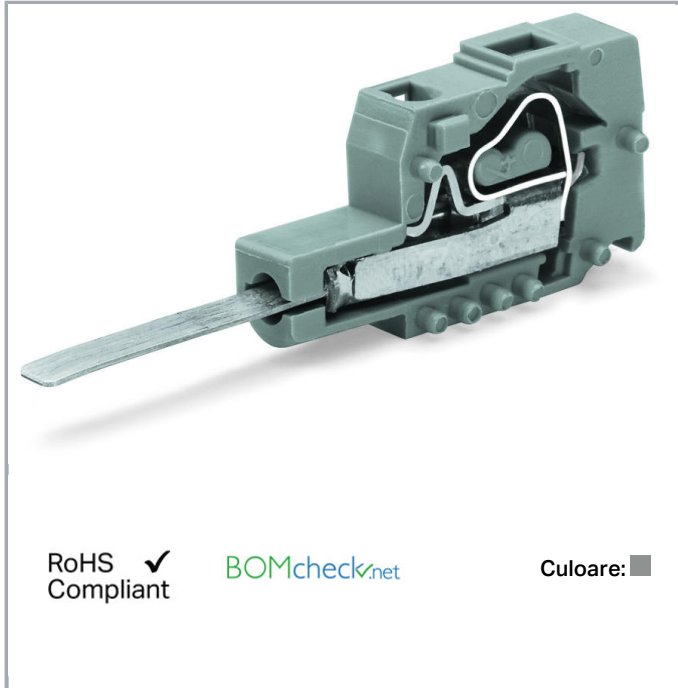

Date

Electrical data

Ratings per IEC/EN 60664-1

Ratings per	IEC/EN 60664-1
Rated voltage (III/2)	250 V
Rated surge voltage (III/2)	2,5 kV
Rated current	0,5 A
Legend (ratings)	(III / 2) ≙ Overvoltage category III / Pollution degree 2

Approvals per UL 1059

Approvals per	UL 1059
---------------	---------

Connection data

Connection technology	CAGE CLAMP®
-----------------------	-------------

Supus modificărilor.

WAGO Kontakttechnik GmbH & Co. KG
/Representative Office Romania
Sos. Pipera-Tunari nr. 1/1
building 1, 2nd floor | 077190 Voluntari, Ilfov
Tel.: +40-(0)31 421 85 68 | Email: info-RO@wago.com

Aveți întrebări despre produsele noastre?
Vă stăm la dispoziție pentru preluarea apelului la +40 (0) 31 421 85 68.



Solid conductor	0,08 ... 2,5 mm ² / 28 ... 12 AWG
Fine-stranded conductor	0,08 ... 2,5 mm ² / 28 ... 12 AWG
Strip length	12 ... 13 mm / 0.47 ... 0.51 inch
Total number of connection points	1
Total number of potentials	1
Number of connection types	1

Geometrical Data

Pin spacing	5 mm / 0.197 inch
Width	5 mm / 0.197 inch
Height	14,3 mm / 0.563 inch
Depth	43,45 mm / 1.711 inch

Mechanical data

Test contact length	17 mm
Application	Testing without connected conductor
Suitable	for 280, 736, 737, 738, 780 Series

Material Data

Color	gray
Material group	I
Insulation material	Polyamide 66 (PA 66)
Flammability class per UL94	V0
Clamping spring material	Chrome nickel spring steel (CrNi)
Contact material	Electrolytic copper (E _{Cu})
Contact plating	tin-plated
Fire load	0,024 MJ
Weight	2,1 g

Environmental Requirements

Limit temperature range	-60 ... +105 °C
-------------------------	-----------------

Commercial data

Product Group	3 (Multi Conn. System)
Packaging type	BOX
Country of origin	DE

Supus modificărilor.

WAGO Kontakttechnik GmbH & Co. KG
 /Representative Office Romania
 Sos. Pipera-Tunari nr. 1/1
 building 1, 2nd floor | 077190 Voluntari, Ilfov
 Tel.: +40-(0)31 421 85 68 | Email: info-RO@wago.com

Aveți întrebări despre produsele noastre?
 Vă stăm la dispoziție pentru preluarea apelului la +40 (0) 31 421 85 68.

GTIN	4045454193584
Customs tariff number	85366990990

Aprobări / certificate

Country specific Approvals

Emblemă	Aprobare	Text de aprobare suplimentar	Nume certificat
	CSA DEKRA Certification B.V.	C22.2	1466354



Ship Approvals

Emblemă	Aprobare	Text de aprobare suplimentar	Nume certificat
	LR Lloyds Register	IEC 61984	96 /20035 (E5)

Counterpart

Produse compatibile

tools

	Nr. articol: 210-657 Operating tool; Blade: 3.5 x 0.5 mm; with a partially insulated shaft; short	www.wago.com/210-657
	Nr. articol: 210-720 Operating tool; Blade: 3.5 x 0.5 mm; with a partially insulated shaft	www.wago.com/210-720

Descărcări

Documentation

Additional Information

Technical explanations	Apr 3, 2019	pdf 3,6 MB	Descărcare
------------------------	-------------	---------------	------------

Installation Notes

Supus modificărilor.

WAGO Kontakttechnik GmbH & Co. KG
/Representative Office Romania
Sos. Pipera-Tunari nr. 1/1
building 1, 2nd floor | 077190 Voluntari, Ilfov
Tel.: +40-(0)31 421 85 68 | Email: info-RO@wago.com

Aveți întrebări despre produsele noastre?
Vă stăm la dispoziție pentru preluarea apelului la +40 (0) 31 421 85 68.

Assembly

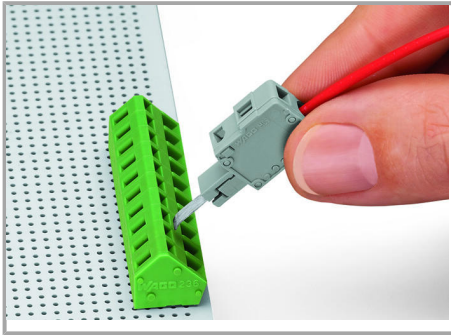

Inserting a test plug module into the operating slot.

Testing

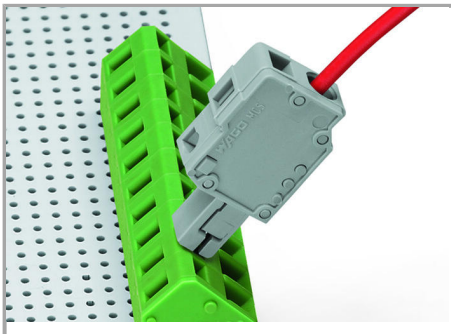

Unwired terminal strip with inserted test plug module

Application

Supus modificărilor.

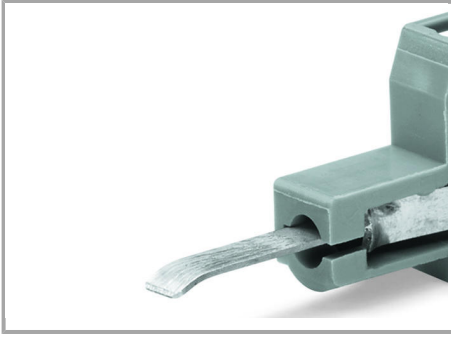

Contact type A:

Testing only when unwired.

Supus modificărilor.