

Fișă tehnică | Număr articol: 2001-511

Modular TOPJOB®S connector; modular; for jumper contact slot; 1-pole;  
1,50 mm<sup>2</sup>; gray

[www.wago.com/2001-511](http://www.wago.com/2001-511)



Supus modificărilor.

WAGO Kontakttechnik GmbH & Co. KG  
/Representative Office Romania  
Sos. Pipera-Tunari nr. 1/1  
building 1, 2nd floor | 077190 Voluntari, Ilfov  
Tel.: +40-(0)31 421 85 68 | Email: info-RO@wago.com

Aveți întrebări despre produsele noastre?  
Vă stăm la dispoziție pentru preluarea apelului la +40 (0) 31 421 85 68.



Supus modificărilor.

RoHS   
Compliant

BOMcheck.net

Culoare: 

## Descriere articol

### Safety information 1:

According to EN 61984, pluggable connectors without current interrupting capacity shall not be mated and unmated when live or under load.

## Date

### Electrical data

#### Ratings per IEC/EN 60664-1

Nominal voltage (III/3)	500 V
Rated surge voltage (III/3)	6 kV
Rated current	18 A
Legend (ratings)	(III / 3) ≙ Overvoltage category III / Pollution degree 3

#### Approvals per UL 1059

Rated voltage UL (Use Group B)	300 V
Rated current UL (Use Group B)	15 A
Rated voltage UL (Use Group C)	300 V
Rated current UL (Use Group C)	15 A
Approvals per	UL 1059

### Connection data

Connection technology	Push-in CAGE CLAMP®
Actuation type	Open Tool Slot
Connectable conductor materials	Copper
Nominal cross-section	1.5 mm <sup>2</sup>
Solid conductor	0.25 ... 2.5 mm <sup>2</sup> / 22 ... 14 AWG
Solid conductor; push-in termination	0.75 ... 2.5 mm <sup>2</sup> / 18 ... 14 AWG
Fine-stranded conductor	0.25 ... 2.5 mm <sup>2</sup> / 22 ... 14 AWG
Fine-stranded conductor; with insulated ferrule	0.75 ... 1.5 mm <sup>2</sup> / 18 ... 16 AWG
Fine-stranded conductor; with ferrule; push-in termination	0.75 ... 1.5 mm <sup>2</sup> / 18 ... 16 AWG

Supus modificărilor.

WAGO Kontakttechnik GmbH & Co. KG  
/Representative Office Romania  
Sos. Pipera-Tunari nr. 1/1  
building 1, 2nd floor | 077190 Voluntari, Ilfov  
Tel.: +40-(0)31 421 85 68 | Email: info-RO@wago.com

Aveți întrebări despre produsele noastre?  
Vă stăm la dispoziție pentru preluarea apelului la +40 (0) 31 421 85 68.



Strip length	9 ... 11 mm / 0.35 ... 0.43 inch
Pole No.	1
Total number of connection points	1
Total number of potentials	1
Wiring type	Side-entry wiring
Note (conductor cross-section)	Depending on the conductor characteristic, a conductor with a smaller cross section can also be inserted via push-in termination.

### Geometrical Data

Width	4.2 mm / 0.165 inch
Module width	4.2 mm / 0.165 inch

### Mechanical data

Marking level	Center/side marking
---------------	---------------------

### Material Data

Color	gray
Insulation material	Polyamide 66 (PA 66)
Fire load	0,07 MJ
Weight	2,2 g

### Commercial data

Product Group	22 (TOPJOB S)
Packaging type	BOX
Country of origin	DE
GTIN	4044918975148
Customs tariff number	85366990990

### Aprobări / certificate

#### UL-Approvals

Emblemă	Aprobare	Text de aprobare suplimentar	Nume certificat
	UL UL International Germany GmbH	UL 1059	20190731- E45172

Supus modificărilor.





WAGO Kontakttechnik GmbH & Co. KG  
 /Representative Office Romania  
 Sos. Pipera-Tunari nr. 1/1  
 building 1, 2nd floor | 077190 Voluntari, Ilfov  
 Tel.: +40-(0)31 421 85 68 | Email: info-RO@wago.com

Aveți întrebări despre produsele noastre?  
 Vă stăm la dispoziție pentru preluarea apelului la +40 (0) 31 421 85 68.

## Counterpart

## Produse compatibile







## ferrule

	<b>Nr. articol: 216-241</b> Ferrule; Sleeve for 0.5 mm <sup>2</sup> / 20 AWG; insulated; electro-tin plated; electrolytic copper; gastight crimped; acc. to DIN 46228, Part 4/09.90; white	<a href="http://www.wago.com/216-241">www.wago.com/216-241</a>
	<b>Nr. articol: 216-242</b> Ferrule; Sleeve for 0.75 mm <sup>2</sup> / 18 AWG; insulated; electro-tin plated; electrolytic copper; gastight crimped; acc. to DIN 46228, Part 4/09.90; gray	<a href="http://www.wago.com/216-242">www.wago.com/216-242</a>
	<b>Nr. articol: 216-243</b> Ferrule; Sleeve for 1 mm <sup>2</sup> / AWG 18; insulated; electro-tin plated; electrolytic copper; gastight crimped; acc. to DIN 46228, Part 4/09.90; red	<a href="http://www.wago.com/216-243">www.wago.com/216-243</a>
	<b>Nr. articol: 216-244</b> Ferrule; Sleeve for 1.5 mm <sup>2</sup> / AWG 16; insulated; electro-tin plated; electrolytic copper; gastight crimped; acc. to DIN 46228, Part 4/09.90; black	<a href="http://www.wago.com/216-244">www.wago.com/216-244</a>

## Insulation stop

	<b>Nr. articol: 2001-171</b> Insulation stop; 0.25 - 0.5 mm <sup>2</sup> ; 5 pieces/strip; light gray	<a href="http://www.wago.com/2001-171">www.wago.com/2001-171</a>
--	--	--

## Marking accessories

	<b>Nr. articol: 2009-110</b> Marking strips; on reel; not stretchable; plain; snap-on type; white	<a href="http://www.wago.com/2009-110">www.wago.com/2009-110</a>
	<b>Nr. articol: 793-4501</b> WMB marking card; as card; stretchable 4 - 4.2 mm; plain; snap-on type; white	<a href="http://www.wago.com/793-4501">www.wago.com/793-4501</a>
	<b>Nr. articol: 793-4501/000-002</b> WMB marking card; as card; stretchable 4 - 4.2 mm; plain; snap-on type; yellow	<a href="http://www.wago.com/793-4501/000-002">www.wago.com/793-4501/000-002</a>
	<b>Nr. articol: 793-4501/000-005</b> WMB marking card; as card; stretchable 4 - 4.2 mm; plain; snap-on type; red	<a href="http://www.wago.com/793-4501/000-005">www.wago.com/793-4501/000-005</a>
	<b>Nr. articol: 793-4501/000-006</b> WMB marking card; as card; stretchable 4 - 4.2 mm; plain; snap-on type; blue	<a href="http://www.wago.com/793-4501/000-006">www.wago.com/793-4501/000-006</a>
	<b>Nr. articol: 793-4501/000-007</b> WMB marking card; as card; stretchable 4 - 4.2 mm; plain; snap-on type; gray	<a href="http://www.wago.com/793-4501/000-007">www.wago.com/793-4501/000-007</a>

## Supus modificărilor.

WAGO Kontakttechnik GmbH & Co. KG  
/Representative Office Romania  
Sos. Pipera-Tunari nr. 1/1  
building 1, 2nd floor | 077190 Voluntari, Ilfov  
Tel.: +40-(0)31 421 85 68 | Email: info-RO@wago.com

Aveți întrebări despre produsele noastre?  
Vă stăm la dispoziție pentru preluarea apelului la +40 (0) 31 421 85 68.



**Nr. articol: 793-4501/000-012**  
WMB marking card; as card; stretchable 4 - 4.2 mm; plain; snap-on type; orange

[www.wago.com/793-4501/000-012](http://www.wago.com/793-4501/000-012)



**Nr. articol: 793-4501/000-017**  
WMB marking card; as card; stretchable 4 - 4.2 mm; plain; snap-on type; green

[www.wago.com/793-4501/000-017](http://www.wago.com/793-4501/000-017)



**Nr. articol: 793-4501/000-023**  
WMB marking card; as card; stretchable 4 - 4.2 mm; plain; snap-on type; light green

[www.wago.com/793-4501/000-023](http://www.wago.com/793-4501/000-023)



**Nr. articol: 793-4501/000-024**  
WMB marking card; as card; stretchable 4 - 4.2 mm; plain; snap-on type; violet

[www.wago.com/793-4501/000-024](http://www.wago.com/793-4501/000-024)

#### check



**Nr. articol: 2001-549**  
Spacer module; modular; e.g., for bridging commoned terminal blocks; gray

[www.wago.com/2001-549](http://www.wago.com/2001-549)



**Nr. articol: 210-136**  
Test plug; 2 mm Ø; with 500 mm cable; red

[www.wago.com/210-136](http://www.wago.com/210-136)



**Nr. articol: 210-137**  
Test plug; 2.3 mm Ø; with 500 mm cable; yellow

[www.wago.com/210-137](http://www.wago.com/210-137)

#### End plate



**Nr. articol: 2002-541**  
End plate; for modular TOPJOB®S connector; 1.5 mm thick; gray

[www.wago.com/2002-541](http://www.wago.com/2002-541)

#### tools



**Nr. articol: 210-647**  
Operating tool; Blade: 2.5 x 0.4 mm; with a partially insulated shaft

[www.wago.com/210-647](http://www.wago.com/210-647)



**Nr. articol: 210-648**  
Operating tool; Blade: 2.5 x 0.4 mm; with a partially insulated shaft; angled; short

[www.wago.com/210-648](http://www.wago.com/210-648)



**Nr. articol: 210-719**  
Operating tool; Blade: 2.5 x 0.4 mm; with a partially insulated shaft

[www.wago.com/210-719](http://www.wago.com/210-719)

## Descărcări

### Documentation

#### Additional Information

Technical explanations

Apr 3, 2019

pdf  
2,1 MB

Descărcare

Supus modificărilor.

## CAD/CAE-Data

### CAD data

2D/3D Models 2001-511	<a href="#">URL</a>	<a href="#">Descărcare</a>
-----------------------	---------------------	----------------------------

### CAE data

WSCAD Universe 2001-511	<a href="#">URL</a>	<a href="#">Descărcare</a>
-------------------------	---------------------	----------------------------

## Installation Notes

### Installation

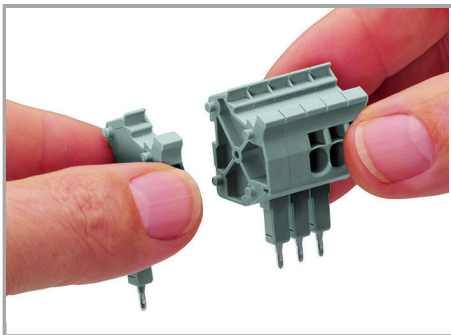

Snapping connectors and spacers together to assemble a multipole connector.

### Conductor termination

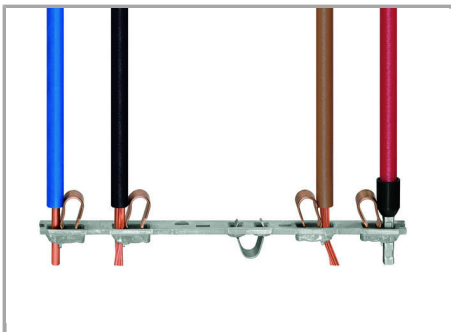

All conductor types at a glance

Supus modificărilor.

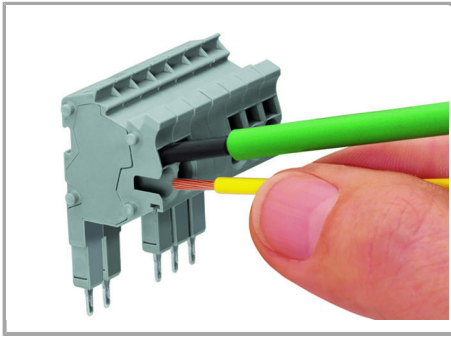

#### Conductor termination via:

- Operating tool for fine-stranded conductors without ferrules
- 
- Push-in connection of solid conductors
- 

#### Strain Relief

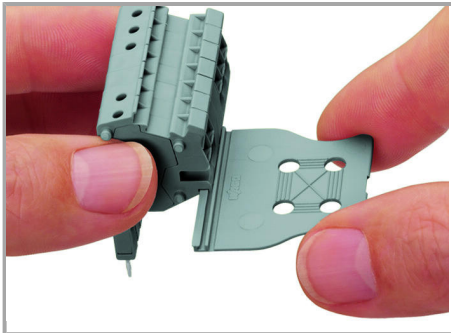

Snapping on a strain relief plate.

#### Testing

Supus modificărilor.



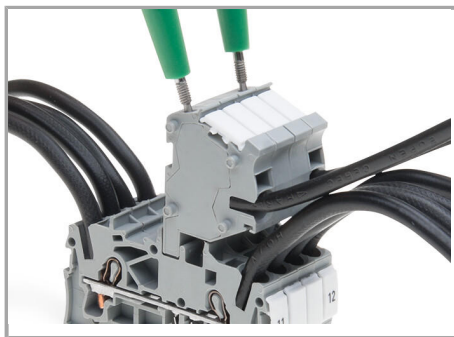

TOPJOB® S Connectors with a 2 mm Ø test socket for testing voltage via 2-pole voltage tester

#### Application

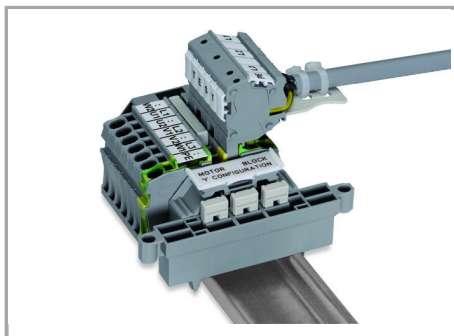

Rail-mount terminal block assembly for electric motor wiring

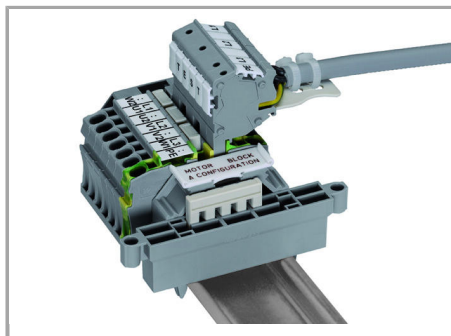

Rail-mount terminal block assembly for electric motor wiring

#### Familie de produse

##### TOPJOB® S

TOPJOB® S: In various industrial applications and modern building installations, WAGO's wide and versatile range of rail-mount terminal blocks provides more than just reliable electrical connections.

[Afișare globală produse din familie.](#)

Supus modificărilor.