

Fișă tehnică | Număr articol: 769-602/006-000

1-conductor male connector; Snap-in flange; 4 mm²; Pin spacing 5 mm; 2-pole; 4,00 mm²; gray

www.wago.com/769-602/006-000

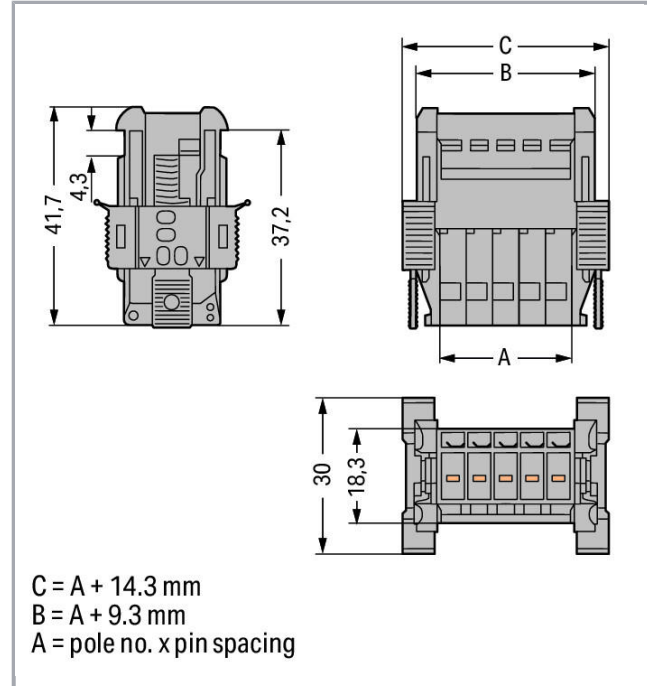
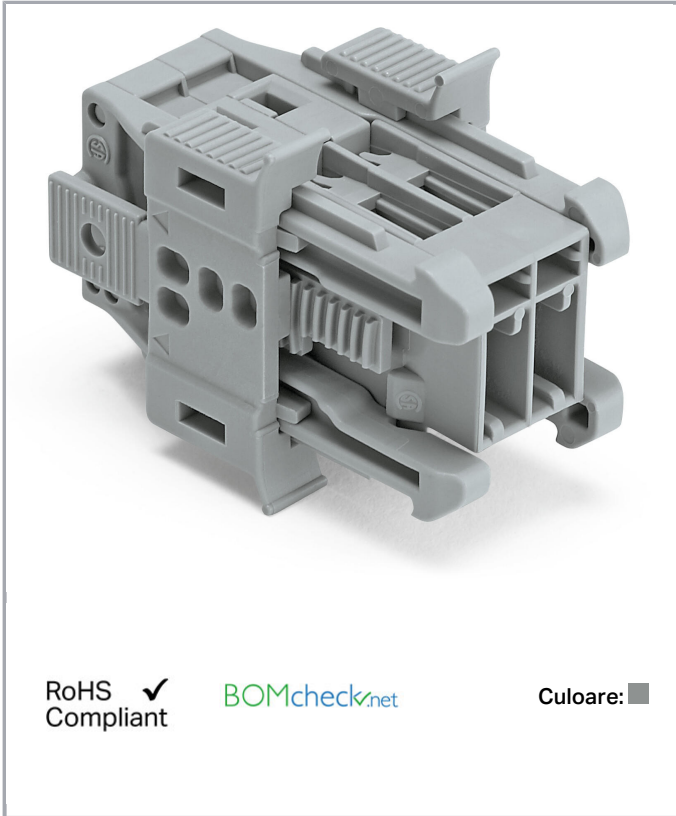

Supus modificărilor.

WAGO Kontakttechnik GmbH & Co. KG
/Representative Office Romania
Sos. Pipera-Tunari nr. 1/1
building 1, 2nd floor | 077190 Voluntari, Ilfov
Tel.: +40-(0)31 421 85 68 | Email: info-RO@wago.com

Aveți întrebări despre produsele noastre?
Vă stăm la dispoziție pentru preluarea apelului la +40 (0) 31 421 85 68.

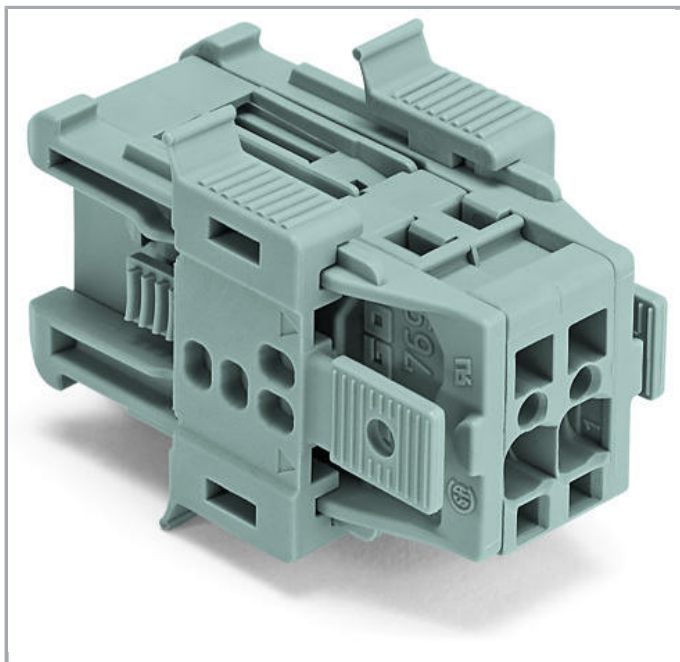
**Date****Electrical data****Ratings per IEC/EN 60664-1**

Nominal voltage (III/3)	500 V
Rated surge voltage (III/3)	6 kV
Rated current	32 A
Legend (ratings)	(III / 3) ≙ Overvoltage category III / Pollution degree 3

Connection data

Connection technology	CAGE CLAMP®
Actuation type	Operating tool
Connectable conductor materials	Copper
Nominal cross-section	4 mm ²
Solid conductor	0,08 ... 4 mm ² / 28 ... 12 AWG
Fine-stranded conductor	0,08 ... 4 mm ² / 28 ... 12 AWG
Strip length	8 ... 9 mm / 0.31 ... 0.35 inch
Pole No.	2
Total number of connection points	2
Total number of potentials	2

Supus modificărilor.

WAGO Kontakttechnik GmbH & Co. KG
 /Representative Office Romania
 Sos. Pipera-Tunari nr. 1/1
 building 1, 2nd floor | 077190 Voluntari, Ilfov
 Tel.: +40-(0)31 421 85 68 | Email: info-RO@wago.com

Aveți întrebări despre produsele noastre?
 Vă stăm la dispoziție pentru preluarea apelului la +40 (0) 31 421 85 68.



Wiring type	Side-entry wiring
-------------	-------------------

Geometrical Data

Pin spacing	5 mm / 0.197 inch
Width	24,3 mm / 0.957 inch
Height	30 mm / 1.181 inch
Depth	41,7 mm / 1.642 inch

Mechanical data

Mounting type	Snap-in
---------------	---------

Plug connection

Contact type (pluggable connector)	Male connector/plug
Connector (connection type)	for conductor

Material Data

Color	gray
Insulation material	Polyamide 66 (PA 66)
Fire load	0,282 MJ
Weight	11,3 g

Commercial data

Product Group	18 (X-COM-System)
Packaging type	BOX
Country of origin	PL
GTIN	4045454916985
Customs tariff number	85366990990

Aprobări / certificate**Country specific Approvals**

Emblemă	Aprobare	Text de aprobare suplimentar	Nume certificat
	CCA DEKRA Certification B.V.	EN 61984	2190419.02
	CSA	C22.2 No. 158	1101144

Supus modificărilor.



WAGO Kontakttechnik GmbH & Co. KG
/Representative Office Romania
Sos. Pipera-Tunari nr. 1/1
building 1, 2nd floor | 077190 Voluntari, Ilfov
Tel.: +40-(0)31 421 85 68 | Email: info-RO@wago.com

Aveți întrebări despre produsele noastre?
Vă stăm la dispoziție pentru preluarea apelului la +40 (0) 31 421 85 68.



DEKRA Certification B.V.





UL-Approvals

Emblemă	Aprobare	Text de aprobare suplimentar	Nume certificat
	UR Underwriters Laboratories Inc.	UL 1977	20151210- E45171
	UR Underwriters Laboratories Inc.	UL 1059	20190731- E45172

Counterpart

Produse compatibile















Marking accessories

	Nr. articol: 2009-145 Mini-WSB Inline; for Smart Printer; 1700 pieces on roll; stretchable 5 - 5.2 mm; plain; snap-on type; white	www.wago.com/2009-145
	Nr. articol: 2009-145/000-002 Mini-WSB Inline; for Smart Printer; 1700 pieces on roll; stretchable 5 - 5.2 mm; plain; snap-on type; yellow	www.wago.com/2009-145/000-002
	Nr. articol: 2009-145/000-005 Mini-WSB Inline; for Smart Printer; 1700 pieces on roll; stretchable 5 - 5.2 mm; plain; snap-on type; red	www.wago.com/2009-145/000-005
	Nr. articol: 2009-145/000-006 Mini-WSB Inline; for Smart Printer; 1700 pieces on roll; stretchable 5 - 5.2 mm; plain; snap-on type; blue	www.wago.com/2009-145/000-006

Supus modificărilor.

WAGO Kontakttechnik GmbH & Co. KG
/Representative Office Romania
Sos. Pipera-Tunari nr. 1/1
building 1, 2nd floor | 077190 Voluntari, Ilfov
Tel.: +40-(0)31 421 85 68 | Email: info-RO@wago.com

Aveți întrebări despre produsele noastre?
Vă stăm la dispoziție pentru preluarea apelului la +40 (0) 31 421 85 68.

	Nr. articol: 2009-145/000-007 Mini-WSB Inline; for Smart Printer; 1700 pieces on roll; stretchable 5 - 5.2 mm; plain; snap-on type; gray	www.wago.com/2009-145/000-007
	Nr. articol: 2009-145/000-012 Mini-WSB Inline; for Smart Printer; 1700 pieces on roll; stretchable 5 - 5.2 mm; plain; snap-on type; orange	www.wago.com/2009-145/000-012
	Nr. articol: 2009-145/000-023 Mini-WSB Inline; for Smart Printer; 1700 pieces on roll; stretchable 5 - 5.2 mm; plain; snap-on type; green	www.wago.com/2009-145/000-023
	Nr. articol: 2009-145/000-024 Mini-WSB Inline; for Smart Printer; 1700 pieces on roll; stretchable 5 - 5.2 mm; plain; snap-on type; violet	www.wago.com/2009-145/000-024
	Nr. articol: 210-831 Marking strips; on reel; 2.3 mm wide; plain; Self-adhesive; white	www.wago.com/210-831
	Nr. articol: 210-832 Marking strips; on reel; 3 mm wide; plain; Self-adhesive; white	www.wago.com/210-832
	Nr. articol: 210-833 Marking strips; on reel; 6 mm wide; plain; Self-adhesive; white	www.wago.com/210-833
	Nr. articol: 210-834 Marking strips; on reel; 5 mm wide; plain; Self-adhesive; white	www.wago.com/210-834
	Nr. articol: 248-501 Miniature WSB Quick marking system; plain; Marker width 5 mm; 10 strips with 10 markers per card	www.wago.com/248-501
	Nr. articol: 248-501/000-002 Mini-WSB marking card; as card; not stretchable; plain; snap-on type; yellow	www.wago.com/248-501/000-002
	Nr. articol: 248-501/000-005 Mini-WSB marking card; as card; not stretchable; plain; snap-on type; red	www.wago.com/248-501/000-005
	Nr. articol: 248-501/000-006 Mini-WSB marking card; as card; not stretchable; plain; snap-on type; blue	www.wago.com/248-501/000-006
	Nr. articol: 248-501/000-007 Mini-WSB marking card; as card; not stretchable; plain; snap-on type; gray	www.wago.com/248-501/000-007
	Nr. articol: 248-501/000-012 Mini-WSB marking card; as card; not stretchable; plain; snap-on type; orange	www.wago.com/248-501/000-012
	Nr. articol: 248-501/000-017 Mini-WSB marking card; as card; not stretchable; plain; snap-on type; light green	www.wago.com/248-501/000-017

Supus modificărilor.



Nr. articol: 248-501/000-023

Mini-WSB marking card; as card; not stretchable; plain; snap-on type; green

www.wago.com/248-501/000-023

Nr. articol: 248-501/000-024

Mini-WSB marking card; as card; not stretchable; plain; snap-on type; violet

www.wago.com/248-501/000-024

Female plug



Nr. articol: 769-101

1-conductor female plug; 4 mm²; 1-pole; 4,00 mm²; graywww.wago.com/769-101

Nr. articol: 769-101/000-016

1-conductor female plug; 4 mm²; 1-pole; 4,00 mm²; green-yellowwww.wago.com/769-101/000-016

Nr. articol: 769-102

1-conductor female plug; 4 mm²; 2-pole; 4,00 mm²; graywww.wago.com/769-102

Nr. articol: 769-102/000-036

1-conductor female plug; 4 mm²; 2-pole; 4,00 mm²; gray, green-yellowwww.wago.com/769-102/000-036

Nr. articol: 769-102/000-037

1-conductor female plug; 4 mm²; 2-pole; 4,00 mm²; green-yellow, graywww.wago.com/769-102/000-037

Nr. articol: 769-102/021-000

1-conductor female plug; Locking lever; 4 mm²; 2-pole; 4,00 mm²; graywww.wago.com/769-102/021-000

Nr. articol: 769-121

2-conductor female connector; 4 mm²; 1-pole; 4,00 mm²; graywww.wago.com/769-121

Nr. articol: 769-121/000-016

2-conductor female connector; 4 mm²; 1-pole; 4,00 mm²; green-yellowwww.wago.com/769-121/000-016

Nr. articol: 769-122

2-conductor female connector; 4 mm²; 2-pole; 4,00 mm²; graywww.wago.com/769-122

Protective Warning Marker



Nr. articol: 280-415

Protective warning marker; with high-voltage symbol, black; for 5 terminal blocks; yellow

www.wago.com/280-415

Coding



Nr. articol: 769-435

Coding pin; for coding of female plugs; for carrier terminal blocks / male connectors; orange

www.wago.com/769-435

Insulation stop

Nr. articol: 769-470

Insulation stop; 0.08 - 0.2 mm² "s" (0.14 mm² "f-st"); 5 pieces/strip; whitewww.wago.com/769-470

Supus modificărilor.



Nr. articol: 769-471
Insulation stop; 0.25 - 0.5 mm²; 5 pieces/strip; light gray

www.wago.com/769-471



Nr. articol: 769-472
Insulation stop; 0.75 - 1 mm²; 5 pieces/strip; dark gray

www.wago.com/769-472

tools



Nr. articol: 210-490
Operating tool

www.wago.com/210-490



Nr. articol: 769-434
Push-button; loose

www.wago.com/769-434

Strain relief plate



Nr. articol: 769-410
Strain relief plate; gray

www.wago.com/769-410



Nr. articol: 769-411
Strain relief plate; gray

www.wago.com/769-411

ferrule



Nr. articol: 216-101
Ferrule; Sleeve for 0.5 mm² / AWG 22; uninsulated; electro-tin plated

www.wago.com/216-101



Nr. articol: 216-102
Ferrule; Sleeve for 0.75 mm² / AWG 20; uninsulated; electro-tin plated

www.wago.com/216-102



Nr. articol: 216-103
Ferrule; Sleeve for 1 mm² / AWG 18; uninsulated; electro-tin plated

www.wago.com/216-103



Nr. articol: 216-104
Ferrule; Sleeve for 1.5 mm² / AWG 16; uninsulated; electro-tin plated

www.wago.com/216-104



Nr. articol: 216-201
Ferrule; Sleeve for 0.5 mm² / 20 AWG; insulated; electro-tin plated; white

www.wago.com/216-201



Nr. articol: 216-202
Ferrule; Sleeve for 0.75 mm² / 18 AWG; insulated; electro-tin plated; gray

www.wago.com/216-202



Nr. articol: 216-203
Ferrule; Sleeve for 1 mm² / AWG 18; insulated; electro-tin plated; red

www.wago.com/216-203



Nr. articol: 216-204
Ferrule; Sleeve for 1.5 mm² / AWG 16; insulated; electro-tin plated; black

www.wago.com/216-204



Nr. articol: 216-206
Ferrule; Sleeve for 2.5 mm² / AWG 14; insulated; electro-tin plated; blue

www.wago.com/216-206

Supus modificărilor.

Descărcări Documentation

Additional Information

Technical explanations

Apr 3, 2019

pdf
2,1 MB

Descărcare

CAD/CAE-Data

CAD data

2D/3D Models 769-602/006-000

URL

Descărcare

CAE data

EPLAN Data Portal 769-602/006-000

URL

Descărcare

WSCAD Universe 769-602/006-000

URL

Descărcare

Installation Notes

Assembly

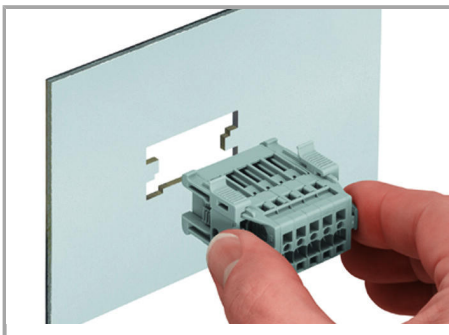

Insert male connector with snap-in flanges (769-605/006-000) into the cutout.

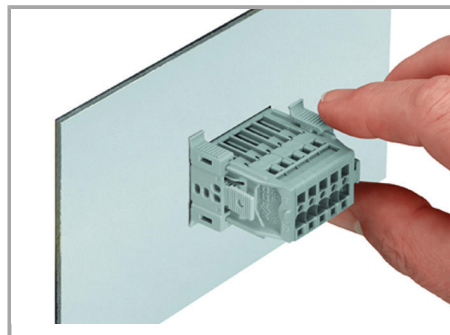

Secure the snap-in flange.

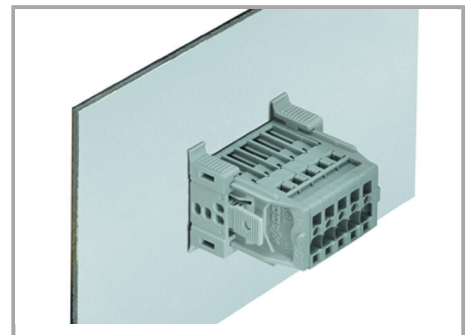

Male connector with snap-in flanges (769-605/006-000) into the cutout

Supus modificărilor.

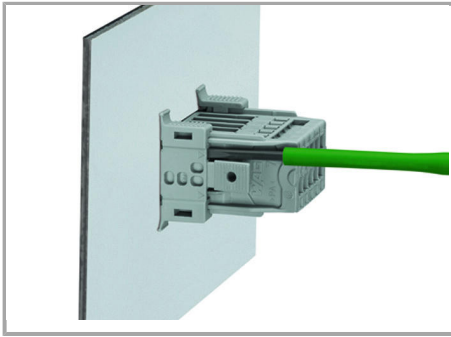

For removal, insert operating tool (2.5 mm blade) into release slot.

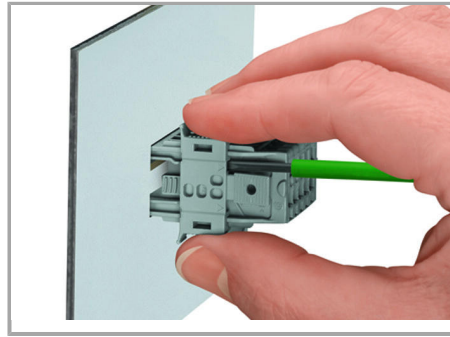

Press center part on both the top and bottom of the connector. Then remove snap-in flange.

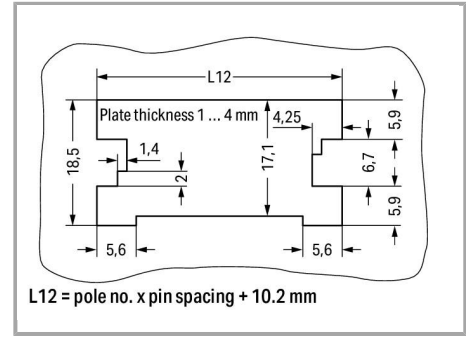

Sheet metal cutout (for female plugs without locking levers)

Male connectors with CAGE CLAMP® connection (769-6xx/006-000) and snap-in flanges

Inserting a conductor

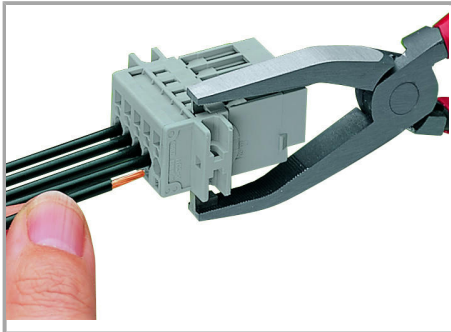

Operating tool

Inserting a conductor via operating tool (example shows a male connector).

Marking

Supus modificărilor.

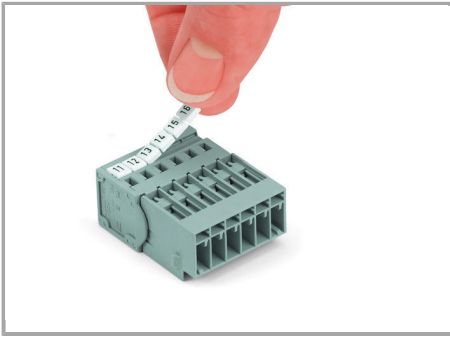

Labeling a male connector with
CAGE CLAMP® connection via Mini-WSB
quick markers.

Familie de produse

X-COM

Afișare globală produse din familie.

Supus modificărilor.