

## Fișă tehnică | Număr articol: 280-686

4-conductor carrier terminal block; for DIN-rail 35 x 15 and 35 x 7.5; 2.5 mm<sup>2</sup>; CAGE CLAMP®; 2,50 mm<sup>2</sup>; gray

[www.wago.com/280-686](http://www.wago.com/280-686)

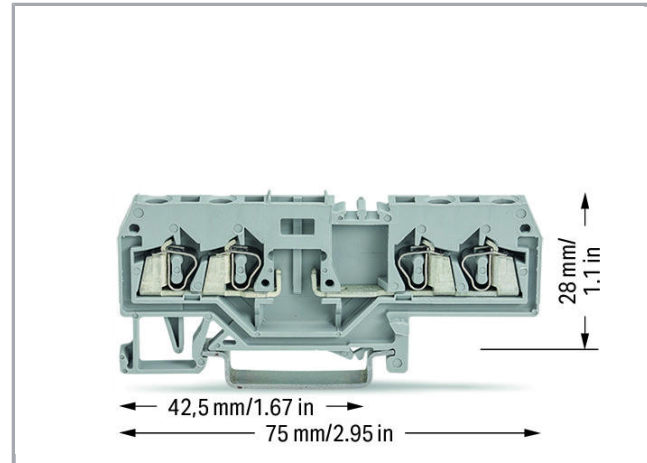
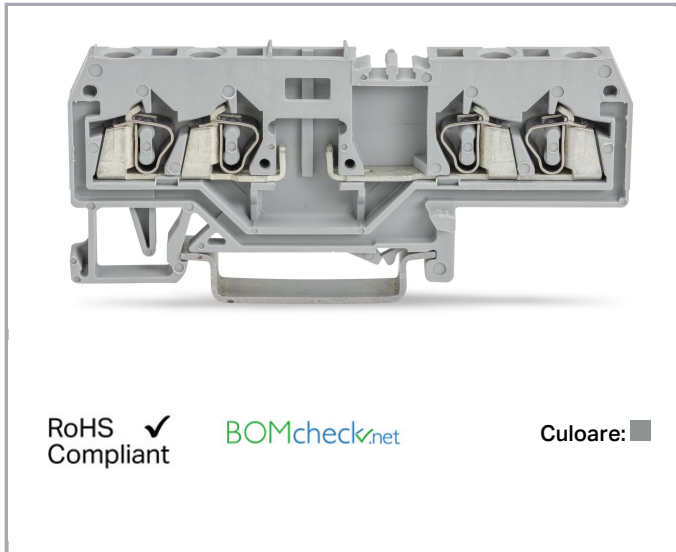

### Descriere articol

#### Note:

##### Terminating Aluminum Conductors

WAGO spring clamp terminal blocks are suitable for solid aluminum conductors up to 4 mm<sup>2</sup>/12 AWG if WAGO "Alu-Plus" Contact Paste is used for termination.

"Alu-Plus" Contact Paste Advantages:

- Automatically destroys the oxide film during clamping.
- Prevents fresh oxidation at the clamping point.
- Prevents electrolytic corrosion between aluminum and copper conductors (in the same terminal block).
- Provides long-term protection against corrosion.

Using terminal blocks with CAGE CLAMP® Spring Pressure Connection Technology, **aluminum conductors must first be cleaned with a blade and then immediately be inserted into the clamping units filled with "Alu-Plus" Contact Paste.**

It is also possible to apply WAGO "Alu-Plus" **additionally** on the whole surface of the aluminum conductor before termination.

Please note that the nominal currents must be adapted to the reduced conductivity of the aluminum conductors:

2.5 mm<sup>2</sup> (14 AWG) = 16 A

4 mm<sup>2</sup> (12 AWG) = 22 A

Supus modificărilor.

WAGO Kontakttechnik GmbH & Co. KG  
/Representative Office Romania  
Sos. Pipera-Tunari nr. 1/1  
building 1, 2nd floor | 077190 Voluntari, Ilfov  
Tel.: +40-(0)31 421 85 68 | Email: info-RO@wago.com

Aveți întrebări despre produsele noastre?  
Vă stăm la dispoziție pentru preluarea apelului la +40 (0) 31 421 85 68.

**Date****Electrical data****Ratings per IEC/EN 60664-1**

Ratings per	IEC/EN 60947-7-1
Nominal voltage (III/3)	400 V
Rated surge voltage (III/3)	6 kV
Rated current	10 A
Legend (ratings)	(III / 3) ≙ Overvoltage category III / Pollution degree 3

**Connection data**

Connection technology	CAGE CLAMP®
Actuation type	Operating tool
Connectable conductor materials	Copper Aluminum
Solid conductor	0,08 ... 2,5 mm <sup>2</sup> / 28 ... 12 AWG
Fine-stranded conductor	0,08 ... 2,5 mm <sup>2</sup> / 28 ... 12 AWG
Strip length	8 ... 9 mm / 0.31 ... 0.35 inch
Total number of connection points	4
Total number of potentials	2
Number of levels	1
Wiring type	Front-entry wiring
Note (conductor cross-section)	12 AWG: THHN, THWN

**Geometrical Data**

Width	5 mm / 0.197 inch
Height from upper-edge of DIN-rail	28 mm / 1.102 inch
Depth	75 mm / 2.953 inch

**Mechanical data**

Design	horizontal
Mounting type	DIN-35 rail
Marking level	Center marking

**Material Data**

Color	gray
-------	------

Supus modificărilor.



Insulation material	Polyamide 66 (PA 66)
Fire load	0,149 MJ
Weight	9,1 g

### Commercial data



Product Group	1 (Rail Mounted Terminal Blocks)
Packaging type	BOX
Country of origin	DE
GTIN	4044918556842
Customs tariff number	85369010000

### Aprobări / certificate

#### Country specific Approvals

Emblemă	Aprobare	Text de aprobare suplimentar	Nume certificat
	<b>CCA</b> DEKRA Certification B.V.	EN 60947	2157201.01
	<b>CSA</b> DEKRA Certification B.V.	C22.2	1536071

#### Ship Approvals

Emblemă	Aprobare	Text de aprobare suplimentar	Nume certificat
	<b>ABS</b> American Bureau of Shipping	EN 60947	20-HG1941090-PDA
	<b>BV</b> Bureau Veritas S.A.	EN 60947	07436/E0 BV
	<b>DNV GL</b> Det Norske Veritas, Germanischer Lloyd	-	TAE00001V2
	<b>LR</b> Lloyds Register	EN 60947	91/20112 (E9)

Supus modificărilor.



## UL-Approvals

Emblemă	Aprobare	Text de aprobare suplimentar	Nume certificat
	UL Underwriters Laboratories Inc.	UL 1059	20170731- E45172





## Counterpart

## Produse compatibile

## Protective Warning Marker

	<b>Nr. articol: 280-415</b> Protective warning marker; with high-voltage symbol, black; for 5 terminal blocks; yellow	<a href="http://www.wago.com/280-415">www.wago.com/280-415</a>
--	--	--













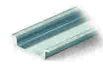

## Jumper

	<b>Nr. articol: 210-103</b> Wire commoning chain; insulated; 50 connections; black	<a href="http://www.wago.com/210-103">www.wago.com/210-103</a>
	<b>Nr. articol: 210-123</b> Wire commoning chain; insulated; 50 connections	<a href="http://www.wago.com/210-123">www.wago.com/210-123</a>
	<b>Nr. articol: 280-482</b> Comb-style jumper bar; insulated; 2-way; IN = IN terminal block; gray	<a href="http://www.wago.com/280-482">www.wago.com/280-482</a>
	<b>Nr. articol: 280-483</b> Comb-style jumper bar; insulated; 3-way; IN = IN terminal block; gray	<a href="http://www.wago.com/280-483">www.wago.com/280-483</a>
	<b>Nr. articol: 280-484</b> Comb-style jumper bar; insulated; 4-way; IN = IN terminal block; gray	<a href="http://www.wago.com/280-484">www.wago.com/280-484</a>

Supus modificărilor.

WAGO Kontakttechnik GmbH & Co. KG  
/Representative Office Romania  
Sos. Pipera-Tunari nr. 1/1  
building 1, 2nd floor | 077190 Voluntari, Ilfov  
Tel.: +40-(0)31 421 85 68 | Email: info-RO@wago.com

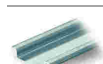
Aveți întrebări despre produsele noastre?  
Vă stăm la dispoziție pentru preluarea apelului la +40 (0) 31 421 85 68.

	<b>Nr. articol: 280-485</b> Comb-style jumper bar; insulated; 5-way; IN = IN terminal block; gray	<a href="http://www.wago.com/280-485">www.wago.com/280-485</a>
	<b>Nr. articol: 280-490</b> Comb-style jumper bar; insulated; 10-way; IN = IN terminal block; gray	<a href="http://www.wago.com/280-490">www.wago.com/280-490</a>
	<b>Nr. articol: 280-492</b> Alternate comb-style jumper bar; insulated; 2-way; IN = IN terminal block; gray	<a href="http://www.wago.com/280-492">www.wago.com/280-492</a>
	<b>Nr. articol: 709-110</b> Wire commoning chain; insulated; 4 connections; 3 x 110 mm; black	<a href="http://www.wago.com/709-110">www.wago.com/709-110</a>
	<b>Nr. articol: 709-111</b> Wire commoning chain; insulated; 3 connections; 2 x 120 mm; black	<a href="http://www.wago.com/709-111">www.wago.com/709-111</a>
	<b>Nr. articol: 709-112</b> Wire commoning chain; insulated; 3 connections; 2 x 170 mm; black	<a href="http://www.wago.com/709-112">www.wago.com/709-112</a>
<b>Carrier rail</b>		
	<b>Nr. articol: 210-112</b> Steel carrier rail; 35 x 7.5 mm; 1 mm thick; 2 m long; slotted; according to EN 60715; "Hole width 25 mm	<a href="http://www.wago.com/210-112">www.wago.com/210-112</a>
	<b>Nr. articol: 210-113</b> Steel carrier rail; 35 x 7.5 mm; 1 mm thick; 2 m long; unslotted; according to EN 60715	<a href="http://www.wago.com/210-113">www.wago.com/210-113</a>
	<b>Nr. articol: 210-114</b> Steel carrier rail; 35 x 15 mm; 1.5 mm thick; 2 m long; unslotted; similar to EN 60715	<a href="http://www.wago.com/210-114">www.wago.com/210-114</a>
	<b>Nr. articol: 210-115</b> Steel carrier rail; 35 x 7.5 mm; 1 mm thick; 2 m long; slotted; according to EN 60715; "Hole width 18 mm	<a href="http://www.wago.com/210-115">www.wago.com/210-115</a>
	<b>Nr. articol: 210-118</b> Steel carrier rail; 35 x 15 mm; 2.3 mm thick; 2 m long; unslotted; according to EN 60715	<a href="http://www.wago.com/210-118">www.wago.com/210-118</a>
	<b>Nr. articol: 210-196</b> Aluminum carrier rail; 35 x 8.2 mm; 1.6 mm thick; 2 m long; unslotted; similar to EN 60715; silver-colored	<a href="http://www.wago.com/210-196">www.wago.com/210-196</a>
	<b>Nr. articol: 210-197</b> Steel carrier rail; 35 x 15 mm; 1.5 mm thick; 2 m long; slotted; similar to EN 60715	<a href="http://www.wago.com/210-197">www.wago.com/210-197</a>
	<b>Nr. articol: 210-198</b> Copper carrier rail; 35 x 15 mm; 2.3 mm thick; 2 m long; unslotted; according to EN 60715; copper-colored	<a href="http://www.wago.com/210-198">www.wago.com/210-198</a>
	<b>Nr. articol: 210-504</b> Steel carrier rail; 35 x 7.5 mm; 1 mm thick; 2 m long; slotted; galvanized; according to EN 60715	<a href="http://www.wago.com/210-504">www.wago.com/210-504</a>
	<b>Nr. articol: 210-505</b> Steel carrier rail; 35 x 7.5 mm; 1 mm thick; 2 m long; unslotted; galvanized; according to EN 60715	<a href="http://www.wago.com/210-505">www.wago.com/210-505</a>
	<b>Nr. articol: 210-506</b> Steel carrier rail; 35 x 15 mm; 1.5 mm thick; 2 m long; unslotted; galvanized; similar to EN 60715	<a href="http://www.wago.com/210-506">www.wago.com/210-506</a>

Supus modificărilor.

WAGO Kontakttechnik GmbH & Co. KG  
/Representative Office Romania  
Sos. Pipera-Tunari nr. 1/1  
building 1, 2nd floor | 077190 Voluntari, Ilfov  
Tel.: +40-(0)31 421 85 68 | Email: info-RO@wago.com

Aveți întrebări despre produsele noastre?  
Vă stăm la dispoziție pentru preluarea apelului la +40 (0) 31 421 85 68.

**Nr. articol: 210-508**

Steel carrier rail; 35 x 15 mm; 1.5 mm thick; 2 m long; slotted; galvanized; similar to EN 60715

[www.wago.com/210-508](http://www.wago.com/210-508)**Insulation stop****Nr. articol: 280-470**Insulation stop; 0.08 - 0.2 mm<sup>2</sup> "s" (0.14 mm<sup>2</sup> "f-st"); 5 pieces/strip; white[www.wago.com/280-470](http://www.wago.com/280-470)**Nr. articol: 280-471**Insulation stop; 0.25 - 0.5 mm<sup>2</sup>; 5 pieces/strip; light gray[www.wago.com/280-471](http://www.wago.com/280-471)**Nr. articol: 280-472**Insulation stop; 0.75 - 1 mm<sup>2</sup>; 5 pieces/strip[www.wago.com/280-472](http://www.wago.com/280-472)**End plate****Nr. articol: 280-314**

End and intermediate plate; 2.5 mm thick; gray

[www.wago.com/280-314](http://www.wago.com/280-314)**Nr. articol: 280-315**

End and intermediate plate; 2.5 mm thick; orange

[www.wago.com/280-315](http://www.wago.com/280-315)**Nr. articol: 280-334**

Separator plate; 2 mm thick; oversized; gray

[www.wago.com/280-334](http://www.wago.com/280-334)**Nr. articol: 280-335**

Separator plate; 2 mm thick; oversized; orange

[www.wago.com/280-335](http://www.wago.com/280-335)**plug****Nr. articol: 280-801**

Empty component plug housing; gray

[www.wago.com/280-801](http://www.wago.com/280-801)**Nr. articol: 280-801/281-411**

Component plug; for carrier terminal blocks; 2-pole; with diode 1N4007; 5 mm wide; gray

[www.wago.com/280-801/281-411](http://www.wago.com/280-801/281-411)**Nr. articol: 280-801/281-413**

Component plug; for carrier terminal blocks; 1-pole; LED (red); 24 VDC; 5 mm wide; gray

[www.wago.com/280-801/281-413](http://www.wago.com/280-801/281-413)**Nr. articol: 280-801/281-414**

Component plug; for carrier terminal blocks; 1-pole; LED (red); 48 VDC; 5 mm wide; gray

[www.wago.com/280-801/281-414](http://www.wago.com/280-801/281-414)**Nr. articol: 280-801/281-415**

Component plug; for carrier terminal blocks; 1-pole; LED (red); 5 mm wide; gray

[www.wago.com/280-801/281-415](http://www.wago.com/280-801/281-415)**Nr. articol: 280-801/281-416**















Component plug; for carrier terminal blocks; 1-pole; LED (red); 5 mm wide; gray

[www.wago.com/280-801/281-416](http://www.wago.com/280-801/281-416)**Nr. articol: 280-801/281-417**















Component plug; for carrier terminal blocks; 1-pole; 5 mm wide; gray

[www.wago.com/280-801/281-417](http://www.wago.com/280-801/281-417)

Supus modificărilor.













	<b>Nr. articol: 280-801/281-418</b> Component plug; for carrier terminal blocks; 1-pole; 5 mm wide; gray	<a href="http://www.wago.com/280-801/281-418">www.wago.com/280-801/281-418</a>
	<b>Nr. articol: 280-801/281-420</b> Component plug; for carrier terminal blocks; 2-pole; with LED and recovery diode; 5 mm wide; gray	<a href="http://www.wago.com/280-801/281-420">www.wago.com/280-801/281-420</a>
	<b>Nr. articol: 280-801/281-421</b> Component plug; for carrier terminal blocks; 2-pole; with LED and recovery diode; 5 mm wide; gray	<a href="http://www.wago.com/280-801/281-421">www.wago.com/280-801/281-421</a>
	<b>Nr. articol: 280-850</b> Fuse plug; with soldered miniature fuse; 250 mA FF; 5 mm wide; gray	<a href="http://www.wago.com/280-850">www.wago.com/280-850</a>
	<b>Nr. articol: 280-850/281-413</b> Fuse plug; with soldered miniature fuse; with indicator lamp; LED (red); DC 15 - 30 V; 250 mA FF; 5 mm wide; gray	<a href="http://www.wago.com/280-850/281-413">www.wago.com/280-850/281-413</a>
	<b>Nr. articol: 280-850/281-414</b> Fuse plug; with soldered miniature fuse; with indicator lamp; LED (red); DC 30 - 65 V; 250 mA FF; 5 mm wide; gray	<a href="http://www.wago.com/280-850/281-414">www.wago.com/280-850/281-414</a>
	<b>Nr. articol: 280-850/281-415</b> Fuse plug; with soldered miniature fuse; with indicator lamp; LED (red); AC 15 - 30 V; 250 mA FF; 5 mm wide; gray	<a href="http://www.wago.com/280-850/281-415">www.wago.com/280-850/281-415</a>
	<b>Nr. articol: 280-852</b> Fuse plug; with soldered miniature fuse; 500 mA FF; 5 mm wide; gray	<a href="http://www.wago.com/280-852">www.wago.com/280-852</a>
	<b>Nr. articol: 280-852/281-413</b> Fuse plug; with soldered miniature fuse; with indicator lamp; LED (red); DC 15 - 30 V; 500 mA FF; 5 mm wide; gray	<a href="http://www.wago.com/280-852/281-413">www.wago.com/280-852/281-413</a>
	<b>Nr. articol: 280-852/281-414</b> Fuse plug; with soldered miniature fuse; with indicator lamp; LED (red); DC 30 - 65 V; 500 mA FF; 5 mm wide; gray	<a href="http://www.wago.com/280-852/281-414">www.wago.com/280-852/281-414</a>
	<b>Nr. articol: 280-852/281-415</b> Fuse plug; with soldered miniature fuse; with indicator lamp; LED (red); AC 15 - 30 V; 500 mA FF; 5 mm wide; gray	<a href="http://www.wago.com/280-852/281-415">www.wago.com/280-852/281-415</a>
	<b>Nr. articol: 280-854</b> Fuse plug; with soldered miniature fuse; 1 A FF; 5 mm wide; gray	<a href="http://www.wago.com/280-854">www.wago.com/280-854</a>
	<b>Nr. articol: 280-854/281-413</b> Fuse plug; with soldered miniature fuse; with indicator lamp; LED (red); DC 15 - 30 V; 1 A FF; 5 mm wide; gray	<a href="http://www.wago.com/280-854/281-413">www.wago.com/280-854/281-413</a>
	<b>Nr. articol: 280-854/281-414</b> Fuse plug; with soldered miniature fuse; with indicator lamp; LED (red); DC 30 - 65 V; 1 A FF; 5 mm wide; gray	<a href="http://www.wago.com/280-854/281-414">www.wago.com/280-854/281-414</a>

Supus modificărilor.











	<b>Nr. articol: 280-854/281-415</b> Fuse plug; with soldered miniature fuse; with indicator lamp; LED (red); AC 15 - 30 V; 1 A FF; 5 mm wide; gray	<a href="http://www.wago.com/280-854/281-415">www.wago.com/280-854/281-415</a>
	<b>Nr. articol: 280-856</b> Fuse plug; with soldered miniature fuse; 2 A FF; 5 mm wide; gray	<a href="http://www.wago.com/280-856">www.wago.com/280-856</a>
	<b>Nr. articol: 280-856/281-413</b> Fuse plug; with soldered miniature fuse; with indicator lamp; LED (red); DC 15 - 30 V; 2 A FF; 5 mm wide; gray	<a href="http://www.wago.com/280-856/281-413">www.wago.com/280-856/281-413</a>
	<b>Nr. articol: 280-856/281-414</b> Fuse plug; with soldered miniature fuse; with indicator lamp; LED (red); DC 30 - 65 V; 2 A FF; 5 mm wide; gray	<a href="http://www.wago.com/280-856/281-414">www.wago.com/280-856/281-414</a>
	<b>Nr. articol: 280-856/281-415</b> Fuse plug; with soldered miniature fuse; with indicator lamp; LED (red); AC 15 - 30 V; 2 A FF; 5 mm wide; gray	<a href="http://www.wago.com/280-856/281-415">www.wago.com/280-856/281-415</a>
<b>General accessories</b>		
	<b>Nr. articol: 280-802</b> Empty component plug housing; gray	<a href="http://www.wago.com/280-802">www.wago.com/280-802</a>
	<b>Nr. articol: 280-804</b> Empty component plug housing; 10 mm wide; Type 3; 4-pole; gray	<a href="http://www.wago.com/280-804">www.wago.com/280-804</a>
	<b>Nr. articol: 286-110</b> Empty component plug housing; Type 9; 10 mm wide; 4-pole; gray	<a href="http://www.wago.com/286-110">www.wago.com/286-110</a>
	<b>Nr. articol: 286-111</b> Empty component plug housing; Type 10; 15 mm wide; 6-pole; gray	<a href="http://www.wago.com/286-111">www.wago.com/286-111</a>
	<b>Nr. articol: 286-112</b> Empty component plug housing; Type 11; 20 mm wide; 8-pole; gray	<a href="http://www.wago.com/286-112">www.wago.com/286-112</a>
	<b>Nr. articol: 286-113</b> Empty component plug housing; Type 12; 25 mm wide; 10-pole; gray	<a href="http://www.wago.com/286-113">www.wago.com/286-113</a>
	<b>Nr. articol: 286-304</b> Relay module; Nominal input voltage: 24 VDC; 1 changeover contact; Limiting continuous current: 7 A; Red status indicator; Module width: 15 mm; gray	<a href="http://www.wago.com/286-304">www.wago.com/286-304</a>
	<b>Nr. articol: 286-304/004-000</b> Relay module; Nominal input voltage: 24 VDC; 1 changeover contact; Limiting continuous current: 7 A; Path; Red status indicator; Module width: 15 mm; gray	<a href="http://www.wago.com/286-304/004-000">www.wago.com/286-304/004-000</a>
	<b>Nr. articol: 286-307/004-000</b> Relay module; Nominal input voltage: 110 VDC; 1 changeover contact; Limiting continuous current: 7 A; Path; Red status indicator; Module width: 15 mm; gray	<a href="http://www.wago.com/286-307/004-000">www.wago.com/286-307/004-000</a>
	<b>Nr. articol: 286-312</b> Relay module; Relay with 2 changeover contacts (2u); gray	<a href="http://www.wago.com/286-312">www.wago.com/286-312</a>

Supus modificărilor.

















	<b>Nr. articol: 286-312/004-000</b> Relay module; Nominal input voltage: 24 VDC; 2 changeover contacts; Limiting continuous current: 5 A; Path; Red status indicator; Module width: 20 mm; gray	<a href="http://www.wago.com/286-312/004-000">www.wago.com/286-312/004-000</a>
	<b>Nr. articol: 286-316</b> Relay module; Nominal input voltage: 220 VDC; 2 changeover contacts; Limiting continuous current: 7 A; Red status indicator; Module width: 20 mm; gray	<a href="http://www.wago.com/286-316">www.wago.com/286-316</a>
	<b>Nr. articol: 286-320</b> Relay module; Nominal input voltage: 24 VDC; 1 break and 1 make contact; Limiting continuous current: 6 A; Red status indicator; Module width: 20 mm; gray	<a href="http://www.wago.com/286-320">www.wago.com/286-320</a>
	<b>Nr. articol: 286-320/004-000</b> Relay module; Nominal input voltage: 24 VDC; 1 break and 1 make contact; Path; Red status indicator; Module width: 20 mm; gray	<a href="http://www.wago.com/286-320/004-000">www.wago.com/286-320/004-000</a>
	<b>Nr. articol: 286-328</b> Relay module; Nominal input voltage: 24 VDC; 2 make contact; Limiting continuous current: 6 A; Red status indicator; Module width: 20 mm; gray	<a href="http://www.wago.com/286-328">www.wago.com/286-328</a>
	<b>Nr. articol: 286-328/004-000</b> Relay module; Nominal input voltage: 24 VDC; 2 make contact; Limiting continuous current: 6 A; Path; Red status indicator; Module width: 20 mm; gray	<a href="http://www.wago.com/286-328/004-000">www.wago.com/286-328/004-000</a>
	<b>Nr. articol: 286-336/001-000</b> Relay module; Nominal input voltage: 24 VDC; 2 break and 2 make contacts; Red status indicator; Module width: 25 mm; gray	<a href="http://www.wago.com/286-336/001-000">www.wago.com/286-336/001-000</a>
	<b>Nr. articol: 286-344/004-000</b> Relay module; Nominal input voltage: 24 VDC; 3 break contacts and 1 make contact; Path; Red status indicator; Module width: 25 mm; gray	<a href="http://www.wago.com/286-344/004-000">www.wago.com/286-344/004-000</a>
	<b>Nr. articol: 286-352/004-000</b> Relay module; Nominal input voltage: 24 VDC; 4 make contacts; Limiting continuous current: 5 A; Path; Red status indicator; Module width: 25 mm; gray	<a href="http://www.wago.com/286-352/004-000">www.wago.com/286-352/004-000</a>
	<b>Nr. articol: 286-364</b> Relay module; Nominal input voltage: 24 VDC; 1 make contact; Limiting continuous current: 5 A; Red status indicator; Module width: 10 mm; gray	<a href="http://www.wago.com/286-364">www.wago.com/286-364</a>
	<b>Nr. articol: 286-364/004-000</b> Relay module; Nominal input voltage: 24 VDC; 1 make contact; Path; Red status indicator; Module width: 10 mm; gray	<a href="http://www.wago.com/286-364/004-000">www.wago.com/286-364/004-000</a>
	<b>Nr. articol: 286-368</b> Relay module; Nominal input voltage: 24 VDC; 1 break contact; Limiting continuous current: 5 A; Red status indicator; Module width: 10 mm; gray	<a href="http://www.wago.com/286-368">www.wago.com/286-368</a>
	<b>Nr. articol: 286-368/004-000</b> Relay module; Nominal input voltage: 24 VDC; 1 break contact; Path; Red status indicator; Module width: 10 mm	<a href="http://www.wago.com/286-368/004-000">www.wago.com/286-368/004-000</a>
	<b>Nr. articol: 286-376</b> Relay module; Nominal input voltage: 24 VDC; 1 make contact; Limiting continuous current: 5 A; for switching higher DC loads; Red status indicator; Module width: 15 mm; gray	<a href="http://www.wago.com/286-376">www.wago.com/286-376</a>
	<b>Nr. articol: 286-380</b>	

















Supus modificărilor.

	Bistable relay module; Nominal input voltage: 24 VDC; 1 changeover contact; Limiting continuous current: 6 A; Red status indicator; Module width: 15 mm; gray	<a href="http://www.wago.com/286-380">www.wago.com/286-380</a>
	<b>Nr. articol: 286-381</b> Bistable relay module; Nominal input voltage: 24 VDC; 1 changeover contact; Limiting continuous current: 6 A; Red status indicator; Module width: 15 mm; gray	<a href="http://www.wago.com/286-381">www.wago.com/286-381</a>
	<b>Nr. articol: 286-394/004-000</b> Relay module; Nominal input voltage: 24 VDC; 1 changeover contact; Path; Red status indicator; Module width: 15 mm; light gray	<a href="http://www.wago.com/286-394/004-000">www.wago.com/286-394/004-000</a>
	<b>Nr. articol: 286-427</b> Timer relay module; Nominal input voltage: 24 VDC; Limiting continuous current: 5 A; Pulse lengthening: 1 ... 10 s; Red status indicator; Module width: 20 mm; gray	<a href="http://www.wago.com/286-427">www.wago.com/286-427</a>
	<b>Nr. articol: 286-507</b> Relay module; Nominal input voltage: 115 VAC; 1 changeover contact; Limiting continuous current: 7 A; Red status indicator; Module width: 15 mm; gray	<a href="http://www.wago.com/286-507">www.wago.com/286-507</a>
	<b>Nr. articol: 286-508</b> Relay module; Nominal input voltage: 230 VAC; 1 changeover contact; Limiting continuous current: 7 A; Red status indicator; Module width: 15 mm; gray	<a href="http://www.wago.com/286-508">www.wago.com/286-508</a>
	<b>Nr. articol: 286-516</b> Relay module; Nominal input voltage: 230 VAC; 2 changeover contacts; Limiting continuous current: 7 A; Red status indicator; Module width: 15 mm; gray	<a href="http://www.wago.com/286-516">www.wago.com/286-516</a>
	<b>Nr. articol: 286-573</b> Latching relay module; Nominal input voltage: 24 VDC; 1 changeover contact; Limiting continuous current: 6 A; Red status indicator; Module width: 15 mm	<a href="http://www.wago.com/286-573">www.wago.com/286-573</a>
	<b>Nr. articol: 286-575</b> Latching relay module; Nominal input voltage: 24 VDC; 1 changeover contact; Limiting continuous current: 3 A; Path; Red status indicator; Module width: 22 mm	<a href="http://www.wago.com/286-575">www.wago.com/286-575</a>
	<b>Nr. articol: 286-604/004-000</b> Timer relay module; Nominal input voltage: 24 VDC; Limiting continuous current: 6 A; On-delay: 10 ... 100 s; Red status indicator; Module width: 20 mm; gray	<a href="http://www.wago.com/286-604/004-000">www.wago.com/286-604/004-000</a>
	<b>Nr. articol: 286-640</b> Timer relay module; Nominal input voltage: 24 VDC; Limiting continuous current: 6 A; Path; Multifunction/Multitime; Yellow status indicator; Module width: 6 mm; gray	<a href="http://www.wago.com/286-640">www.wago.com/286-640</a>
	<b>Nr. articol: 286-640/004-000</b> Multifunction timing relay module; Relay with 1 changeover contact (1u); 4 time ranges; for railway operations; 4 functions; gray	<a href="http://www.wago.com/286-640/004-000">www.wago.com/286-640/004-000</a>
	<b>Nr. articol: 286-661</b> Current flow monitoring module; AC currents; adjustable; light gray	<a href="http://www.wago.com/286-661">www.wago.com/286-661</a>
	<b>Nr. articol: 286-662</b> Current flow monitoring module; DC currents; Monitoring range: 0.4 A – 3.5 A; 1 make contact; light gray	<a href="http://www.wago.com/286-662">www.wago.com/286-662</a>
	<b>Nr. articol: 286-664</b> Current flow monitoring module; AC currents; Monitoring range: 1 A – 10 A; 1 changeover contact; light gray	<a href="http://www.wago.com/286-664">www.wago.com/286-664</a>
	<b>Nr. articol: 286-665</b>	

















Supus modificărilor.

	Current flow monitoring module; AC currents; Monitoring range: 1 A – 10 A; 1 changeover contact; light gray	<a href="http://www.wago.com/286-665">www.wago.com/286-665</a>
	<b>Nr. articol: 286-721</b> Optocoupler module; Nominal input voltage: 24 VDC; Output voltage range: 15 ... 30 VDC; Limiting continuous current: 5 A; 3-wire connection/low-side switching; Red status indicator; Module width: 15 mm; gray	<a href="http://www.wago.com/286-721">www.wago.com/286-721</a>
	<b>Nr. articol: 286-723</b> Optocoupler module; Nominal input voltage: 24 VDC; Output voltage range: 15 ... 30 VDC; Limiting continuous current: 4 A; 3-wire connection/high-side switching; Red status indicator; Module width: 15 mm; gray	<a href="http://www.wago.com/286-723">www.wago.com/286-723</a>
	<b>Nr. articol: 286-725</b> Optocoupler module; Input AC/DC 10 V ... 30 V; Output DC 24 V/ 1 mA ... 0.5 A; negative switching; gray	<a href="http://www.wago.com/286-725">www.wago.com/286-725</a>
	<b>Nr. articol: 286-742</b> S0 interface power supply; Input voltage: 230 VAC; S0 interface	<a href="http://www.wago.com/286-742">www.wago.com/286-742</a>
	<b>Nr. articol: 286-752</b> Optocoupler module; Nominal input voltage: 24 VDC; Output voltage range: 20 ... 30 VDC; Limiting continuous current: 0.5 A; 3-wire connection/high-side switching; Frequency: 25 kHz; Red status indicator; Module width: 15 mm; gray	<a href="http://www.wago.com/286-752">www.wago.com/286-752</a>
	<b>Nr. articol: 286-752/002-000</b> Optocoupler module; Red status indicator; gray	<a href="http://www.wago.com/286-752/002-000">www.wago.com/286-752/002-000</a>
	<b>Nr. articol: 286-790</b> Optocoupler module; gray	<a href="http://www.wago.com/286-790">www.wago.com/286-790</a>
	<b>Nr. articol: 286-791</b> Optocoupler module; Nominal input voltage: 24 VDC; Output voltage range: 20 ... 60 VDC; Limiting continuous current: 0.1 A; 2-wire connection; Frequency: 3 kHz; Red status indicator; Module width: 10 mm; gray	<a href="http://www.wago.com/286-791">www.wago.com/286-791</a>
	<b>Nr. articol: 286-792</b> Optocoupler module; Red status indicator; gray	<a href="http://www.wago.com/286-792">www.wago.com/286-792</a>
	<b>Nr. articol: 286-794</b> Optocoupler module; Nominal input voltage: 24 VDC; Output voltage range: 20 ... 60 VDC; Limiting continuous current: 0.1 A; 2-wire connection; Red status indicator; Module width: 10 mm; gray	<a href="http://www.wago.com/286-794">www.wago.com/286-794</a>
	<b>Nr. articol: 286-797</b> Optocoupler module; Red status indicator	<a href="http://www.wago.com/286-797">www.wago.com/286-797</a>
	<b>Nr. articol: 286-803</b> Component module with diode; gray	<a href="http://www.wago.com/286-803">www.wago.com/286-803</a>
	<b>Nr. articol: 286-805</b> Component module with diode; light gray	<a href="http://www.wago.com/286-805">www.wago.com/286-805</a>
	<b>Nr. articol: 286-807</b> Component module with diode; with 7 pcs; Diode 1N4007; with common anode; light gray	<a href="http://www.wago.com/286-807">www.wago.com/286-807</a>
	<b>Nr. articol: 286-809</b>	















Supus modificărilor.

	Component module with diode; light gray	<a href="http://www.wago.com/286-809">www.wago.com/286-809</a>
	<b>Nr. articol: 286-822</b> Component module with LED; Red LED; with common cathode	<a href="http://www.wago.com/286-822">www.wago.com/286-822</a>
	<b>Nr. articol: 286-826</b> AND gate module with 6 inputs; light gray	<a href="http://www.wago.com/286-826">www.wago.com/286-826</a>
	<b>Nr. articol: 286-830</b> Bridge rectifier module; Input voltage: 24 VAC; with varistor protective circuit; gray	<a href="http://www.wago.com/286-830">www.wago.com/286-830</a>
	<b>Nr. articol: 286-831</b> Surge suppression module for signal technology; Nominal voltage: 24 VAC/DC; for 2 signal paths with common surge arrester; plugged on rail-mount terminal block, 15 mm wide; gray	<a href="http://www.wago.com/286-831">www.wago.com/286-831</a>
	<b>Nr. articol: 286-832</b> Surge suppression module for signal technology; Nominal voltage: 24 VAC/DC; for 2 signal paths with common surge arrester; pluggable on rail-mount terminal block, 20 mm wide; gray	<a href="http://www.wago.com/286-832">www.wago.com/286-832</a>
	<b>Nr. articol: 286-833</b> Surge suppression module for signal technology; Nominal voltage: 24 VDC; for 1 signal path; plugged on rail-mount terminal block, 15 mm wide; gray	<a href="http://www.wago.com/286-833">www.wago.com/286-833</a>
	<b>Nr. articol: 286-834</b> Surge suppression module for signal technology; Nominal voltage: 12 VDC; for 2 signal paths with common surge arrester; pluggable on rail-mount terminal block, 20 mm wide; gray	<a href="http://www.wago.com/286-834">www.wago.com/286-834</a>
	<b>Nr. articol: 286-834/024-000</b> Surge suppression module for signal technology; Nominal voltage: 24 VDC; for 2 signal paths with common surge arrester; pluggable on rail-mount terminal block, 15 mm wide; gray	<a href="http://www.wago.com/286-834/024-000">www.wago.com/286-834/024-000</a>
	<b>Nr. articol: 286-835</b> Surge suppression module for signal technology; Nominal voltage: 230 VAC; for 2 signal paths with common surge arrester; plugged on rail-mount terminal block, 15 mm wide	<a href="http://www.wago.com/286-835">www.wago.com/286-835</a>
	<b>Nr. articol: 286-835/115-000</b> Surge suppression module for signal technology; Nominal voltage: 115 VAC; for 2 signal paths with common surge arrester; plugged on rail-mount terminal block, 15 mm wide; gray	<a href="http://www.wago.com/286-835/115-000">www.wago.com/286-835/115-000</a>
	<b>Nr. articol: 286-836</b> Surge suppression module for signal technology; Nominal voltage: 24 VAC/DC; for 2 signal paths with common surge arrester; plugged on rail-mount terminal block, 15 mm wide; gray	<a href="http://www.wago.com/286-836">www.wago.com/286-836</a>
	<b>Nr. articol: 286-838</b> Surge suppression module for signal technology; Nominal voltage: 230 VAC; for 2 signal paths with common surge arrester; with visual indicator; gray	<a href="http://www.wago.com/286-838">www.wago.com/286-838</a>
	<b>Nr. articol: 286-840</b> Bridge rectifier module; Input voltage: 250 VAC; with varistor protective circuit; gray	<a href="http://www.wago.com/286-840">www.wago.com/286-840</a>
	<b>Nr. articol: 286-841</b> Surge suppression module for signal technology; Nominal voltage: 220 VDC; for 2 signal paths with common surge arrester; pluggable on rail-mount terminal block, 25 mm wide; gray	<a href="http://www.wago.com/286-841">www.wago.com/286-841</a>
	<b>Nr. articol: 286-842</b> Surge suppression module for signal technology; Nominal voltage: 230 VAC; for 2 signal paths with common surge arrester; pluggable on rail-mount terminal block, 25 mm wide; gray	<a href="http://www.wago.com/286-842">www.wago.com/286-842</a>

Supus modificărilor.

	<b>Nr. articol: 286-843</b> Surge suppression module for signal technology; Nominal voltage: 115 VAC; for 2 signal paths with common surge arrester; pluggable on rail-mount terminal block, 25 mm wide; gray	<a href="http://www.wago.com/286-843">www.wago.com/286-843</a>
	<b>Nr. articol: 286-844</b> Surge suppression module for signal technology; for 2 signal paths with common surge arrester; pluggable on rail-mount terminal block, 25 mm wide; gray	<a href="http://www.wago.com/286-844">www.wago.com/286-844</a>
	<b>Nr. articol: 286-890</b> Component module with fuse; for (5 x 20) mm microfuse; Nominal voltage: 24 VAC/DC; gray	<a href="http://www.wago.com/286-890">www.wago.com/286-890</a>
	<b>Nr. articol: 286-891</b> Component module with fuse; for (5 x 20) mm microfuse; Nominal voltage: 230 VAC/DC; gray	<a href="http://www.wago.com/286-891">www.wago.com/286-891</a>
	<b>Nr. articol: 286-895</b> Switching module; with changeover rocker switch; Switching voltage: 250 VAC; Switching current: 6 A; gray	<a href="http://www.wago.com/286-895">www.wago.com/286-895</a>
	<b>Nr. articol: 286-896</b> Switching module; with momentary switch; Switching voltage: 250 VAC; Switching current: 6 A; gray	<a href="http://www.wago.com/286-896">www.wago.com/286-896</a>
<b>assembling</b>		
	<b>Nr. articol: 209-106</b> Mounting carrier; for isolated mounting on DIN 35 rails; gray	<a href="http://www.wago.com/209-106">www.wago.com/209-106</a>
	<b>Nr. articol: 210-148</b> Angled support bracket; without screw	<a href="http://www.wago.com/210-148">www.wago.com/210-148</a>
<b>tools</b>		
	<b>Nr. articol: 210-657</b> Operating tool; Blade: 3.5 x 0.5 mm; with a partially insulated shaft; short	<a href="http://www.wago.com/210-657">www.wago.com/210-657</a>
	<b>Nr. articol: 210-658</b> Operating tool; Blade: 3.5 x 0.5 mm; with a partially insulated shaft; angled; short	<a href="http://www.wago.com/210-658">www.wago.com/210-658</a>
	<b>Nr. articol: 210-720</b> Operating tool; Blade: 3.5 x 0.5 mm; with a partially insulated shaft	<a href="http://www.wago.com/210-720">www.wago.com/210-720</a>
<b>ferrule</b>		
	<b>Nr. articol: 216-101</b> Ferrule; Sleeve for 0.5 mm <sup>2</sup> / AWG 22; uninsulated; electro-tin plated	<a href="http://www.wago.com/216-101">www.wago.com/216-101</a>
	<b>Nr. articol: 216-102</b> Ferrule; Sleeve for 0.75 mm <sup>2</sup> / AWG 20; uninsulated; electro-tin plated	<a href="http://www.wago.com/216-102">www.wago.com/216-102</a>
	<b>Nr. articol: 216-103</b> Ferrule; Sleeve for 1 mm <sup>2</sup> / AWG 18; uninsulated; electro-tin plated	<a href="http://www.wago.com/216-103">www.wago.com/216-103</a>
	<b>Nr. articol: 216-104</b> Ferrule; Sleeve for 1.5 mm <sup>2</sup> / AWG 16; uninsulated; electro-tin plated	<a href="http://www.wago.com/216-104">www.wago.com/216-104</a>
	<b>Nr. articol: 216-201</b> Ferrule; Sleeve for 0.5 mm <sup>2</sup> / 20 AWG; insulated; electro-tin plated; white	<a href="http://www.wago.com/216-201">www.wago.com/216-201</a>
	<b>Nr. articol: 216-202</b>	

Supus modificărilor.

	Ferrule; Sleeve for 0.75 mm <sup>2</sup> / 18 AWG; insulated; electro-tin plated; gray	<a href="http://www.wago.com/216-202">www.wago.com/216-202</a>
	<b>Nr. articol: 216-203</b> Ferrule; Sleeve for 1 mm <sup>2</sup> / AWG 18; insulated; electro-tin plated; red	<a href="http://www.wago.com/216-203">www.wago.com/216-203</a>
	<b>Nr. articol: 216-204</b> Ferrule; Sleeve for 1.5 mm <sup>2</sup> / AWG 16; insulated; electro-tin plated; black	<a href="http://www.wago.com/216-204">www.wago.com/216-204</a>
	<b>Nr. articol: 216-301</b> Ferrule; Sleeve for 0.25 mm <sup>2</sup> / AWG 24; insulated; electro-tin plated; yellow	<a href="http://www.wago.com/216-301">www.wago.com/216-301</a>
	<b>Nr. articol: 216-302</b> Ferrule; Sleeve for 0.34 mm <sup>2</sup> / 22 AWG; insulated; electro-tin plated; green	<a href="http://www.wago.com/216-302">www.wago.com/216-302</a>
<b>Marking accessories</b>		
	<b>Nr. articol: 2009-115</b> WMB-Inline; for Smart Printer; 1500 pieces on roll; stretchable 5 - 5.2 mm; plain; snap-on type; white	<a href="http://www.wago.com/2009-115">www.wago.com/2009-115</a>
	<b>Nr. articol: 2009-115/000-002</b> WMB-Inline; for Smart Printer; 1500 pieces on roll; stretchable 5 - 5.2 mm; plain; snap-on type; yellow	<a href="http://www.wago.com/2009-115/000-002">www.wago.com/2009-115/000-002</a>
	<b>Nr. articol: 2009-115/000-006</b> WMB-Inline; for Smart Printer; 1500 pieces on roll; stretchable 5 - 5.2 mm; plain; snap-on type; blue	<a href="http://www.wago.com/2009-115/000-006">www.wago.com/2009-115/000-006</a>
	<b>Nr. articol: 2009-115/000-007</b> WMB-Inline; for Smart Printer; 1500 pieces on roll; stretchable 5 - 5.2 mm; plain; snap-on type; gray	<a href="http://www.wago.com/2009-115/000-007">www.wago.com/2009-115/000-007</a>
	<b>Nr. articol: 2009-115/000-012</b> WMB-Inline; for Smart Printer; 1500 pieces on roll; stretchable 5 - 5.2 mm; plain; snap-on type; orange	<a href="http://www.wago.com/2009-115/000-012">www.wago.com/2009-115/000-012</a>
	<b>Nr. articol: 2009-115/000-017</b> WMB-Inline; for Smart Printer; 1500 pieces on roll; stretchable 5 - 5.2 mm; plain; snap-on type; light green	<a href="http://www.wago.com/2009-115/000-017">www.wago.com/2009-115/000-017</a>
	<b>Nr. articol: 2009-115/000-023</b> WMB-Inline; for Smart Printer; 1500 pieces on roll; stretchable 5 - 5.2 mm; plain; snap-on type; green	<a href="http://www.wago.com/2009-115/000-023">www.wago.com/2009-115/000-023</a>
	<b>Nr. articol: 2009-115/000-024</b> WMB-Inline; for Smart Printer; 1500 pieces on roll; stretchable 5 - 5.2 mm; plain; snap-on type; violet	<a href="http://www.wago.com/2009-115/000-024">www.wago.com/2009-115/000-024</a>
	<b>Nr. articol: 793-501</b> WMB marking card; as card; not stretchable; plain; snap-on type; white	<a href="http://www.wago.com/793-501">www.wago.com/793-501</a>
	<b>Nr. articol: 793-501/000-002</b> WMB marking card; as card; not stretchable; plain; snap-on type; yellow	<a href="http://www.wago.com/793-501/000-002">www.wago.com/793-501/000-002</a>

Supus modificărilor.



**Nr. articol: 793-501/000-005**  
WMB marking card; as card; not stretchable; plain; snap-on type; red

[www.wago.com/793-501/000-005](http://www.wago.com/793-501/000-005)



**Nr. articol: 793-501/000-006**  
WMB marking card; as card; not stretchable; plain; snap-on type; blue

[www.wago.com/793-501/000-006](http://www.wago.com/793-501/000-006)



**Nr. articol: 793-501/000-007**  
WMB marking card; as card; not stretchable; plain; snap-on type; gray

[www.wago.com/793-501/000-007](http://www.wago.com/793-501/000-007)



**Nr. articol: 793-501/000-012**  
WMB marking card; as card; not stretchable; plain; snap-on type; orange

[www.wago.com/793-501/000-012](http://www.wago.com/793-501/000-012)



**Nr. articol: 793-501/000-017**  
WMB marking card; as card; not stretchable; plain; snap-on type; light green

[www.wago.com/793-501/000-017](http://www.wago.com/793-501/000-017)



**Nr. articol: 793-501/000-023**  
WMB marking card; as card; not stretchable; plain; snap-on type; green

[www.wago.com/793-501/000-023](http://www.wago.com/793-501/000-023)



**Nr. articol: 793-501/000-024**  
WMB marking card; as card; not stretchable; plain; snap-on type; violet

[www.wago.com/793-501/000-024](http://www.wago.com/793-501/000-024)



**Nr. articol: 793-5501**  
WMB marking card; as card; for terminal block width 5 - 17.5 mm; stretchable 5 - 5.2 mm; plain; snap-on type; white

[www.wago.com/793-5501](http://www.wago.com/793-5501)



**Nr. articol: 793-5501/000-002**  
WMB marking card; as card; for terminal block width 5 - 17.5 mm; stretchable 5 - 5.2 mm; plain; snap-on type; yellow

[www.wago.com/793-5501/000-002](http://www.wago.com/793-5501/000-002)



**Nr. articol: 793-5501/000-005**  
WMB marking card; as card; for terminal block width 5 - 17.5 mm; stretchable 5 - 5.2 mm; plain; snap-on type; red

[www.wago.com/793-5501/000-005](http://www.wago.com/793-5501/000-005)



**Nr. articol: 793-5501/000-006**  
WMB marking card; as card; for terminal block width 5 - 17.5 mm; stretchable 5 - 5.2 mm; plain; snap-on type; blue

[www.wago.com/793-5501/000-006](http://www.wago.com/793-5501/000-006)



**Nr. articol: 793-5501/000-007**  
WMB marking card; as card; for terminal block width 5 - 17.5 mm; stretchable 5 - 5.2 mm; plain; snap-on type; gray

[www.wago.com/793-5501/000-007](http://www.wago.com/793-5501/000-007)



**Nr. articol: 793-5501/000-012**  
WMB marking card; as card; for terminal block width 5 - 17.5 mm; stretchable 5 - 5.2 mm; plain; snap-on type; orange

[www.wago.com/793-5501/000-012](http://www.wago.com/793-5501/000-012)

**Nr. articol: 793-5501/000-017**

Supus modificărilor.



WMB marking card; as card; for terminal block width 5 - 17.5 mm; stretchable 5 - 5.2 mm; plain; snap-on type; green

[www.wago.com/793-5501/000-017](http://www.wago.com/793-5501/000-017)



**Nr. articol: 793-5501/000-023**

WMB marking card; as card; for terminal block width 5 - 17.5 mm; stretchable 5 - 5.2 mm; plain; snap-on type; light green

[www.wago.com/793-5501/000-023](http://www.wago.com/793-5501/000-023)



**Nr. articol: 793-5501/000-024**

WMB marking card; as card; for terminal block width 5 - 17.5 mm; stretchable 5 - 5.2 mm; plain; snap-on type; violet

[www.wago.com/793-5501/000-024](http://www.wago.com/793-5501/000-024)

## Descărcări

### Documentation

#### Additional Information

Technical explanations	Apr 3, 2019	pdf 2,1 MB	Descărcare
------------------------	-------------	---------------	------------

## CAD/CAE-Data

### CAD data

2D/3D Models 280-686	URL	Descărcare
----------------------	-----	------------

### CAE data

EPLAN Data Portal 280-686	URL	Descărcare
---------------------------	-----	------------

WSCAD Universe 280-686	URL	Descărcare
------------------------	-----	------------

## Installation Notes

Supus modificărilor.

WAGO Kontakttechnik GmbH & Co. KG  
 /Representative Office Romania  
 Sos. Pipera-Tunari nr. 1/1  
 building 1, 2nd floor | 077190 Voluntari, Ilfov  
 Tel.: +40-(0)31 421 85 68 | Email: [info-RO@wago.com](mailto:info-RO@wago.com)

Aveți întrebări despre produsele noastre?  
 Vă stăm la dispoziție pentru preluarea apelului la +40 (0) 31 421 85 68.