

Fișă tehnică | Număr articol: 773-332

Mounting carrier; 773 Series - 2.5 mm² / 4 mm² / 6 mm²; for DIN-35 rail mounting/screw mounting; orange

www.wago.com/773-332

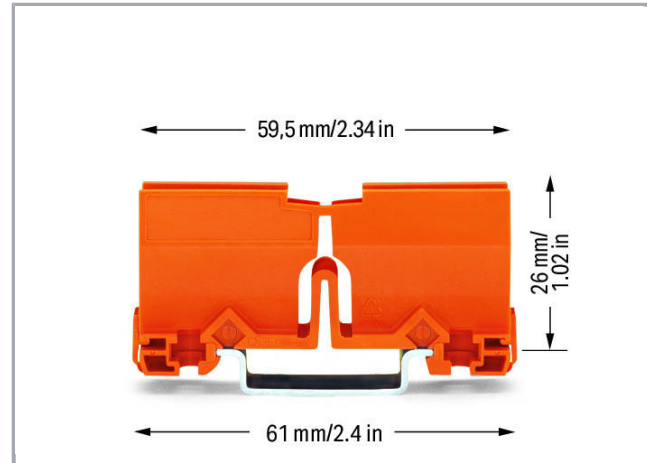

RoHS Compliant

[BOMcheck.net](https://www.bomcheck.net)

Culoare: ■

Date

Geometrical Data

Width	18 mm / 0.709 inch
Height from upper-edge of DIN-rail	26 mm / 1.024 inch
Depth	61 mm / 2.402 inch

Material Data

Color	orange
Fire load	0,255 MJ
Weight	8,5 g

Commercial data

Product Group	7 (Push Wire Conn.)
Packaging type	BOX
Country of origin	DE
GTIN	4044918526524
Customs tariff number	39269097900

Supus modificărilor.

WAGO Kontakttechnik GmbH & Co. KG
/Representative Office Romania
Sos. Pipera-Tunari nr. 1/1
building 1, 2nd floor | 077190 Voluntari, Ilfov
Tel.: +40-(0)31 421 85 68 | Email: info-RO@wago.com

Aveți întrebări despre produsele noastre?
Vă stăm la dispoziție pentru preluarea apelului la +40 (0) 31 421 85 68.

Counterpart

Produse compatibile

Marking accessories

**Nr. articol: 210-834**







Marking strips; on reel; 5 mm wide; plain; Self-adhesive; white

www.wago.com/210-834

General accessories

**Nr. articol: 773-102**PUSH WIRE® connector for junction boxes; for solid and stranded conductors; max. 2.5 mm²; 2-conductor; transparent housing; yellow cover; Surrounding air temperature: max 60°C; 2,50 mm²www.wago.com/773-102**Nr. articol: 773-104**PUSH WIRE® connector for junction boxes; for solid and stranded conductors; max. 2.5 mm²; 4-conductor; transparent housing; orange cover; Surrounding air temperature: max 60°C; 2,50 mm²www.wago.com/773-104**Nr. articol: 773-106**PUSH WIRE® connector for junction boxes; for solid and stranded conductors; max. 2.5 mm²; 6-conductor; transparent housing; violet cover; Surrounding air temperature: max 60°C; 2,50 mm²www.wago.com/773-106**Nr. articol: 773-108**PUSH WIRE® connector for junction boxes; for solid and stranded conductors; max. 2.5 mm²; 8-conductor; transparent housing; dark gray cover; Surrounding air temperature: max 60°C; 2,50 mm²www.wago.com/773-108**Nr. articol: 773-112**PUSH WIRE® connector for junction boxes; for solid and stranded conductors; max. 2.5 mm²; 2-conductor; transparent housing; green cover; Surrounding air temperature: max 60°C; 2,50 mm²www.wago.com/773-112**Nr. articol: 773-114**PUSH WIRE® connector for junction boxes; for solid and stranded conductors; max. 2.5 mm²; 4-conductor; transparent housing; green cover; Surrounding air temperature: max 60°C; 2,50 mm²www.wago.com/773-114**Nr. articol: 773-116**PUSH WIRE® connector for junction boxes; for solid and stranded conductors; max. 2.5 mm²; 6-conductor; transparent housing; green cover; Surrounding air temperature: max 60°C; 2,50 mm²www.wago.com/773-116**Nr. articol: 773-118**PUSH WIRE® connector for junction boxes; for solid and stranded conductors; max. 2.5 mm²; 8-conductor; transparent housing; green cover; Surrounding air temperature: max 60°C; 2,50 mm²www.wago.com/773-118**Nr. articol: 773-124**PUSH WIRE® connector for junction boxes; for solid and stranded conductors; max. 2.5 mm²; 4-conductor; transparent housing; light gray cover; Surrounding air temperature: max 60°C; 2,50 mm²www.wago.com/773-124**Nr. articol: 773-162**PUSH WIRE® connector for junction boxes; for solid and stranded conductors; max. 2.5 mm²; 2-conductor; transparent housing; yellow cover; Surrounding air temperature: max 60°C; 2,50 mm²www.wago.com/773-162**Nr. articol: 773-164**PUSH WIRE® connector for junction boxes; for solid and stranded conductors; max. 2.5 mm²; 4-conductor; transparent housing; orange cover; Surrounding air temperature: max 60°C; 2,50 mm²www.wago.com/773-164**Nr. articol: 773-166**

Supus modificărilor.

	PUSH WIRE® connector for junction boxes; for solid and stranded conductors; max. 2.5 mm ² ; 6-conductor; transparent housing; black cover; Surrounding air temperature: max 60°C; 2,50 mm ²	www.wago.com/773-166
	Nr. articol: 773-168 PUSH WIRE® connector for junction boxes; for solid and stranded conductors; max. 2.5 mm ² ; 8-conductor; transparent housing; dark gray cover; Surrounding air temperature: max 60°C; 2,50 mm ²	www.wago.com/773-168
	Nr. articol: 773-173 PUSH WIRE® connector for junction boxes; for solid and stranded conductors; max. 6 mm ² ; 3-conductor; transparent housing; red cover; Surrounding air temperature: max 60°C; 6,00 mm ²	www.wago.com/773-173
	Nr. articol: 773-514 PUSH WIRE® connector for junction boxes; for solid and stranded conductors; max. 2.5 mm ² ; 4-conductor; Black housing; black cover; Max. surrounding air temperature: 105 °C; 2,50 mm ²	www.wago.com/773-514
	Nr. articol: 773-602 PUSH WIRE® connector for junction boxes; for solid conductors; max. 4 mm ² ; 2-conductor; Brown clear housing; white cover; Surrounding air temperature: max 60°C; 2,50 mm ²	www.wago.com/773-602
	Nr. articol: 773-604 PUSH WIRE® connector for junction boxes; for solid conductors; max. 4 mm ² ; 4-conductor; Brown clear housing; red cover; Surrounding air temperature: max 60°C; 2,50 mm ²	www.wago.com/773-604
	Nr. articol: 773-606 PUSH WIRE® connector for junction boxes; for solid conductors; max. 4 mm ² ; 6-conductor; Brown clear housing; brown cover; Surrounding air temperature: max 60°C; 2,50 mm ²	www.wago.com/773-606

Descărcări

Documentation

Additional Information

Technical explanations	Apr 3, 2019	pdf 2,1 MB	Descărcare
------------------------	-------------	---------------	------------

CAD/CAE-Data

CAD data

2D/3D Models 773-332	URL	Descărcare
----------------------	-----	------------

CAE data

EPLAN Data Portal 773-332	URL	Descărcare
---------------------------	-----	------------

WSCAD Universe 773-332	URL	Descărcare
------------------------	-----	------------

Installation Notes

Assembly

Supus modificărilor.

WAGO Kontakttechnik GmbH & Co. KG
/Representative Office Romania
Sos. Pipera-Tunari nr. 1/1
building 1, 2nd floor | 077190 Voluntari, Ilfov
Tel.: +40-(0)31 421 85 68 | Email: info-RO@wago.com

Aveți întrebări despre produsele noastre?
Vă stăm la dispoziție pentru preluarea apelului la +40 (0) 31 421 85 68.

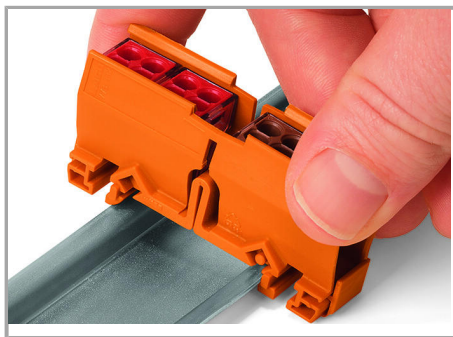

Snap the mounting carrier onto the DIN-rail.



Use the cover as an end plate.

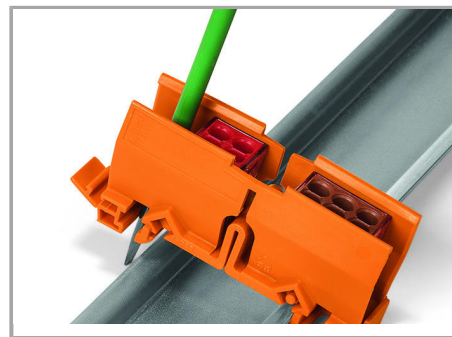

Remove the mounting carrier from the DIN-rail.

Application

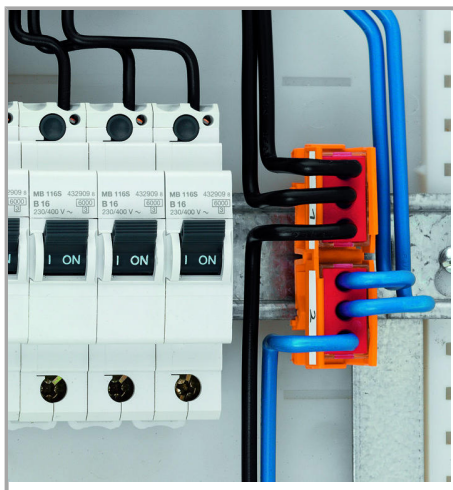

A mounting carrier (see accessories) suits applications where the connectors must be marked and secured in position. The DIN-35 rail-mount carrier fits up to two connectors and can also be mounted on a flat surface using two screws.

Using this PUSH WIRE® connector, a large range of wiring applications can be achieved in distribution or junction boxes. To mention just a few: potential multiplication and changing from or to 6 mm² conductor size.

Supus modificărilor.