

## Fișă tehnică | Număr articol: 769-633/003-036

THT male header; 1.0 x 1.0 mm solder pin; straight; Pin spacing 5 mm; 3-pole; gray

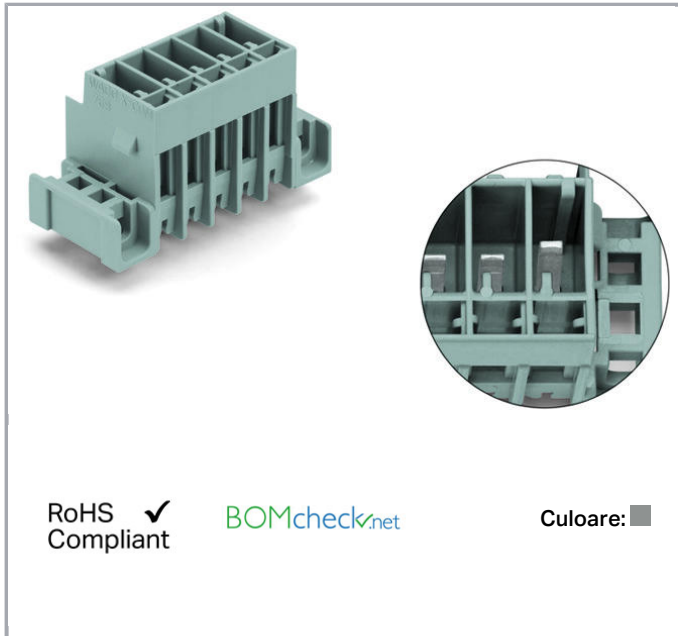

[www.wago.com/769-633/003-036](http://www.wago.com/769-633/003-036)



RoHS  Compliant

BOMcheck.net

Culoare: ■

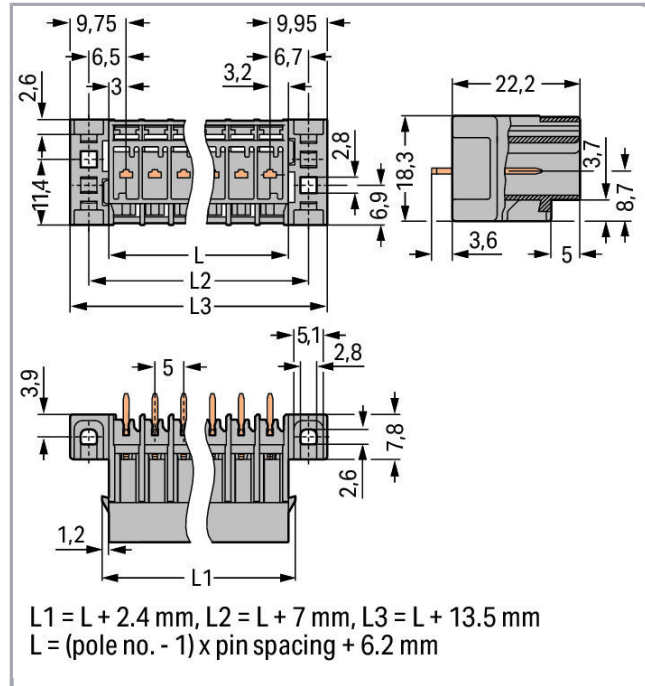

### Date

### Electrical data

### Ratings per IEC/EN 60664-1

Nominal voltage (III/3)	250 V
Rated surge voltage (III/3)	4 kV
Rated voltage (III/2)	500 V
Rated surge voltage (III/2)	4 kV
Rated current	32 A
Legend (ratings)	(III / 3) ≙ Overvoltage category III / Pollution degree 3

### Connection data

Pole No.	3
Total number of potentials	3
Number of levels	1

Supus modificărilor.

WAGO Kontakttechnik GmbH & Co. KG  
 /Representative Office Romania  
 Sos. Pipera-Tunari nr. 1/1  
 building 1, 2nd floor | 077190 Voluntari, Ilfov  
 Tel.: +40-(0)31 421 85 68 | Email: info-RO@wago.com

Aveți întrebări despre produsele noastre?  
 Vă stăm la dispoziție pentru preluarea apelului la +40 (0) 31 421 85 68.



## Geometrical Data

Pin spacing	5 mm / 0.197 inch
Width	29,7 mm / 1.169 inch
Height from the surface	22,2 mm / 0.874 inch
Depth	18,3 mm / 0.72 inch

## Mechanical data

Mounting type	Mounting flange
---------------	-----------------

## Plug connection

Contact type (pluggable connector)	Male connector/plug
Connector (connection type)	for PCB
Mismating protection	No
Mating direction to the PCB	90°

## PCB contact

PCB contact	THT
-------------	-----

## Material Data

Color	gray
Insulation material	Polyamide 66 (PA 66)
Fire load	0,104 MJ
Weight	4,4 g

## Commercial data

Product Group	18 (X-COM-System)
Packaging type	BOX
Country of origin	PL
GTIN	4050821272687
Customs tariff number	85366990990

## Aprobări / certificate

### Country specific Approvals



Emblemă	Aprobare	Text de aprobare suplimentar	Nume certificat
	<b>CSA</b>	C22.2 No. 158	1101144

Supus modificărilor.



DEKRA Certification B.V.

## UL-Approvals

Emblemă	Aprobare	Text de aprobare suplimentar	Nume certificat
	UR Underwriters Laboratories Inc.	UL 1977	20151210- E45171
	UR Underwriters Laboratories Inc.	UL 1059	20190731- E45172





## Counterpart

## Produse compatibile

## Coding

	<b>Nr. articol: 769-435</b> Coding pin; for coding of female plugs; for carrier terminal blocks / male connectors; orange	<a href="http://www.wago.com/769-435">www.wago.com/769-435</a>
--	--	--

## Female plug

	<b>Nr. articol: 769-101</b> 1-conductor female plug; 4 mm <sup>2</sup> ; 1-pole; 4,00 mm <sup>2</sup> ; gray	<a href="http://www.wago.com/769-101">www.wago.com/769-101</a>
	<b>Nr. articol: 769-102</b> 1-conductor female plug; 4 mm <sup>2</sup> ; 2-pole; 4,00 mm <sup>2</sup> ; gray	<a href="http://www.wago.com/769-102">www.wago.com/769-102</a>
	<b>Nr. articol: 769-102/000-036</b> 1-conductor female plug; 4 mm <sup>2</sup> ; 2-pole; 4,00 mm <sup>2</sup> ; gray, green-yellow	<a href="http://www.wago.com/769-102/000-036">www.wago.com/769-102/000-036</a>
	<b>Nr. articol: 769-102/000-037</b> 1-conductor female plug; 4 mm <sup>2</sup> ; 2-pole; 4,00 mm <sup>2</sup> ; green-yellow, gray	<a href="http://www.wago.com/769-102/000-037">www.wago.com/769-102/000-037</a>
	<b>Nr. articol: 769-103</b> 1-conductor female plug; 4 mm <sup>2</sup> ; 3-pole; 4,00 mm <sup>2</sup> ; gray	<a href="http://www.wago.com/769-103">www.wago.com/769-103</a>

Supus modificărilor.

WAGO Kontakttechnik GmbH & Co. KG  
/Representative Office Romania  
Sos. Pipera-Tunari nr. 1/1  
building 1, 2nd floor | 077190 Voluntari, Ilfov  
Tel.: +40-(0)31 421 85 68 | Email: info-RO@wago.com

Aveți întrebări despre produsele noastre?  
Vă stăm la dispoziție pentru preluarea apelului la +40 (0) 31 421 85 68.



**Nr. articol: 769-103/000-036**

1-conductor female plug; 4 mm<sup>2</sup>; 3-pole; 4,00 mm<sup>2</sup>; gray, green-yellow

[www.wago.com/769-103/000-036](http://www.wago.com/769-103/000-036)



**Nr. articol: 769-103/000-037**

1-conductor female plug; 4 mm<sup>2</sup>; 3-pole; 4,00 mm<sup>2</sup>; green-yellow, gray

[www.wago.com/769-103/000-037](http://www.wago.com/769-103/000-037)



**Nr. articol: 769-103/000-038**

1-conductor female plug; 4 mm<sup>2</sup>; 3-pole; 4,00 mm<sup>2</sup>; gray, blue, green-yellow

[www.wago.com/769-103/000-038](http://www.wago.com/769-103/000-038)



**Nr. articol: 769-103/000-039**

1-conductor female plug; 4 mm<sup>2</sup>; 3-pole; 4,00 mm<sup>2</sup>; green-yellow, blue, gray

[www.wago.com/769-103/000-039](http://www.wago.com/769-103/000-039)



**Nr. articol: 769-103/021-000**

1-conductor female plug; Locking lever; 4 mm<sup>2</sup>; 3-pole; 4,00 mm<sup>2</sup>; gray

[www.wago.com/769-103/021-000](http://www.wago.com/769-103/021-000)



**Nr. articol: 769-121**

2-conductor female connector; 4 mm<sup>2</sup>; 1-pole; 4,00 mm<sup>2</sup>; gray

[www.wago.com/769-121](http://www.wago.com/769-121)



**Nr. articol: 769-122**

2-conductor female connector; 4 mm<sup>2</sup>; 2-pole; 4,00 mm<sup>2</sup>; gray

[www.wago.com/769-122](http://www.wago.com/769-122)



**Nr. articol: 769-123**

2-conductor female connector; 4 mm<sup>2</sup>; 3-pole; 4,00 mm<sup>2</sup>; gray

[www.wago.com/769-123](http://www.wago.com/769-123)

## Descărcări

### Documentation

#### Additional Information

Technical explanations

Apr 3, 2019

pdf  
2,1 MB

Descărcare

### CAD/CAE-Data

#### CAE data

WSCAD Universe 769-633/003-036

URL

Descărcare

#### PCB Design

Symbol and Footprint 769-633/003-036

URL

Descărcare

CAX data for your PCB design, consisting of "schematic symbols and PCB footprints", allow easy integration of the WAGO component into your development environment.

Supus modificărilor.

WAGO Kontakttechnik GmbH & Co. KG  
/Representative Office Romania  
Sos. Pipera-Tunari nr. 1/1  
building 1, 2nd floor | 077190 Voluntari, Ilfov  
Tel.: +40-(0)31 421 85 68 | Email: info-RO@wago.com

Aveți întrebări despre produsele noastre?  
Vă stăm la dispoziție pentru preluarea apelului la +40 (0) 31 421 85 68.

#### Supported formats:

- Accel EDA 14 & 15
- Altium 6 to current version
- Cadence Allegro
- DesignSpark
- Eagle Libraries
- KiCad
- Mentor Graphics BoardStation
- Mentor Graphics Design Architect
- Mentor Graphics Design Expedition 99 and 2000
- OrCAD 9.X PCB and Capture
- PADS PowerPCB 3, 3.5, 4.X, and 5.X
- PADS PowerPCB and PowerLogic 3.0
- PCAD 2000, 2001, 2002, 2004, and 2006
- Pulsonix 8.5 or newer
- STL
- 3D STEP
- TARGET 3001!
- View Logic ViewDraw
- Quadcept
- Zuken CadStar 3 and 4
- Zuken CR-5000 and CR-8000

PCB Component Libraries (EDA), PCB CAD Library Ultra Librarian

---

#### Installation Notes

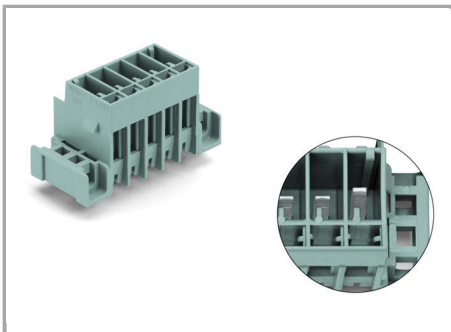

#### Application

Supus modificărilor.

---

WAGO Kontakttechnik GmbH & Co. KG  
/Representative Office Romania  
Sos. Pipera-Tunari nr. 1/1  
building 1, 2nd floor | 077190 Voluntari, Ilfov  
Tel.: +40-(0)31 421 85 68 | Email: info-RO@wago.com

Aveți întrebări despre produsele noastre?  
Vă stăm la dispoziție pentru preluarea apelului la +40 (0) 31 421 85 68.

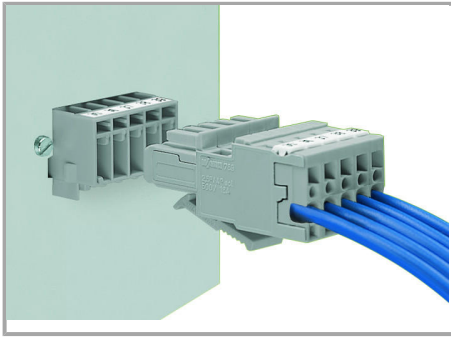

Male header with mounting flanges

1-conductor female plug with bottom-mount locking levers

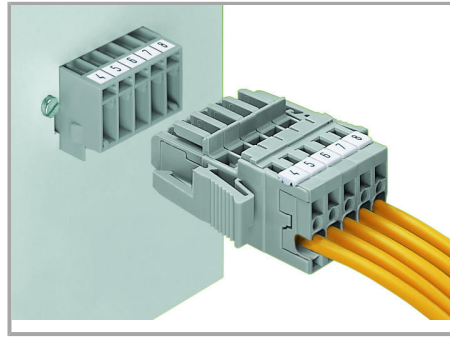

Male header with mounting flanges

1-conductor female plug with lateral locking levers

## Familie de produse

### X-COM

[Afișare globală produse din familie.](#)

Supus modificărilor.