

# Fișă tehnică | Număr articol: 769-636/003-000

THT male header; 1.0 x 1.0 mm solder pin; straight; clamping collar; Pin spacing 5 mm; 6-pole; gray



[www.wago.com/769-636/003-000](http://www.wago.com/769-636/003-000)



RoHS  Compliant

BOMcheck.net

Culoare: ■

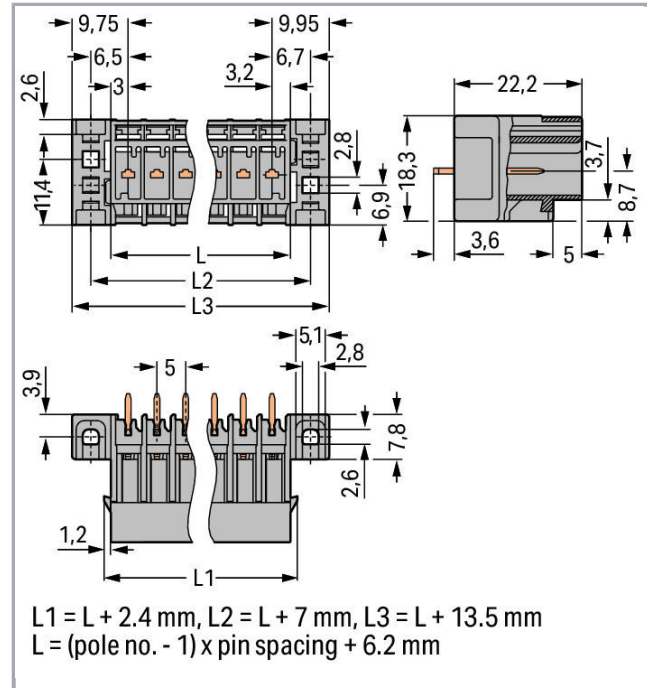

## Date

### Electrical data

### Ratings per IEC/EN 60664-1

Nominal voltage (III/3)	250 V
Rated surge voltage (III/3)	4 kV
Rated voltage (III/2)	500 V
Rated surge voltage (III/2)	4 kV
Rated current	32 A
Legend (ratings)	(III / 3) $\triangleq$ Overvoltage category III / Pollution degree 3

Supus modificărilor.

WAGO Kontakttechnik GmbH & Co. KG  
/Representative Office Romania  
Sos. Pipera-Tunari nr. 1/1  
building 1, 2nd floor | 077190 Voluntari, Ilfov  
Tel.: +40-(0)31 421 85 68 | Email: info-RO@wago.com

Aveți întrebări despre produsele noastre?  
Vă stăm la dispoziție pentru preluarea apelului la +40 (0) 31 421 85 68.

**Connection data**

Pole No.	6
Total number of potentials	6
Number of levels	1

**Geometrical Data**

Pin spacing	5 mm / 0.197 inch
Width	44,7 mm / 1.76 inch
Height from the surface	22,2 mm / 0.874 inch
Depth	18,3 mm / 0.72 inch

**Mechanical data**

Mounting type	Mounting flange
---------------	-----------------

**Plug connection**

Contact type (pluggable connector)	Male connector/plug
Connector (connection type)	for PCB
Mismating protection	No
Mating direction to the PCB	90°

**PCB contact**

PCB contact	THT
-------------	-----

**Material Data**

Color	gray
Insulation material	Polyamide 66 (PA 66)
Fire load	0,16 MJ
Weight	7,1 g

**Commercial data**

Product Group	18 (X-COM-System)
Packaging type	BOX
Country of origin	PL
GTIN	4044918270694

Supus modificărilor.

WAGO Kontakttechnik GmbH & Co. KG  
 /Representative Office Romania  
 Sos. Pipera-Tunari nr. 1/1  
 building 1, 2nd floor | 077190 Voluntari, Ilfov  
 Tel.: +40-(0)31 421 85 68 | Email: info-RO@wago.com

Aveți întrebări despre produsele noastre?  
 Vă stăm la dispoziție pentru preluarea apelului la +40 (0) 31 421 85 68.

Customs tariff number

85366990990

## Aprobări / certificate



## Country specific Approvals

Emblemă	Aprobare	Text de aprobare suplimentar	Nume certificat
	<b>CCA</b> DEKRA Certification B.V.	EN 60947	NTR NL-7626
	<b>CCA</b> DEKRA Certification B.V.	EN 61984	2190419.02
	<b>CSA</b> DEKRA Certification B.V.	C22.2 No. 158	1101144
	<b>KEMA/KEUR</b> DEKRA Certification B.V.	EN 60947	2190419.01

## Ship Approvals

Emblemă	Aprobare	Text de aprobare suplimentar	Nume certificat
	<b>DNV GL</b> Det Norske Veritas, Germanischer Lloyd	-	TAE00001V2

## UL-Approvals

Emblemă	Aprobare	Text de aprobare suplimentar	Nume certificat
	<b>UR</b> Underwriters Laboratories Inc.	UL 1977	20151210-E45171
	<b>UR</b> Underwriters Laboratories Inc.	UL 1059	20190731-E45172

Supus modificărilor.

WAGO Kontakttechnik GmbH & Co. KG  
/Representative Office Romania  
Sos. Pipera-Tunari nr. 1/1  
building 1, 2nd floor | 077190 Voluntari, Ilfov  
Tel.: +40-(0)31 421 85 68 | Email: info-RO@wago.com

Aveți întrebări despre produsele noastre?  
Vă stăm la dispoziție pentru preluarea apelului la +40 (0) 31 421 85 68.

## Counterpart

## Produse compatibile

## Coding

**Nr. articol: 769-435**















Coding pin; for coding of female plugs; for carrier terminal blocks / male connectors; orange

[www.wago.com/769-435](http://www.wago.com/769-435)

## Female plug

**Nr. articol: 769-101**1-conductor female plug; 4 mm<sup>2</sup>; 1-pole; 4,00 mm<sup>2</sup>; gray[www.wago.com/769-101](http://www.wago.com/769-101)**Nr. articol: 769-102**1-conductor female plug; 4 mm<sup>2</sup>; 2-pole; 4,00 mm<sup>2</sup>; gray[www.wago.com/769-102](http://www.wago.com/769-102)**Nr. articol: 769-102/000-036**1-conductor female plug; 4 mm<sup>2</sup>; 2-pole; 4,00 mm<sup>2</sup>; gray, green-yellow[www.wago.com/769-102/000-036](http://www.wago.com/769-102/000-036)**Nr. articol: 769-102/000-037**1-conductor female plug; 4 mm<sup>2</sup>; 2-pole; 4,00 mm<sup>2</sup>; green-yellow, gray[www.wago.com/769-102/000-037](http://www.wago.com/769-102/000-037)**Nr. articol: 769-103**1-conductor female plug; 4 mm<sup>2</sup>; 3-pole; 4,00 mm<sup>2</sup>; gray[www.wago.com/769-103](http://www.wago.com/769-103)**Nr. articol: 769-103/000-036**1-conductor female plug; 4 mm<sup>2</sup>; 3-pole; 4,00 mm<sup>2</sup>; gray, green-yellow[www.wago.com/769-103/000-036](http://www.wago.com/769-103/000-036)**Nr. articol: 769-103/000-037**1-conductor female plug; 4 mm<sup>2</sup>; 3-pole; 4,00 mm<sup>2</sup>; green-yellow, gray[www.wago.com/769-103/000-037](http://www.wago.com/769-103/000-037)**Nr. articol: 769-103/000-038**1-conductor female plug; 4 mm<sup>2</sup>; 3-pole; 4,00 mm<sup>2</sup>; gray, blue, green-yellow[www.wago.com/769-103/000-038](http://www.wago.com/769-103/000-038)**Nr. articol: 769-103/000-039**1-conductor female plug; 4 mm<sup>2</sup>; 3-pole; 4,00 mm<sup>2</sup>; green-yellow, blue, gray[www.wago.com/769-103/000-039](http://www.wago.com/769-103/000-039)**Nr. articol: 769-104**1-conductor female plug; 4 mm<sup>2</sup>; 4-pole; 4,00 mm<sup>2</sup>; gray[www.wago.com/769-104](http://www.wago.com/769-104)**Nr. articol: 769-104/000-036**1-conductor female plug; 4 mm<sup>2</sup>; 4-pole; 4,00 mm<sup>2</sup>; gray, green-yellow[www.wago.com/769-104/000-036](http://www.wago.com/769-104/000-036)

Supus modificărilor.

	<b>Nr. articol: 769-104/000-037</b> 1-conductor female plug; 4 mm <sup>2</sup> ; 4-pole; 4,00 mm <sup>2</sup> ; green-yellow, gray	<a href="http://www.wago.com/769-104/000-037">www.wago.com/769-104/000-037</a>
	<b>Nr. articol: 769-104/000-038</b> 1-conductor female plug; 4 mm <sup>2</sup> ; 4-pole; 4,00 mm <sup>2</sup> ; gray, blue, green-yellow	<a href="http://www.wago.com/769-104/000-038">www.wago.com/769-104/000-038</a>
	<b>Nr. articol: 769-104/000-039</b> 1-conductor female plug; 4 mm <sup>2</sup> ; 4-pole; 4,00 mm <sup>2</sup> ; green-yellow, blue, gray	<a href="http://www.wago.com/769-104/000-039">www.wago.com/769-104/000-039</a>
	<b>Nr. articol: 769-105</b> 1-conductor female plug; 4 mm <sup>2</sup> ; 5-pole; 4,00 mm <sup>2</sup> ; gray	<a href="http://www.wago.com/769-105">www.wago.com/769-105</a>
	<b>Nr. articol: 769-105/000-036</b> 1-conductor female plug; 4 mm <sup>2</sup> ; 5-pole; 4,00 mm <sup>2</sup> ; gray, green-yellow	<a href="http://www.wago.com/769-105/000-036">www.wago.com/769-105/000-036</a>
	<b>Nr. articol: 769-105/000-037</b> 1-conductor female plug; 4 mm <sup>2</sup> ; 5-pole; 4,00 mm <sup>2</sup> ; green-yellow, gray	<a href="http://www.wago.com/769-105/000-037">www.wago.com/769-105/000-037</a>
	<b>Nr. articol: 769-105/000-038</b> 1-conductor female plug; 4 mm <sup>2</sup> ; 5-pole; 4,00 mm <sup>2</sup> ; gray, blue, green-yellow	<a href="http://www.wago.com/769-105/000-038">www.wago.com/769-105/000-038</a>
	<b>Nr. articol: 769-105/000-039</b> 1-conductor female plug; 4 mm <sup>2</sup> ; 5-pole; 4,00 mm <sup>2</sup> ; green-yellow, blue, gray	<a href="http://www.wago.com/769-105/000-039">www.wago.com/769-105/000-039</a>
	<b>Nr. articol: 769-106</b> 1-conductor female plug; 4 mm <sup>2</sup> ; 6-pole; 4,00 mm <sup>2</sup> ; gray	<a href="http://www.wago.com/769-106">www.wago.com/769-106</a>
	<b>Nr. articol: 769-106/000-006</b> 1-conductor female plug; 4 mm <sup>2</sup> ; 6-pole; 4,00 mm <sup>2</sup> ; blue	<a href="http://www.wago.com/769-106/000-006">www.wago.com/769-106/000-006</a>
	<b>Nr. articol: 769-106/000-036</b> 1-conductor female plug; 4 mm <sup>2</sup> ; 6-pole; 4,00 mm <sup>2</sup> ; gray, green-yellow	<a href="http://www.wago.com/769-106/000-036">www.wago.com/769-106/000-036</a>
	<b>Nr. articol: 769-106/000-037</b> 1-conductor female plug; 4 mm <sup>2</sup> ; 6-pole; 4,00 mm <sup>2</sup> ; green-yellow, gray	<a href="http://www.wago.com/769-106/000-037">www.wago.com/769-106/000-037</a>
	<b>Nr. articol: 769-106/000-038</b> 1-conductor female plug; 4 mm <sup>2</sup> ; 6-pole; 4,00 mm <sup>2</sup> ; gray, blue, green-yellow	<a href="http://www.wago.com/769-106/000-038">www.wago.com/769-106/000-038</a>
	<b>Nr. articol: 769-106/000-039</b> 1-conductor female plug; 4 mm <sup>2</sup> ; 6-pole; 4,00 mm <sup>2</sup> ; green-yellow, blue, gray	<a href="http://www.wago.com/769-106/000-039">www.wago.com/769-106/000-039</a>

Supus modificărilor.

	<b>Nr. articol: 769-106/021-000</b> 1-conductor female plug; Locking lever; 4 mm <sup>2</sup> ; 6-pole; 4,00 mm <sup>2</sup> ; gray	<a href="http://www.wago.com/769-106/021-000">www.wago.com/769-106/021-000</a>
	<b>Nr. articol: 769-121</b> 2-conductor female connector; 4 mm <sup>2</sup> ; 1-pole; 4,00 mm <sup>2</sup> ; gray	<a href="http://www.wago.com/769-121">www.wago.com/769-121</a>
	<b>Nr. articol: 769-122</b> 2-conductor female connector; 4 mm <sup>2</sup> ; 2-pole; 4,00 mm <sup>2</sup> ; gray	<a href="http://www.wago.com/769-122">www.wago.com/769-122</a>
	<b>Nr. articol: 769-123</b> 2-conductor female connector; 4 mm <sup>2</sup> ; 3-pole; 4,00 mm <sup>2</sup> ; gray	<a href="http://www.wago.com/769-123">www.wago.com/769-123</a>
	<b>Nr. articol: 769-124</b> 2-conductor female connector; 4 mm <sup>2</sup> ; 4-pole; 4,00 mm <sup>2</sup> ; gray	<a href="http://www.wago.com/769-124">www.wago.com/769-124</a>
	<b>Nr. articol: 769-125</b> 2-conductor female connector; 4 mm <sup>2</sup> ; 5-pole; 4,00 mm <sup>2</sup> ; gray	<a href="http://www.wago.com/769-125">www.wago.com/769-125</a>
	<b>Nr. articol: 769-126</b> 2-conductor female connector; 4 mm <sup>2</sup> ; 6-pole; 4,00 mm <sup>2</sup> ; gray	<a href="http://www.wago.com/769-126">www.wago.com/769-126</a>

**Marking accessories**

	<b>Nr. articol: 210-831</b> Marking strips; on reel; 2.3 mm wide; plain; Self-adhesive; white	<a href="http://www.wago.com/210-831">www.wago.com/210-831</a>
	<b>Nr. articol: 210-832</b> Marking strips; on reel; 3 mm wide; plain; Self-adhesive; white	<a href="http://www.wago.com/210-832">www.wago.com/210-832</a>
	<b>Nr. articol: 210-833</b> Marking strips; on reel; 6 mm wide; plain; Self-adhesive; white	<a href="http://www.wago.com/210-833">www.wago.com/210-833</a>
	<b>Nr. articol: 210-834</b> Marking strips; on reel; 5 mm wide; plain; Self-adhesive; white	<a href="http://www.wago.com/210-834">www.wago.com/210-834</a>

**Descărcări****Documentation****Additional Information**

Technical explanations	Apr 3, 2019	pdf 2,1 MB	Descărcare
------------------------	-------------	---------------	------------

**CAD/CAE-Data****CAD data**

2D/3D Models 769-636/003-000	URL	Descărcare
------------------------------	-----	------------

**PCB Design**

Supus modificărilor.

WAGO Kontakttechnik GmbH & Co. KG  
/Representative Office Romania  
Sos. Pipera-Tunari nr. 1/1  
building 1, 2nd floor | 077190 Voluntari, Ilfov  
Tel.: +40-(0)31 421 85 68 | Email: info-RO@wago.com

Aveți întrebări despre produsele noastre?  
Vă stăm la dispoziție pentru preluarea apelului la +40 (0) 31 421 85 68.



[URL](#)

[Descărcare](#)

Symbol and Footprint 769-636/003-000

CAX data for your PCB design, consisting of "schematic symbols and PCB footprints", allow easy integration of the WAGO component into your development environment.

#### Supported formats:

- Accel EDA 14 & 15
- Altium 6 to current version
- Cadence Allegro
- DesignSpark
- Eagle Libraries
- KiCad
- Mentor Graphics BoardStation
- Mentor Graphics Design Architect
- Mentor Graphics Design Expedition 99 and 2000
- OrCAD 9.X PCB and Capture
- PADS PowerPCB 3, 3.5, 4.X, and 5.X
- PADS PowerPCB and PowerLogic 3.0
- PCAD 2000, 2001, 2002, 2004, and 2006
- Pulsonix 8.5 or newer
- STL
- 3D STEP
- TARGET 3001!
- View Logic ViewDraw
- Quadcept
- Zuken CadStar 3 and 4
- Zuken CR-5000 and CR-8000

PCB Component Libraries (EDA), PCB CAD Library Ultra Librarian

---

## Installation Notes

### Application

Supus modificărilor.

---

WAGO Kontakttechnik GmbH & Co. KG  
/Representative Office Romania  
Sos. Pipera-Tunari nr. 1/1  
building 1, 2nd floor | 077190 Voluntari, Ilfov  
Tel.: +40-(0)31 421 85 68 | Email: info-RO@wago.com

Aveți întrebări despre produsele noastre?  
Vă stăm la dispoziție pentru preluarea apelului la +40 (0) 31 421 85 68.

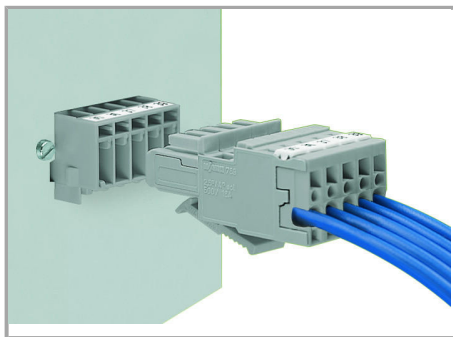

Male header with mounting flanges

1-conductor female plug with bottom-mount locking levers

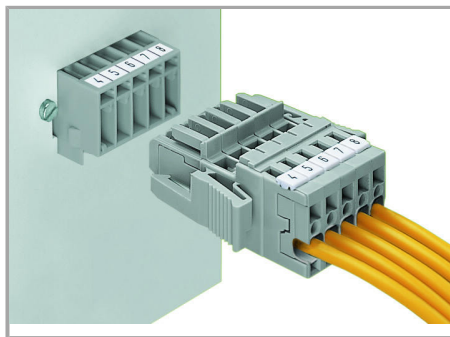

Male header with mounting flanges

1-conductor female plug with lateral locking levers

## Familie de produse

### X-COM

[Afișare globală produse din familie.](#)

Supus modificărilor.